

Lighting Controls

DALI XC

Manual

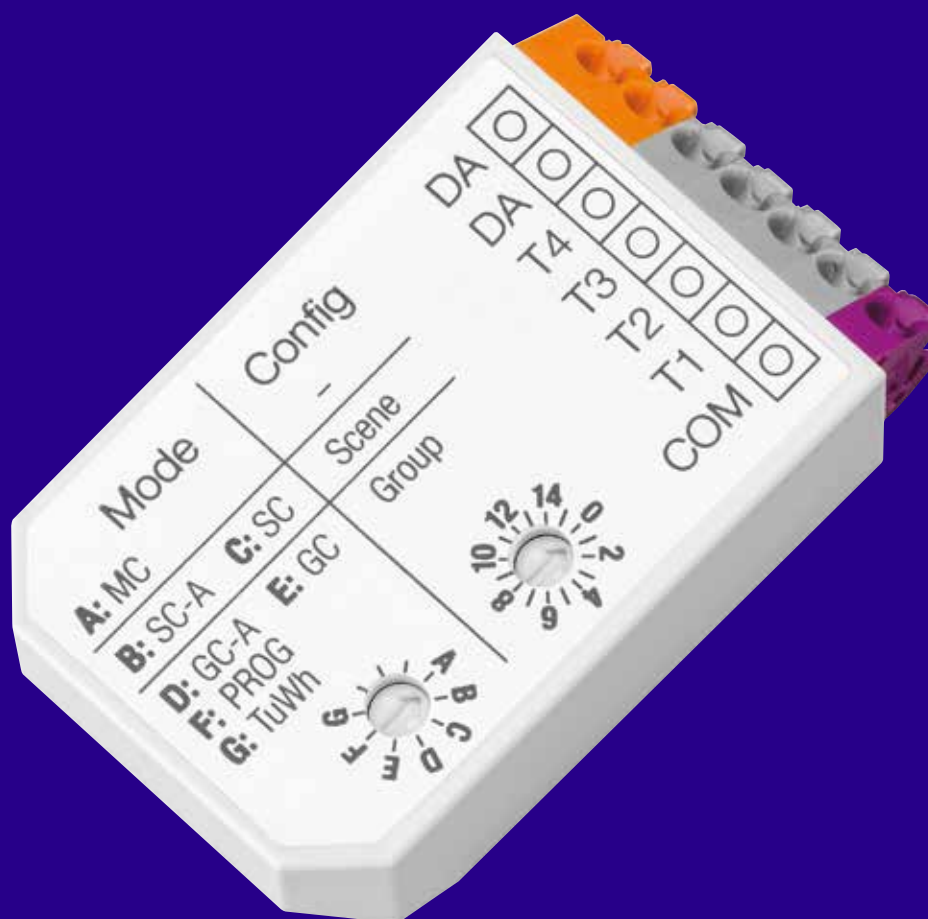

TRIDONIC

Copyright

Copyright © Tridonic GmbH & Co KG
All rights reserved.

Manufacturer

Tridonic GmbH & Co KG
Färbergasse 15
6851 Dornbirn
Austria
Tel. +43-(0)5572-395-0
Fax +43-(0)5572-20176
www.tridonic.com

Document number

DALI XC_IB 4.1 | 06.2020 | en

Table of contents

1	How to use this manual	4
2	Safety instructions	5
3	Device description	6
	3.1 <i>Application area</i>	7
	3.2 <i>Operating modes</i>	7
	3.3 <i>Acoustic signals</i>	8
4	Project design	9
5	Commissioning	13
	5.1 <i>Starting commissioning</i>	14
	5.2 <i>Grouping luminaires</i>	16
	5.3 <i>Finishing commissioning</i>	17
6	Saving scenes	18
7	Regrouping luminaires	19
8	Operation	22
	8.1 <i>Changing intensity</i>	22
	8.1.1 <i>Single momentary-action switch control.....</i>	22
	8.1.2 <i>Double momentary-action switch control.....</i>	23
	8.2 <i>Changing colour temperature</i>	24
	8.3 <i>Recalling scenes</i>	24
9	System extension	25
	9.1 <i>Starting system extension</i>	25
	9.2 <i>Adding or changing luminaires</i>	27
	9.3 <i>Adding or changing DALI XC devices</i>	28
	9.4 <i>Finishing system extension</i>	29
10	Technical data	30

1 How to use this manual

We are pleased that you have chosen this Tridonic GmbH & Co KG product. So that you can get the most from this manual, the following information will be set out in this section:

- Characters and symbols in this manual
- Further information



Note

These commissioning instructions describe how to use the DALI XC in the **comfortDIM** system.

Characters and symbols in this manual

The following characters and symbols are used in this manual:

Character/ symbol	Description
1.	Individual steps in the instructions are numbered.
▷	Single-step instructions are indicated by ▷ at the beginning of the line.
↻	After a step has been described, a description of the expected results will follow. These results are indicated by ↻ at the beginning of the line.
—	Requirements which need to be checked before carrying out a step are indicated by —.
i	Notes can be recognised by i . In addition, notes are identified by the word Note .

Table 1: Characters and symbols in this manual

Further information

More information on installing the DALI XC can be found in the installation instructions supplied with the device.

General information on our products can be found on our website: www.tridonic.com

2 Safety instructions

- The device may only be used for the application area specified.
- Relevant health and safety regulations must be observed.
- When assembling and installing the device, the voltage supply must be disconnected.
- Only qualified personnel may assemble, install and commission the device.
- If an error occurs, dangerous voltage levels may be present at the DALI terminals and on the DALI control line.

3 Device description

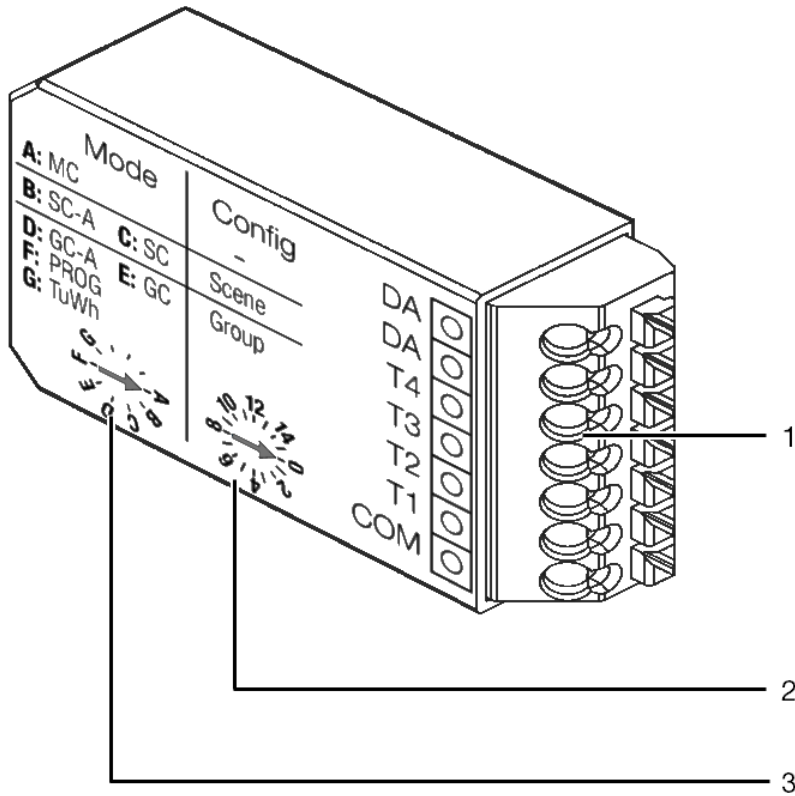

Figure 1: DALI XC input device

- (1) Terminals
- (2) "Config" rotary selector switch
- (3) "Mode" rotary selector switch

3.1 Application area

The DALI XC is a device with four inputs for controlling lighting with single momentary-action switches, double momentary-action switches and standard switches, which can be combined in some operating modes. The DALI XC is supplied by the DALI control line. For this reason, a device that provides the voltage supply is required for use in a lighting system (e.g. DALI PS2).

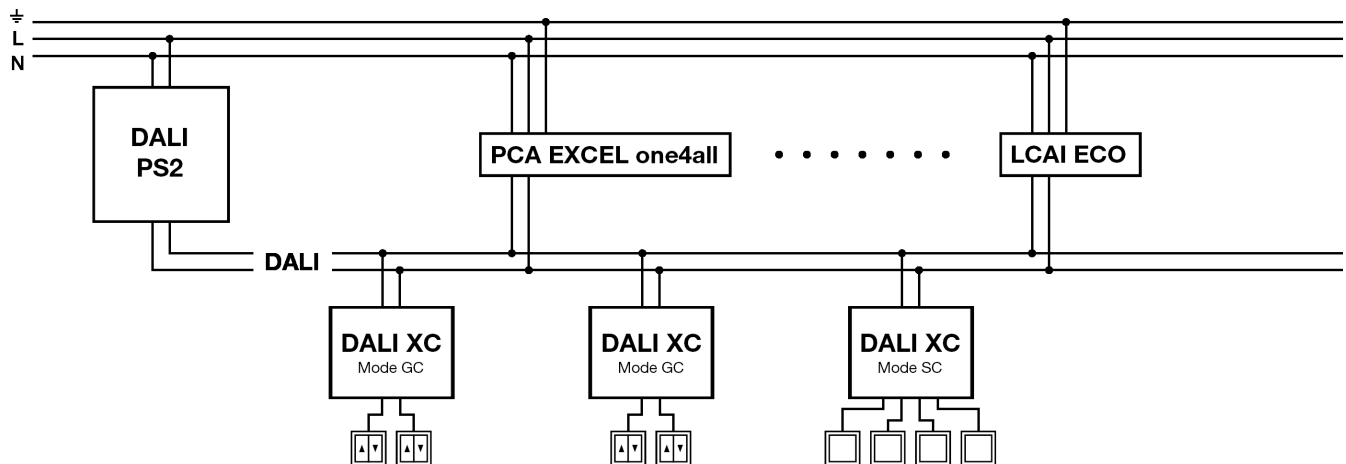

Figure 2: DALI XC in a lighting system as part of the comfortDIM system

3.2 Operating modes

The **Mode** rotary selector switch is used to set the operating mode. Every letter A–G on the **Mode** rotary selector switch stands for an operating mode specified on the device. If the rotary selector switch is not turned to a marked position, the DALI XC will not function.

"MC" operating mode

Rotary selector switch position A

Single momentary-action switches and/or double momentary-action switches and/or standard switches can be used to recall programmed functions. The **MC** operating mode can only be configured using the masterCONFIGURATOR software versions 2.10 and higher. The device does not function in **MC** operating mode by default.



Note

More information can be found in the masterCONFIGURATOR software user manual installed with the software. The user manual can also be downloaded from the Tridonic website.

A DALI XC device in **MC** operating mode can replace the DALI MC (art. No 86458507).

"SC-A" operating mode

Rotary selector switch position B

Single momentary-action switches can be used to recall scenes. No scenes can be saved in this operating mode.

A DALI XC device in **SC-A** operating mode can replace the DALI SC-A (art. No 24138906).

"SC" operating mode

Rotary selector switch position C

Single momentary-action switches can be used to recall and save scenes.

A DALI XC device in **SC** operating mode can replace the DALI SC (art. No 24034263).

"GC-A" operating mode

Rotary selector switch position D

Single momentary-action switches and/or double momentary-action switches can be used to switch luminaire groups on/off and brighten or dim them. Programming mode cannot be enabled in the operating mode. If the lighting system is switched to programming mode using another DALI XC device, the momentary-action switches connected to the DALI XC in **GC-A** operating mode can be used to group luminaires.

A DALI XC device in **GC-A** operating mode can replace the DALI GC-A (art. No 24138907).

"GC" operating mode

Rotary selector switch position E

Single momentary-action switches and/or double momentary-action switches can be used to switch luminaire groups on/off and brighten or dim them. A system extension is typically started in this operating mode. If the lighting system is in programming mode, the momentary-action switches connected to the DALI XC in **GC** operating mode can be used to group luminaires.

A DALI XC device in **GC** operating mode can replace the DALI GC (art. No 24033450).

"Prog" operating mode

Rotary selector switch position F

Commissioning or a system extension can be started and completed in this operating mode. The lighting system is in programming mode while these processes are ongoing.

"TuWh" operating mode

Rotary selector switch position G

Double momentary-action switches can be used to set the intensity and colour temperature of Tunable White luminaires.

3.3 Acoustic signals

Some actions on the DALI XC elicit a different number of high beeps. During configuration, beeping indicates that some steps have been reached.

- The DALI XC beeps three times when the voltage supply has been established.
- In programming mode, the DALI XC beeps once each time a momentary-action switch is pressed.
- The DALI XC beeps once, twice or three times after various configuration steps.
- The DALI XC beeps once after approx. 1 s when one of the rotary selector switches is turned to a new position.

4 Project design

The following conditions apply for the project design of a lighting system with DALI XC:

- No more than 64 DALI-compatible control gear elements can be used.
- No more than 16 groups can be configured.
- A luminaire can be assigned to max. 16 groups.
- No more than 16 scenes can be configured.

i

Note

The maximum number of DALI XC devices that can be used in a lighting system depends on the total power consumption of the devices connected to the DALI control line. The power consumption of the individual devices can be found in the associated data sheets.

The following information applies to the use of the DALI XC in the **comfortDIM** system.

Assigning groups to inputs (DALI XC in "GC-A" or "GC" operating mode)

Rotary selector switch position D or E

The **Config** rotary selector switch is used to assign different groups to input T1 and T2 and input T3 and T4. The following table uses the rotary selector switch position to indicate which group is assigned to the inputs.

Commands send out:

T1 ... short press = DALI Command 0 = OFF

long press = DALI Command 2 = DOWN

T2 ... short press = DALI Comannd 5 = Recall max. level

long press = DALI Command 1 = UP

T3 ... short press = DALI Command 0 = OFF

long press = DALI Command 2 = DOWN

T4 ... short press = DALI Command 5 = Recall max. level

long press = DALI Command 1 = UP

Rotary selector switch position	Group	
	Input T1 and T2	Input T3 and T4
0	all	0
1	0	1
2	1	2
3	2	3
4	3	4
5	4	5
6	5	6
7	6	7
8	7	8
9	8	9
10	9	10
11	10	11
12	11	12
13	12	13
14	13	14
15	14	15

Table 2: Assigning groups to inputs (DALI XC in "GC-A" or "GC" operating mode)

Assigning groups to inputs (DALI XC in "TuWh" operating mode)

Rotary selector switch position G

The **Config** rotary selector switch is used to assign a group to all inputs. The intensity of the group can be changed with input T1 and T2 and the colour temperature of Tunable White luminaires in the group can be changed with input T3 and T4. The following table uses the rotary selector switch position to indicate which group is assigned to the DALI XC.

Commands send out:

- T1 ... short press = DALI Command 0 = OFF
long press = DALI Command 2 = DOWN
- T2 ... short press = DALI Command 5 = Recall max. level
long press = DALI Command 1 = UP
- T3 ... DALI Command 233 = tc step warmer
- T4 ... DALI Command 232 = tc step cooler

Rotary selector switch position	Group
0	all
1	0
2	1
3	2
4	3
5	4
6	5
7	6
8	7
9	8
10	9
11	10
12	11
13	12
14	13
15	14

Table 3: Assigning groups (DALI XC in "TuWh" operating mode)

Assigning scenes to inputs (DALI XC in "SC-A" or "SC" operating mode)

Rotary selector switch position B or C

The **Config** rotary selector switch is used to assign different scenes to inputs T1–T4. The following table uses the rotary selector switch position to indicate which scene is assigned to the inputs.

Rotary selector switch position	Scene			
	Input T1	Input T2	Input T3	Input T4
0	0	1	2	3
1	1	2	3	4
2	2	3	4	5
3	3	4	5	6
4	4	5	6	7
5	5	6	7	8
6	6	7	8	9
7	7	8	9	10
8	8	9	10	11
9	9	10	11	12
10	10	11	12	13
11	11	12	13	14
12	12	13	14	15
13	13	14	15	0
14	14	15	0	1
15	15	0	1	2

Table 4: Assigning scenes to inputs (DALI XC in "SC-A" or "SC" operating mode)

5 Commissioning

Requirement:

- Lighting system must have been fully installed.

A DALI XC in **Prog** operating mode is designed for commissioning a lighting system. However, if all DALI XC devices in the lighting system are already installed and can no longer be accessed, a DALI XC in **GC** operating mode can be used to commission the system. This procedure is useful for cases where the lighting system needs to be re-initialised.



Note

After commissioning, the **Mode** rotary selector switch is used to switch the DALI XC from **Prog** operating mode to another mode so that it can be operated as an input device. The device must be accessible in the concealed box for this to take place. Alternatively, a DALI XC device can be connected to the DALI control line at an accessible point (e.g. the distribution board) for commissioning purposes only.

Commissioning consists of three steps:

1. Start commissioning.
If the DALI XC devices in the lighting system can be accessed, commissioning can be quickly and easily started with a DALI XC in **Prog** operating mode.
If the DALI XC devices in the lighting system can no longer be accessed, commissioning can be started with a DALI XC in **GC** operating mode.
2. Group luminaires.
First select the luminaire to be grouped. This luminaire is then assigned to a group using a momentary-action switch.
3. Finish commissioning.

5.1 Starting commissioning

Starting commissioning with DALI XC in "Prog" operating mode



Note

Existing assignments of luminaires to groups are deleted.

Starting may take several minutes depending on the number of connected luminaires.

1. Hold down momentary-action switch (approx. 10 s).
 - ➔ 2 beeps sound at the beginning.
 - ➔ 3 beeps sound after another 10 s.
2. Release momentary-action switch.
 - ➔ Assignment of all luminaires to groups has been deleted.
 - ➔ Programming mode is enabled.
 - ➔ All luminaires are dimmed to the minimum value.
 - ➔ All luminaires are brightened one after the other.
 - ➔ All luminaires are then dimmed to the minimum value again.
 - ➔ 1 beep sounds.
 - ➔ One luminaire brightens.

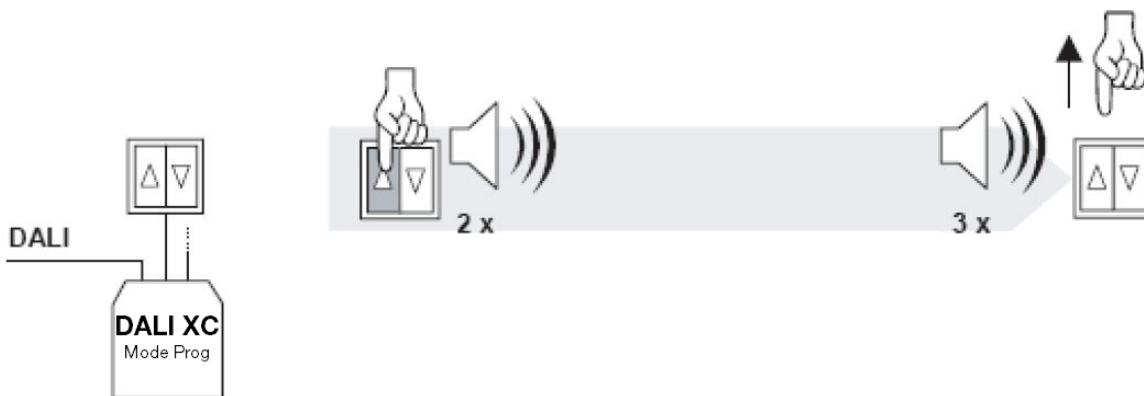

Figure 3: Starting commissioning (DALI XC in "Prog" operating mode)

Starting commissioning with DALI XC in "GC" operating mode



Note

Existing assignments of luminaires to groups are deleted.

Starting may take several minutes depending on the number of connected luminaires.

1. Hold down momentary-action switch (approx. 10 s).
 - ➔ 1 beep sounds.
2. Release momentary-action switch.
 - ➔ 1 beep sounds.
3. Hold down momentary-action switch (approx. 3 s).
 - ➔ 2 beeps sound after 1 s.
 - ➔ 3 beeps sound after another 2 s.
4. Release momentary-action switch.
 - ➔ Assignment of all luminaires to groups has been deleted.
 - ➔ Programming mode is enabled.
 - ➔ All luminaires are dimmed to the minimum value.
 - ➔ All luminaires are brightened one after the other.
 - ➔ All luminaires are then dimmed to the minimum value again.
 - ➔ 1 beep sounds.
 - ➔ One luminaire brightens.

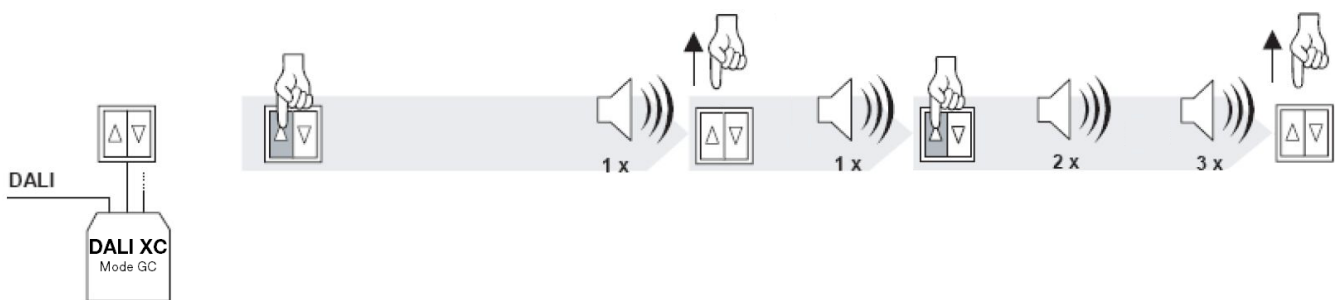

Figure 4: Starting commissioning (DALI XC in "GC" operating mode)

5.2 Grouping luminaires

Requirement:

- Programming mode must have been started.



Note

In programming mode:

The luminaire that is bright is the one that is currently selected. Luminaires can be selected using any momentary-action switch on any DALI XC in operating mode **GC-A** and **GC**. Briefly pressing a momentary-action switch selects luminaires one after the other. When the last luminaire is selected, the first luminaire is selected again in the next step.

The DALI XC beeps once every time a momentary-action switch is pressed.

1. Use a momentary-action switch to select the desired luminaire.

⇒ Luminaire brightens.



Note

From now on, use the momentary-action switch to which the desired group is assigned. Section **Project design** describes how to determine which group is assigned to which input.

[Go to Section "Project design"...](#)⁹

2. Hold down momentary-action switch (approx. 3 s).

⇒ 1 beep sounds.

3. Release momentary-action switch.

⇒ Selected luminaire is assigned to the desired group.



Figure 5: Assigning a luminaire to a group



Note

A luminaire can be assigned to more than one group.

Tunable White luminaires and normal luminaires can be assigned to the same group.

5.3 Finishing commissioning

1. Hold down momentary-action switch (approx. 10 s).
 - ➔ 1 beep sounds after 3 s.
 - ➔ 1 beep sounds after another 3 s.
 - ➔ 3 beeps sound after another 4 s.
2. Release momentary-action switch.
 - ➔ Programming mode is terminated.
 - ➔ System is ready again.



Figure 6: Finishing commissioning



Note

If no momentary-action switches are pressed for 10 minutes in programming mode, this mode is automatically terminated.

6 Saving scenes

Scenes can only be saved with a DALI XC in **SC** operating mode.

Requirement:

– Lighting must be set to the desired values.

i

Note

Section **Operation** describes how to set the lighting using a DALI XC.
[Go to Section "Operation"...](#) ²²

From now on, use the momentary-action switch to which the desired scene is assigned. Section **Project design** describes how to determine which scene is assigned to which input.
[Go to Section "Project design"...](#) ⁹

1. Hold down momentary-action switch (approx. 10 s).
 - ⇒ 1 beep sounds.
 2. Release momentary-action switch.
 - ⇒ 2 beeps sound.
 - ⇒ The current intensities and colour temperature values for all luminaires are saved as a scene.
- or –
2. Hold down the momentary-action switch for longer than 2 s.
 - ⇒ No values are saved for the scene.

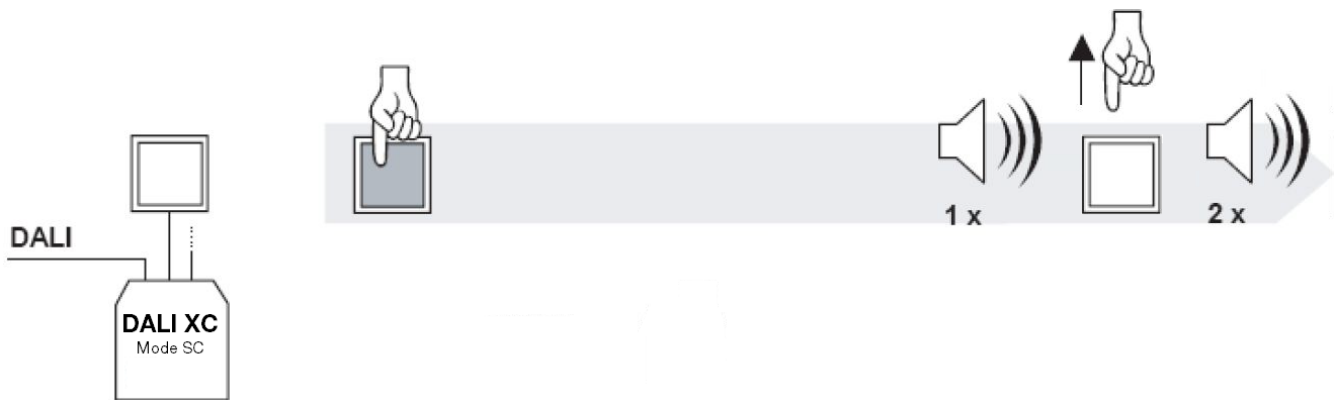

Figure 7: Saving a scene

7 Regrouping luminaires

Grouping can only be carried out with DALI XC devices in **GC-A** or **GC** operating mode.

Regrouping refers to one of two cases:

1. Regroup individual luminaires.

If a luminaire that is already assigned to one group is added to another group, the luminaire is then assigned to both groups. To change the assignment, i.e. move a luminaire from one group to another, the existing assignment must first be deleted and the luminaire must then be reassigned to the desired group. This process is described in this section.

2. Regroup all luminaires (re-initialisation).

If more than one luminaire must be regrouped, it may be more efficient to delete all assignments first and then reassign all luminaires to the desired groups. This process is described in Section **Commissioning**.

[Go to Section "Commissioning"...](#) ¹³

Deleting a luminaire from a group

Requirement:

- System extension must have been started.



Note

Section **Starting system extension** describes how to start the system extension.
[Go to Section "Starting system extension"...](#)²⁵



Note

In programming mode:

The luminaire that is bright is the one that is currently selected. Luminaires can be selected using any momentary-action switch on any DALI XC in operating mode **GC-A** and **GC**. Briefly pressing a momentary-action switch selects luminaires one after the other. When the last luminaire is selected, the first luminaire is selected again in the next step.

The DALI XC beeps once every time a momentary-action switch is pressed.

1. Use a momentary-action switch to select the desired luminaire.

⇒ Luminaire brightens.



Note

From now on, use the momentary-action switch to which the desired group is assigned. Section **Project design** describes how to determine which group is assigned to which input.
[Go to Section "Project design"...](#)⁹

2. Hold down momentary-action switch (approx. 6 s).

⇒ 1 beep sounds after 3 s.

⇒ 1 beep sounds after another 3 s.

3. Release momentary-action switch.

⇒ Selected luminaire is deleted from the desired group.

⇒ Luminaire remains selected.

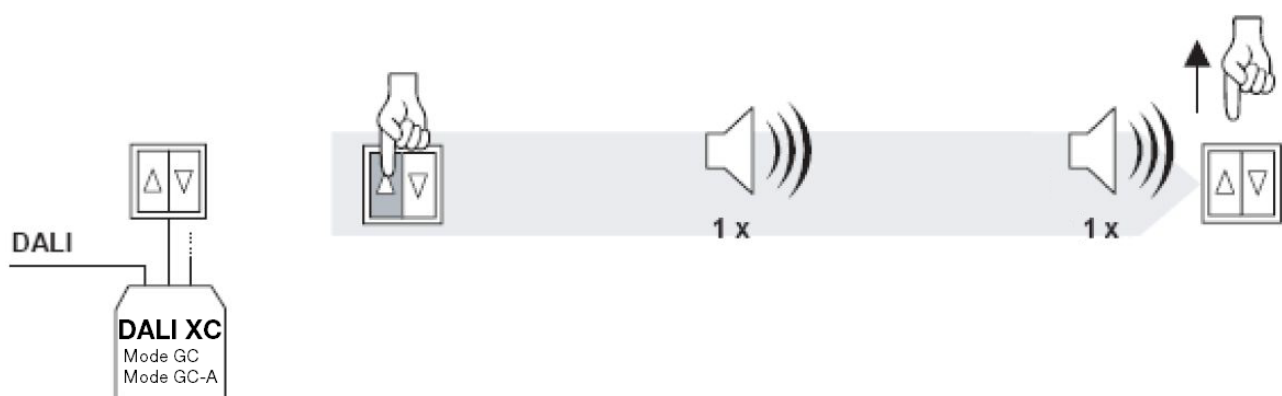

Figure 8: Deleting a luminaire from a group

Grouping luminaire

i

Note

From now on, use the momentary-action switch to which the desired group is assigned. Section **Project design** describes how to determine which group is assigned to which input.
[Go to Section "Project design"...](#)⁹

4. Hold down momentary-action switch (approx. 3 s).
 ➔ 1 beep sounds.
5. Release momentary-action switch.
 ➔ Selected luminaire is assigned to the desired group.



Figure 9: Assigning a luminaire to a group

i

Note

A luminaire can be assigned to more than one group.
 Tunable White luminaires and normal luminaires can be assigned to the same group.

6. Finish system extension.

8 Operation

Depending on which operating mode it is in, the DALI XC can be used to operate luminaires in the following ways:

- Switch luminaire groups on and off
- Brighten and dim luminaire groups
- Increase and decrease the colour temperature of Tunable White luminaires in a luminaire group
- Recall scenes

8.1 Changing intensity

**Note**

The **Config** rotary selector switch is used to assign different groups to the DALI XC inputs. Section **Project design** describes which group is assigned to the inputs. [Go to Section "Project design"...](#)⁹

8.1.1 Single momentary-action switch control

Requirement:

– DALI XC must be in **GC-A** or **GC** operating mode.

Switching lighting on and off

▷ Briefly press single momentary-action switch.

- ↻ The group assigned to the momentary-action switch is switched on and off in alternating sequence each time the momentary-action switch is pressed.

Brightening and dimming lighting

▷ Hold down the single momentary-action switch.

- ↻ The group assigned to the momentary-action switch is brightened and dimmed in alternating sequence each time the momentary-action switch is pressed.

8.1.2 Double momentary-action switch control

Requirement:

- DALI XC must be in **GC-A**, **GC** or **TuWh** operating mode.



Note

If the DALI XC is in **TuWh** operating mode, the intensity of the assigned group can only be changed with the double momentary-action switch connected to input T1 and T2.

Switching on lighting

- ▷ Briefly press double momentary-action switch ↑.
 - ↻ The group assigned to the momentary-action switch is switched on.
 - ↻ The colour temperature of the Tunable White luminaires in the group is set to the last saved value.

Switching off lighting

- ▷ Briefly press double momentary-action switch ↓.
 - ↻ The group assigned to the momentary-action switch is switched off.

Brightening lighting

- ▷ Hold down double momentary-action switch ↑.
 - ↻ The group assigned to the momentary-action switch is brightened.
 - ↻ The colour temperature of the Tunable White luminaires in the assigned group stays the same.

Dimming lighting

- ▷ Hold down double momentary-action switch ↓.
 - ↻ The group assigned to the momentary-action switch is dimmed.
 - ↻ The colour temperature of the Tunable White luminaires in the assigned group stays the same.

8.2 Changing colour temperature



Note

The **Config** rotary selector switch is used to assign different groups to the DALI XC inputs. Section **Project design** describes which group is assigned to the inputs.
[Go to Section "Project design"...](#)⁹

Requirement:

– DALI XC must be in **TuWh** operating mode.



Note

The colour temperature of Tunable White luminaires in the group can only be changed using the double momentary-action switch at input T3 and T4.

A low colour temperature is perceived as warm white light. In contrast a high colour temperature is perceived as cool white light.

Reducing the colour temperature

▷ Hold down double momentary-action switch ↓.

↻ The colour temperature of the Tunable White luminaires in the assigned group is continually decreased.

– or –

▷ Briefly press double momentary-action switch ↓.

↻ The colour temperature of the Tunable White luminaires in the assigned group is decreased by one increment.

Increasing the colour temperature

▷ Hold down double momentary-action switch ↑.

↻ The colour temperature of the Tunable White luminaires in the assigned group is continually increased.

– or –

▷ Briefly press double momentary-action switch ↑.

↻ The colour temperature of the Tunable White luminaires in the assigned group is increased by one increment.

8.3 Recalling scenes



Note

The **Config** rotary selector switch is used to assign different scenes to inputs T1–T4. Section **Project design** describes which scene is assigned to the inputs.
[Go to Section "Project design"...](#)⁹

Requirement:

– DALI XC must be in **SC-A** or **SC** operating mode.

▷ Briefly press single momentary-action switch.

↻ The scene assigned to the momentary-action switch is recalled.

9 System extension

If luminaires or DALI XC devices are added or changed in the lighting system, these devices can be incorporated into the controls using a system extension.

If the DALI XC devices in the lighting system can be easily accessed, the system extension can be quickly and easily started with a DALI XC in **Prog** operating mode.

If the DALI XC devices in the lighting system can no longer be accessed, the system extension can be started with a DALI XC in **GC** operating mode.

9.1 Starting system extension

Starting system extension with DALI XC in "Prog" operating mode

▷ Briefly press momentary-action switch.

- ⇒ 2 beeps sound.
- ⇒ Programming mode is enabled.
- ⇒ All luminaires are dimmed to the minimum value.
- ⇒ All luminaires are brightened one after the other.
- ⇒ All luminaires are then dimmed to the minimum value again.
- ⇒ 1 beep sounds.
- ⇒ One luminaire brightens.

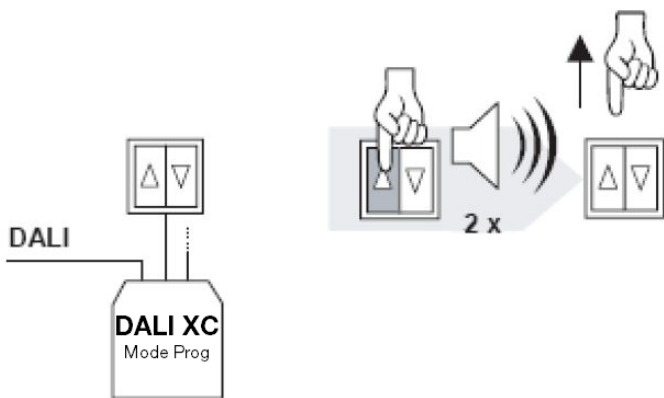

Figure 10: Starting system extension (DALI XC in "Prog" operating mode)

Starting system extension with DALI XC in "GC" operating mode

1. Hold down momentary-action switch (approx. 10 s).
 - ➔ 1 beep sounds.
2. Release momentary-action switch.
 - ➔ 1 beep sounds.
3. Hold down momentary-action switch (approx. 1 s).
 - ➔ 2 beeps sound.
4. Release momentary-action switch.
 - ➔ Programming mode is enabled.
 - ➔ All luminaires are dimmed to the minimum value.
 - ➔ All luminaires are brightened one after the other.
 - ➔ All luminaires are then dimmed to the minimum value again.
 - ➔ 1 beep sounds.
 - ➔ One luminaire brightens.

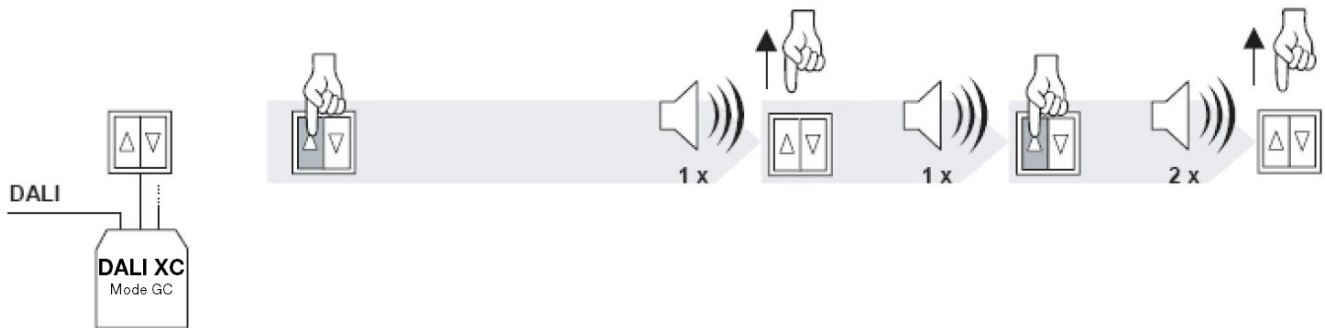

Figure 11: Starting system extension (DALI XC in "GC" operating mode)

9.2 Adding or changing luminaires

1. Disconnect the voltage supply to the lighting system.
2. To change a luminaire, proceed as follows: Remove the old luminaire.
3. Install the new luminaire in accordance with the accompanying installation instructions.
4. Reconnect the voltage supply.
5. Start system extension.
 - ➔ Updated lighting system data is saved to all DALI XC devices.



Note

In programming mode:

The luminaire that is bright is the one that is currently selected. Luminaires can be selected using any momentary-action switch on any DALI XC in operating mode **GC-A** and **GC**. Briefly pressing a momentary-action switch selects luminaires one after the other. When the last luminaire is selected, the first luminaire is selected again in the next step.

The DALI XC beeps once every time a momentary-action switch is pressed.

6. Use a momentary-action switch to select the new luminaire.
 - ➔ Luminaire brightens.



Note

From now on, use the momentary-action switch to which the desired group is assigned. Section **Project design** describes how to determine which group is assigned to which input. [Go to Section "Project design"...](#)⁹

7. Hold down momentary-action switch (approx. 3 s).
 - ➔ 1 beep sounds.
8. Release momentary-action switch.
 - ➔ Selected luminaire is assigned to the desired group.
9. Finish system extension.

Adjusting scenes



Note

Section **Saving scenes** describes how to set and save values for scenes. [Go to Section "Saving scenes"...](#)¹⁸

Carry out the following steps for each scene containing the new luminaire.

1. Recall the scene.
2. Set the values again.
3. Save the scene.

9.3 Adding or changing DALI XC devices

1. Disconnect the voltage supply to the lighting system.
2. To change a DALI XC device, proceed as follows: Remove the old DALI XC.
3. Install the new DALI XC in accordance with the accompanying installation instructions.
4. Set the **Mode** and **Config** rotary selector switch positions to match the old DALI XC or as desired.
5. Reconnect the voltage supply.
6. Start system extension.
 - Luminaire assignment to groups is saved in the new DALI XC device.
 - 1 beep sounds.
 - Luminaire brightens.
7. Finish system extension.

Testing settings



Note

Section **Changing intensity** describes how to change the intensity.
[Go to Section "Changing intensity"...](#) ²²

Section **Changing colour temperature** describes how to change the colour temperature.
[Go to Section "Changing colour temperature"...](#) ²⁴

Section **Recalling scenes** describes how to recall scenes.
[Go to Section "Recalling scenes"...](#) ²⁴

▷ Change the intensity if the device is in **GC-A** or **GC** operating mode.

– or –

▷ Change intensity and colour temperature if the device is in **TuWh** operating mode.

– or –

▷ Recall scenes if the device is in **SC-A** or **SC** operating mode.

Adjusting settings



Note

The user manual for the masterCONFIGURATOR software version 2.10 or higher describes how to configure the **MC** operating mode.

▷ Reprogram functions if the device is in **MC** operating mode.

9.4 Finishing system extension

1. Hold down momentary-action switch (approx. 10 s).
 - ➔ 1 beep sounds after 3 s.
 - ➔ 1 beep sounds after another 3 s.
 - ➔ 3 beeps sound after another 4 s.
2. Release momentary-action switch.
 - ➔ Programming mode is terminated.
 - ➔ System is ready again.

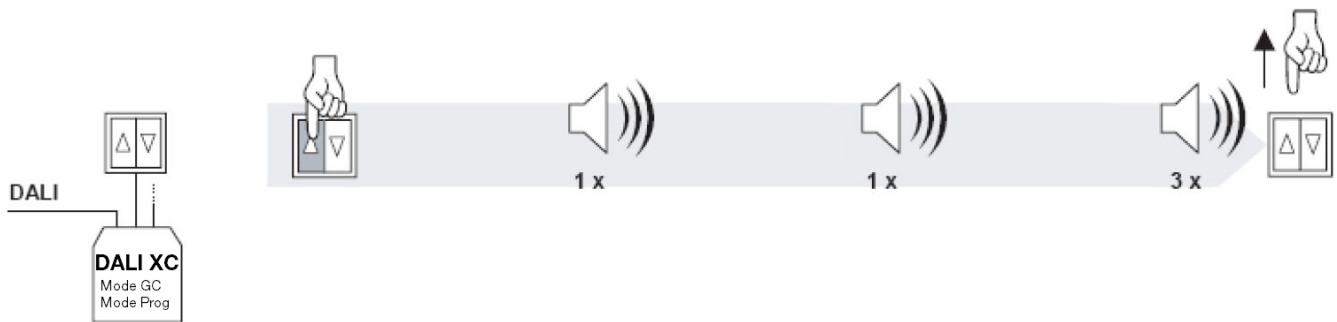

Figure 12: Finishing system extension



Note

If no momentary-action switches are pressed for 10 minutes in programming mode, this mode is automatically terminated.

10 Technical data

Supply	Via DALI control line
Power consumption	Max. 6 mA
Bus loads	Max. 3
Inputs	4 inputs (T1–T4)
Interface	DALI control line (DA, DA)
Terminals	0.5 – 1.5 mm ² (solid or fine-stranded)
Degree of protection	IP20
Housing material	Polycarbonate (PC), flame-retardant, halogen-free
Installation	In concealed box: 60 x 61 (Ø x D, in mm)
Dimensions	47.7 x 28.2 x 14.6 (W x H x D, in mm)
Permissible ambient temperature	0–60°C
Permissible relative humidity	20–90%, non-condensing
Weight	Approx. 12 g

Table 5: DALI XC technical data