

net4more driver DC 30W 350-700mA un:c
LED Driver for net4more systems

Product description

- un:c interface dimmable
- Adjustable output current between 350 and 700 mA
- Output voltage range 20 – 42 V
- Up to 93 % efficiency
- Dimming range 5 – 100 %
- Max. tc point temperature 75 °C
- 5-year guarantee
- net4more articles are part of the net4more toolbox consisting of hardware and software and can be ordered with the system via your local sales team

Housing properties

- Casing: polycarbonate, white
- Type of protection IP20

Interfaces

- un:c – RJ10 (4P4C)
- Terminal blocks: 45° push terminals

Functions

- Adjustable output current
- Protective features (overtemperature, short-circuit, no-load)

Benefits

- Allows integration into IP connected lighting system
- Small dimensions for miniaturization of luminaires
- Application-oriented operating window

Typical applications

- LED Driver for wired and wireless linear/area luminaires in office applications, in combination with dedicated net4more comMOD

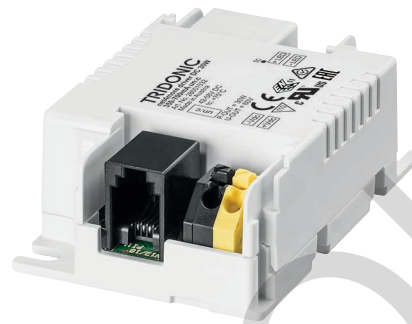

Standards, page 4



net4more driver DC 30W 350-700mA un:c
LED Driver for net4more systems

Technical data

Rated supply voltage DC	46 – 55 V
Input voltage range DC	42 – 58 V
Typ. current (full load) ^① ^③	655 mA
Max. input power ^③	31,5 W
Typ. efficiency (full load) ^① ^②	94 %
Typ. input current in no-load operation	15 mA
Typ. input power in no-load operation	0,75 W
Time to light (full load)	< 0,6 s
Hold on time at power failure	< 5 ms
Output current tolerance ^①	± 3 %
Output current tolerance (at min. dimming level) [±] 10 %	
Max. peak output current	≤ output current + 20 %
Output LF current ripple	same as LF ripple on 48 V supply
Dimming range	5 – 100 %
Max. tc point temperature	75 °C
Dimensions L x W x H	66 x 43 x 22.5 mm

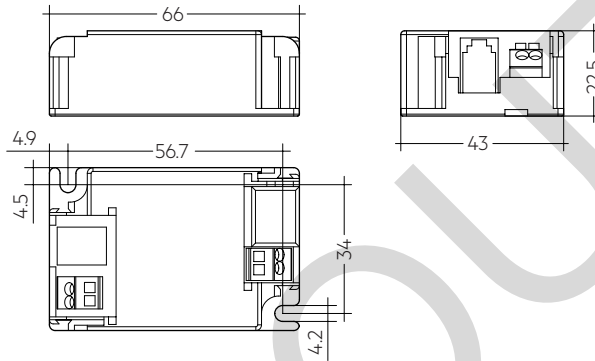

Ordering data

Type	Article number	Packaging carton	Packaging pallet	Weight per pc.
net4more driver DC 30W 350-700mA un:c	28001532	10 pc(s).	2,700 pc(s).	0.035 kg

Specific technical data

Type	Output current	Min. forward voltage	Max. forward voltage	Max. output power (at 48 V, full load)	Typ. power consumption (at 48 V, full load) ^① ^③	Typ. current consumption (at 48 V, full load) ^① ^③
net4more driver DC 30W 350-700mA un:c	350 mA	20 V	42 V	14.7 W	15.8 W	330 mA
	500 mA	20 V	42 V	21.0 W	22.5 W	470 mA
	700 mA	20 V	42 V	29.4 W	31.5 W	655 mA

^① Valid at 100 % dimming level.

^② Depending on the selected output current.

^③ Measurement values without devices at un:c bus.

1. Standards

EN 61347-1
EN 61347-2-13
EN 62384
EN 62386-102
EN 62386-207
UL8750

2. Thermal details and life-time

2.1 Expected life-time

Life-time is limited by DC power supply.
Max. tc point temperature must not be exceeded.

3. Installation / wiring

3.1 Circuit diagram

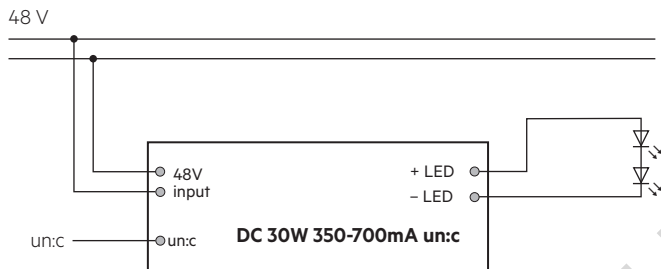

3.2 Wiring type and cross section

The wiring can be in stranded wires with ferrules or solid with a cross section of 0.2–1.5 mm².

Strip 8.5–9.5 mm of insulation from the cables to ensure perfect operation of the push-wire terminals.

Use one wire for each terminal connector only.
Use each strain relief channel for one cable only.

LED module/LED Driver/supply

wire preparation:
0.2 – 1.5 mm²

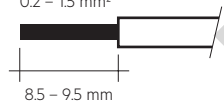

3.3 Loose wiring

Press down the “push button” and remove the cable from front.

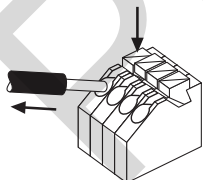

3.4 un:c interface / RJ10

The connection between communication module and LED Driver must be done via a straight through un:c interface cable.

un:c (RJ10)	
pin 1	STR
pin 2	5V
pin 3	GND
pin 4	SCL

3.5 Wiring guidelines

- The cables (48 V and LED module connection cables) should be run separately from other mains cable.
- Mixing of two or more cables from different DC power supplies in the same conduct to light track may interfere.
- The LED wiring should be kept as short as possible.
The max. secondary cable length is 2 m (4 m circuit).
- The LED Driver has no inverse-polarity protection on the secondary side.
Wrong polarity can damage LED modules with no inverse-polarity protection.
- Wrong wiring of the LED Driver can lead to malfunction or irreparable damage.

3.6 LED module hot plug-in

Hot plug-in is not supported due to residual output voltage of > 0 V.
The LED Driver will not be damaged but there is a risk of destroying the LED module.

3.7 48 V power supply

The LED Driver needs to be supplied by a SELV Class 2 power supply with short-circuit protection.

4. Electrical values

4.1 Operating window

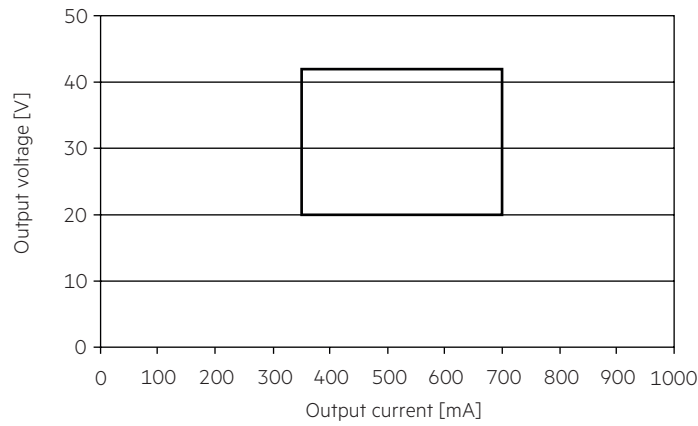

4.2 Efficiency vs load

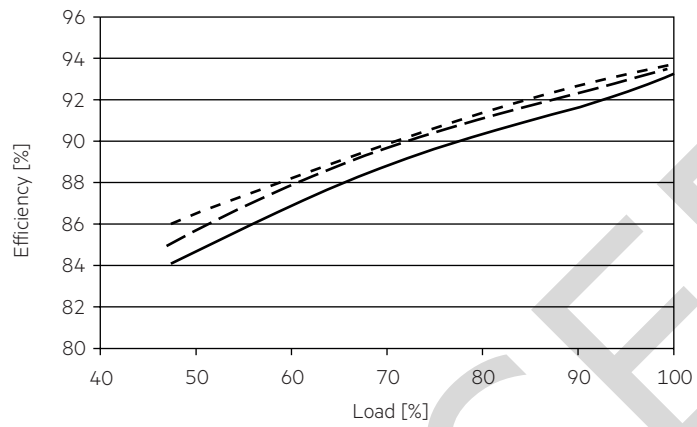

— 350 mA
- - - 500 mA
- · - · 700 mA

100 % load corresponds to the max. output power (full load) according to the table on page 2.

4.3 Dimming

Dimming range 5% to 100%

Digital control via un:c interface.

4.4 Dimming characteristics

Digital dimming value

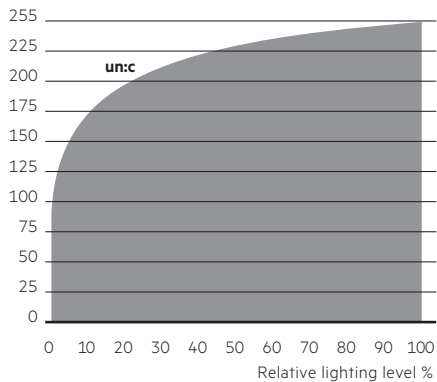

Dimming characteristics as seen by the human eye and is based on the DSI curve.

5. Interfaces / communication

5.1 un:c interface

Parameter	Value
Output voltage	5 V
Min. output voltage	4,2 V
Max. output voltage	5,5 V
Max. output current	400 mA
Max. cable length ^①	15 m
Bus frequency	100 / 400 kHz
Devices per bus	5

① The max. cable length corresponds to the total length of all un:c bus segments.

5.2 Short-circuit behaviour

The LED Driver will not be damaged. In case of a short-circuit at the LED output the LED output is switched off. As soon as the short circuit removed the device has to be restarted via reset of the supply voltage.

5.3 No-load operation

The LED Driver will not be damaged in no-load operation. The output will be deactivated and is therefore free of voltage (after a short period of time). As soon as the LED is connected the device has to be restarted via reset of the supply voltage.

5.4 Overtemperature protection

The LED Driver is protected against temporary thermal overheating. If the temperature limit is exceeded the LED Driver will turn off and after cool down phase automatically restart.

The temperature protection is activated approx. +5 °C above $t_{c\ max}$ (see page 2).

5.5 Overload protection

If the output voltage range is exceeded the LED Driver turns off the LED output. After restart of the DC power supply the LED Driver output will be activated again.

6. Functions

6.1 Adjustable current

The output current of the LED control gear can be adjusted in a certain range.

7. Miscellaneous

7.1 Conditions of use and storage

Humidity: 5% up to max. 85%, not condensed (max. 56 days/year at 85%)

Storage temperature: -40 °C up to max. +80 °C

The LED Drivers have to be acclimatised to the specified temperature range (ta range of DC power supply) before they can be operated.

7.2 Additional information

Additional technical information at www.tridonic.com → Technical Data

Guarantee conditions at www.tridonic.com → Services

Details see Design-In Guide.