



## net4more driver 25W 350-1050mA C unc

LED Driver for net4more systems

### Product description

- Dimmable built-in constant current LED Driver for IP connected luminaires
- Adjustable output current between 350 and 1,050 mA via unc interface
- Max. output power 25 W
- Up to 86 % efficiency
- Dimming range 1 – 100 %
- Life-time up to 100,000 hours
- 5-year guarantee
- net4more articles are part of the net4more toolbox consisting of hardware and software and can be ordered with the system via your local sales team

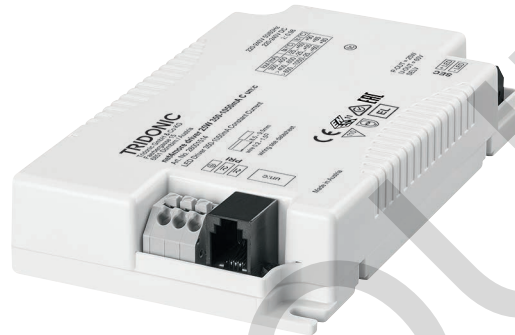

### Housing properties

- Casing: polycarbonate, white
- Type of protection IP20

### Interfaces

- unc – RJ10 (4P4C)
- Terminal blocks: 45° push terminals

### Functions

- Configuration and output current adjustment via unc interface
- Service monitor to log events
- Protective features (overtemperature, short-circuit, overload, no-load, input voltage range, reduced surge amplification)
- Suitable for emergency escape lighting systems acc. to EN 50172

### Benefits

- Allows integration into IP connected lighting system
- Flexible configuration via unc interface
- Application-oriented operating window for maximum compatibility

### Typical applications

- LED Driver for wired and wireless spotlights and downlights in retail and/or office applications



Standards, page 4

IP20 SELV     RoHS

### net4more driver 25W 350-1050mA C unc

LED Driver for net4more systems

#### Technical data

|  |                         |
|--|-------------------------|
| Rated supply voltage   | 220 – 240 V             |
| Input voltage, AC  | 198 – 264 V             |
| Input voltage, DC  | 176 – 280 V             |
| Mains frequency  | 0 / 50 / 60 Hz          |
| Overvoltage protection   | 320 V AC, 48 h          |
| Typ. current (at 230 V, 50 Hz, full load) <sup>① ② ③</sup>               | 99 – 132 mA             |
| Typ. current (220 V, 0 Hz, full load, 15 % dimming level) <sup>② ③</sup> | 24 mA                   |
| Leakage current (at 230 V, 50 Hz, full load) <sup>① ②</sup>              | < 150 µA                |
| Max. input power   | 29.6 W                  |
| Typ. efficiency (at 230 V / 50 Hz / full load) <sup>②</sup>              | 86 %                    |
| λ (at 230 V, 50 Hz, full load) <sup>①</sup>                              | 0.98                    |
| Typ. input current in no-load operation                                  | 1.78 mA                 |
| Typ. input power in no-load operation                                    | 0.45 W                  |
| In-rush current (peak / duration)  | 25 A / 135 µs           |
| THD (at 230 V, 50 Hz, full load) <sup>①</sup>                            | < 10 %                  |
| Time to light (at 230 V, 50 Hz, full load) <sup>①</sup>                  | < 1.12 s                |
| Time to light (DC mode)  | < 0.846 s               |
| Switchover time (AC/DC)  | < 0.4 s                 |
| Turn off time (at 230 V, 50 Hz, full load)                               | < 6.5 ms                |
| Output current tolerance <sup>①</sup>                                    | ± 3 %                   |
| Max. output current peak (non-repetitive)                                | ≤ output current + 40 % |
| Output LF current ripple (< 120 Hz)                                      | ± 2 %                   |
| Max. output voltage (no-load voltage)                                    | 60 V                    |
| Dimming range  | 1 – 100 %               |
| Mains surge capability (between L – N)                                   | 1 kV                    |
| Mains surge capability (between L/N – PE)                                | 2 kV                    |
| Surge voltage at output side (against PE)                                | < 500 V                 |
| Dimensions L x W x H   | 120 x 70 x 22,3 mm      |

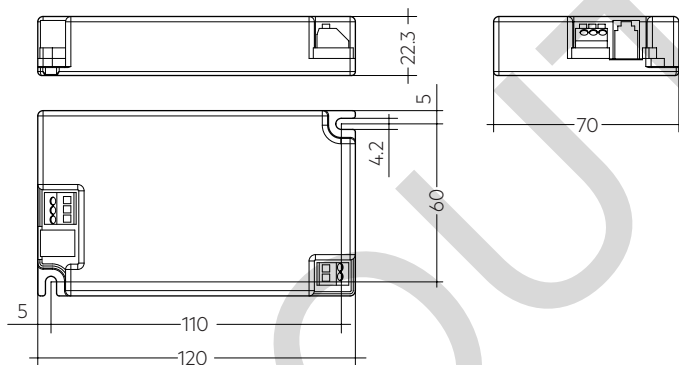

#### Ordering data

| Type                                 | Article number | Packaging carton | Packaging pallet | Weight per pc. |
|--------------------------------------|----------------|------------------|------------------|----------------|
| net4more driver 25W 350-1050mA C unc | 28001514       | 10 pc(s).        | 960 pc(s).       | 0.154 kg       |

#### Specific technical data

| Type                                 | Output current | Min. forward voltage | Max. forward voltage | Max. output power | Typ. power consumption (at 230 V, 50 Hz, full load) <sup>① ③</sup> | Typ. current consumption (at 230 V, 50 Hz, full load) <sup>① ③</sup> | Max. casing temperature tc | Ambient temperature ta max. |
|--------------------------------------|----------------|----------------------|----------------------|-------------------|--|--|----------------------------|-----------------------------|
|                                      | 350 mA         | 20 V                 | 50.0 V               | 17.5 W            | 22.0 W   | 99 mA  | 90 °C                      | -25 ... +60 °C              |
|                                      | 400 mA         | 20 V                 | 50.0 V               | 20.0 W            | 24.5 W   | 110 mA   | 90 °C                      | -25 ... +60 °C              |
|                                      | 450 mA         | 20 V                 | 50.0 V               | 22.5 W            | 27.0 W   | 121 mA   | 85 °C                      | -25 ... +55 °C              |
|                                      | 500 mA         | 20 V                 | 50.0 V               | 25.0 W            | 29.6 W   | 132 mA   | 85 °C                      | -25 ... +55 °C              |
|                                      | 550 mA         | 20 V                 | 45.5 V               | 25.0 W            | 29.2 W   | 130 mA   | 85 °C                      | -25 ... +55 °C              |
|                                      | 600 mA         | 20 V                 | 41.7 V               | 25.0 W            | 29.0 W   | 130 mA   | 85 °C                      | -25 ... +55 °C              |
|                                      | 650 mA         | 20 V                 | 38.5 V               | 25.0 W            | 28.9 W   | 129 mA   | 80 °C                      | -25 ... +60 °C              |
| net4more driver 25W 350-1050mA C unc | 700 mA         | 20 V                 | 35.7 V               | 25.0 W            | 28.9 W   | 129 mA   | 80 °C                      | -25 ... +60 °C              |
|                                      | 750 mA         | 20 V                 | 33.3 V               | 25.0 W            | 28.8 W   | 128 mA   | 80 °C                      | -25 ... +60 °C              |
|                                      | 800 mA         | 20 V                 | 31.3 V               | 25.0 W            | 28.9 W   | 129 mA   | 80 °C                      | -25 ... +60 °C              |
|                                      | 850 mA         | 20 V                 | 29.4 V               | 25.0 W            | 28.9 W   | 129 mA   | 80 °C                      | -25 ... +60 °C              |
|                                      | 900 mA         | 20 V                 | 27.8 V               | 25.0 W            | 29.0 W   | 129 mA   | 80 °C                      | -25 ... +60 °C              |
|                                      | 950 mA         | 20 V                 | 26.3 V               | 25.0 W            | 29.0 W   | 129 mA   | 80 °C                      | -25 ... +60 °C              |
|                                      | 1,000 mA       | 20 V                 | 25.0 V               | 25.0 W            | 29.1 W   | 130 mA   | 80 °C                      | -25 ... +60 °C              |
|                                      | 1,050 mA       | 20 V                 | 23.8 V               | 25.0 W            | 29.2 W   | 130 mA   | 80 °C                      | -25 ... +60 °C              |

① Valid at 100 % dimming level.

② Depending on the selected output current.

③ Measurement values without devices at unc bus.

## 1. Standards

EN 55015  
EN 61000-3-2  
EN 61000-3-3  
EN 61347-1  
EN 61347-2-13  
EN 62384  
EN 61547

According to EN 50172 for use in central battery systems

According to EN 60598-2-22 suitable for emergency lighting installations

## 2. Thermal details and life-time

### 2.1 Expected life-time

| Expected life-time                           |                |           |             |             |          |          |
|--|----------------|-----------|-------------|-------------|----------|----------|
| Type   | Output current | ta        | 40 °C       | 50 °C       | 55 °C    | 60 °C    |
| 350 – 400 mA                                 |                | tc        | 70 °C       | 80 °C       | 85 °C    | 90 °C    |
|  |                | Life-time | > 100,000 h | 95,000 h    | 70,000 h | 50,000 h |
| > 400 – 600 mA                               |                | tc        | 70 °C       | 80 °C       | 85 °C    | –        |
|  |                | Life-time | > 100,000 h | 90,000 h    | 65,000 h | –        |
| <b>net4more driver 25W 350-1050mA C un:c</b> | > 600 – 850 mA | tc        | 60 °C       | 70 °C       | 75 °C    | 80 °C    |
|  |                | Life-time | > 100,000 h | > 100,000 h | 80,000 h | 60,000 h |
| > 850 – 1,050 mA                             |                | tc        | 65 °C       | 70 °C       | 75 °C    | 80 °C    |
|  |                | Life-time | > 100,000 h | 100,000 h   | 70,000 h | 55,000 h |

The LED Driver is designed for a life-time stated above under reference conditions and with a failure probability of less than 10 %.

The relation of tc to ta temperature depends also on the luminaire design.

If the measured tc temperature is approx. 5 K below tc max., ta temperature should be checked and eventually critical components (e.g. ELCAP) measured. Detailed information on request.

## 3. Installation / wiring

### 3.1 Circuit diagram

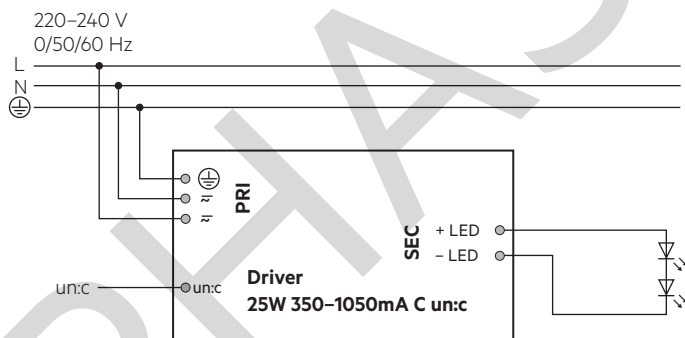

### 3.2 Wiring type and cross section

The wiring can be in stranded wires with ferrules or solid with a cross section of 0.2–1.5 mm<sup>2</sup>.

Strip 8.5–9.5 mm of insulation from the cables to ensure perfect operation of the push-wire terminals.

Use one wire for each terminal connector only.

Use each strain relief channel for one cable only.

LED module/LED Driver/supply

wire preparation:  
0.2 – 1.5 mm<sup>2</sup>

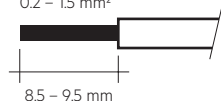

### 3.3 Loose wiring

Press down the "push button" and remove the cable from front.

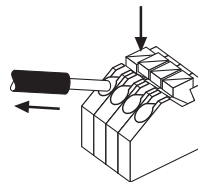

### 3.4 un:c interface / RJ10

The connection between communication module and LED Driver must be done via a straight through un:c interface cable.

| un:c (RJ10) |     |
|-------------|-----|
| pin 1       | STR |
| pin 2       | 5V  |
| pin 3       | GND |
| pin 4       | SCL |

### 3.5 Wiring guidelines

- The cables should be run separately from the mains connections and mains cables to ensure good EMC conditions.
- The LED wiring should be kept as short as possible to ensure good EMC. The max. secondary cable length is 2 m (4 m circuit), this applies for LED output.
- Secondary switching is not permitted.
- The LED Driver has no inverse-polarity protection on the secondary side. Wrong polarity can damage LED modules with no inverse-polarity protection.
- Wrong wiring of the LED Driver can lead to malfunction or irreparable damage.

### 3.6 Hot plug-in

Hot plug-in is not supported due to residual output voltage of > 0 V. If a LED load is connected the device has to be restarted before the output will be activated again. This can be done via mains reset or via interface (un:c).

### 3.7 Earth connection

The earth connection is conducted as protection earth (PE). The LED Driver can be earthed via earth terminal. If the LED Driver will be earthed, protection earth (PE) has to be used. There is no earth connection required for the functionality of the LED Driver. Earth connection is recommended to improve following behaviour:

- Electromagnetic interferences (EMI)
- LED glowing at standby
- Transmission of mains transients to the LED output

In general it is recommended to earth the LED Driver if the LED module is mounted on earthed luminaire parts respectively heat sinks and thereby representing a high capacity against earth.

### 3.8 Installation note

Max. torque at the clamping screw: 0.5 Nm / M4

## 4. Electrical values

### 4.1 Operating window

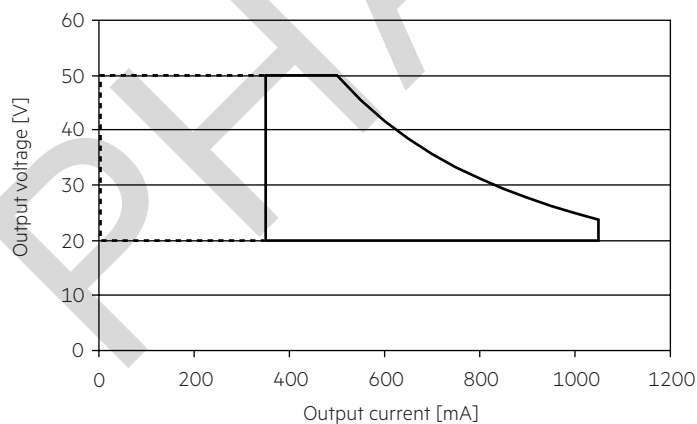

- Operating window 100 %
- - - - - Operating window dimmed

If you run the device outside specification a limitation may be active. This is a technical aspect from the amplitude modulation dimming.

### 4.2 Efficiency vs load

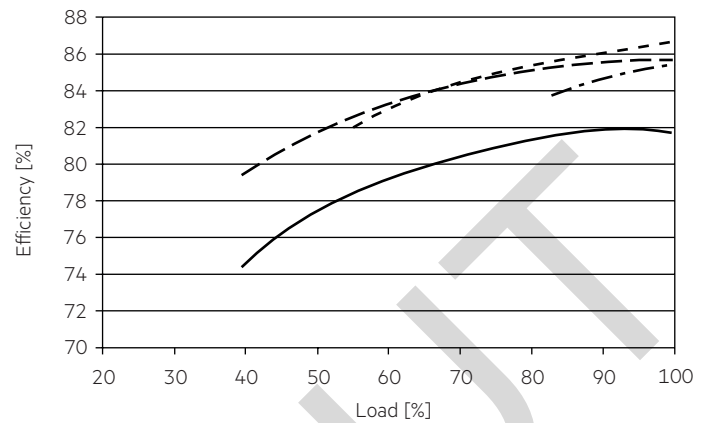

### 4.3 Power factor vs load

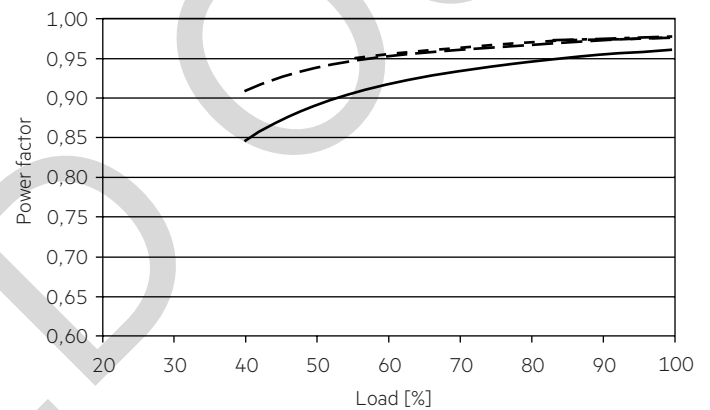

### 4.4 THD vs load

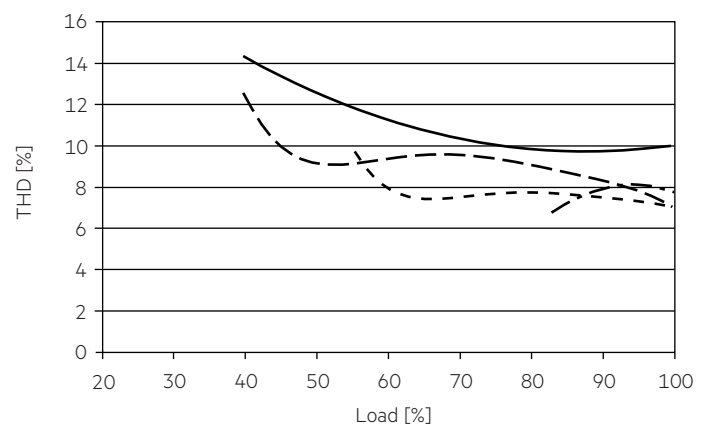

- 350 mA
- - - 500 mA
- · - · 700 mA
- - - - 1050 mA

100 % load corresponds to the max. output power (full load) according to the table on page 2.

#### 4.5 Maximum loading of automatic circuit breakers

| Automatic circuit breaker type               | C10                 | C13                 | C16                 | C20                 | B10                 | B13                 | B16                 | B20                 | Inrush current   |        |
|--|---------------------|---------------------|---------------------|---------------------|---------------------|---------------------|---------------------|---------------------|------------------|--------|
| Installation Ø                               | 1.5 mm <sup>2</sup> | 1.5 mm <sup>2</sup> | 2.5 mm <sup>2</sup> | 2.5 mm <sup>2</sup> | 1.5 mm <sup>2</sup> | 1.5 mm <sup>2</sup> | 2.5 mm <sup>2</sup> | 2.5 mm <sup>2</sup> | I <sub>max</sub> | time   |
| <b>net4more driver 25W 350-1050mA C un:c</b> | 18                  | 26                  | 28                  | 34                  | 9                   | 13                  | 14                  | 17                  | 25 A             | 135 µs |

Calculation uses typical values from ABB series S200 as a reference.  
Actual values may differ due to used circuit breaker types and installation environment.

#### 4.6 Harmonic distortion in the mains supply (at 230 V / 50 Hz and full load) in %

|  | THD | 3.  | 5.  | 7.  | 9.  | 11. |
|--|-----|-----|-----|-----|-----|-----|
| <b>net4more driver 25W 350-1050mA C un:c</b> | < 9 | < 9 | < 3 | < 3 | < 2 | < 1 |

#### 4.7 Dimming

Dimming range 1% to 100 %

Digital control via un:c interface.

#### 4.8 Dimming characteristics

Digital dimming value

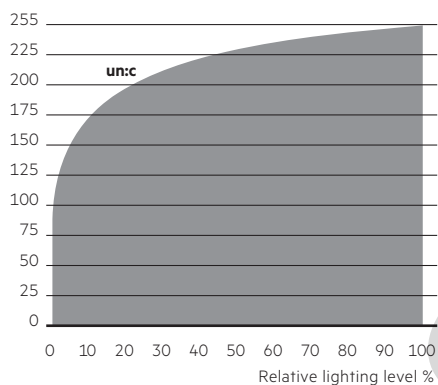

Dimming characteristics as seen by the human eye and is based on the DSI curve.

### 5. Interfaces / communication

#### 5.1 un:c interface

| Parameter                      | Value         |
|--------------------------------|---------------|
| Output voltage                 | 5 V           |
| Min. output voltage            | 4,2 V         |
| Max. output voltage            | 5,5 V         |
| Max. output current            | 400 mA        |
| Max. cable length <sup>①</sup> | 15 m          |
| Bus frequency                  | 100 / 400 kHz |
| Devices per bus                | 10            |

① The max. cable length corresponds to the sum of all lines in un:c interface.

Details see net4more Design-In Guide.

## 6. Functions

### 6.1 Adjustable current

The output current of the LED Driver can be adjusted in a certain range. The adjustment can be made by software via un:c interface.

### 6.2 Short-circuit behaviour

In case of a short-circuit at the LED output the LED output is switched off. After restart of the LED Driver the output will be activated again. The restart can either be done via mains reset or via un:c.

### 6.3 No-load operation

The LED Driver will not be damaged in no-load operation. The output will be deactivated and is therefore free of voltage. If a LED load is connected the device has to be restarted before the output will be activated again.

### 6.4 Overload protection

If the output voltage range is exceeded the LED Driver turns off the LED output. After restart of the LED Driver the output will be activated again. The restart can either be done via mains reset and un:c.

### 6.5 Overtemperature protection

The LED Driver is protected against temporary thermal overheating. If the temperature limit is exceeded the output current of the LED module(s) is reduced. The temperature protection is activated approx. +5 °C above  $t_{c\ max}$  (see page 2). On DC operation this function is deactivated to fulfill emergency requirements.

### 6.6 Power-up fading

The power-up function offers the opportunity to modify the on-behavior. The time for fading on can be adjusted in a range of 0.2 to 16 seconds. According to this value, the device dims either from 0 % up to the power-on level. By factory default no fading time is set (= 0 seconds).

### 6.7 Light level in DC operation

Programmable from 1 – 100 % ( $EOF_i = 0.13$ )  
Programming by un:c interface.  
Default value is 15 %  
In DC operation dimming mode can be activated.

## 7. Miscellaneous

### 7.1 Isolation and electric strength testing of luminaires

Electronic devices can be damaged by high voltage. This has to be considered during the routine testing of the luminaires in production.

According to IEC 60598-1 Annex Q (informative only!) or ENEC 303-Annex A, each luminaire should be submitted to an isolation test with 500 V<sub>DC</sub> for 1 second. This test voltage should be connected between the interconnected phase and neutral terminals and the earth terminal. The isolation resistance must be at least 2M $\Omega$ .

As an alternative, IEC 60598-1 Annex Q describes a test of the electrical strength with 1500 V<sub>AC</sub> (or 1.414 x 1500 V<sub>DC</sub>). To avoid damage to the electronic devices this test must not be conducted.

### 7.2 Conditions of use and storage

Humidity: 5 % up to max. 85 %, not condensed (max. 56 days/year at 85 %)

Storage temperature: -40 °C up to max. +80 °C

The devices have to be acclimatised to the specified temperature range ( $t_a$ ) before they can be operated.

### 7.3 Additional information

Additional technical information at [www.tridonic.com](http://www.tridonic.com) → Technical Data

Guarantee conditions at [www.tridonic.com](http://www.tridonic.com) → Services

Details see Design-In Guide.

Life-time declarations are informative and represent no warranty claim. No warranty if device was opened.