

Module RLE 2x4 / 2x8 2xCH HP HE PRE OTD

Modules RLE excite



RLE 2x4 3000lm 2CH HP HE PRE OTD



RLE 2x8 6000lm 2CH HP HE PRE OTD

Product description

- _ Highly efficient modules for outdoor use perfect in combination with the two-channel
<https://www.tridonic.com/en/int/product/32194?tab=0>
- _ Suitable for harsh and humid outdoor conditions
- _ Tested acc. to salt spray test (IEC 60068-2-52) and harmful gas test (GR-1217-CORE)
- _ Huge performance temperature range from -40 ... +95 °C
- _ Surge tested (+/- to earth) 6 kV with Tridonic LED driver
- _ Zhaga Book 15 certified
- _ For use with standard 2x2 lenses (e.g. LEDiL STRADA 2x2)
- _ Push-in terminals for simple and quick wiring
- _ HE ... High Efficiency, NM ... Nominal Mode, HO ... High Output
- _ Long lifetime up to 100,000 hours
- _ 8 years guarantee (conditions at <https://www.tridonic.com/en/int/services/manufacturer-guarantee-conditions>)

Optical properties

- _ Outdoor Tunable White LED module with 2,200 and 4,000 K LED packages
- _ Efficacy of the LED module up to 207 lm/W
- _ Two colour rendering index to fit the application: CRI > 70 high efficiency, CRI > 80 for high colour rendering
- _ Small luminous flux tolerances ^①

Mechanical properties

- _ Module dimension 49.5 x 121.4 mm and 49.5 x 223 mm
- _ Installation of the module together with lens in the luminaire by means of an M3 screw

System solution

- _ Integrate compatible partner products into your final system solution:
<https://www.tridonic.com/en/int/products/accessories#partner>

^① Integral measurement over the complete module.

Website

<http://www.tridonic.com/28005172>



Linear



High bay



Decorative



Downlights



Spotlights



Free-standing



Area



Floor | Wall



Street

Module RLE 2x4 / 2x8 2xCH HP HE PRE OTD

Modules RLE excite

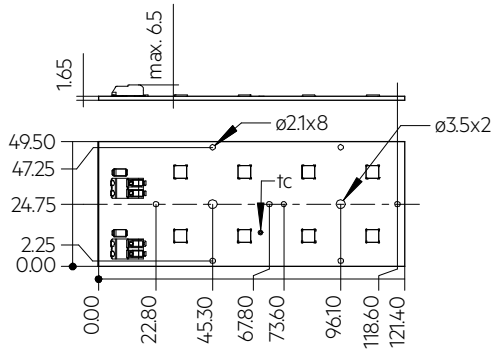

RLE 2x4 3000lm 2CH HP HE PRE OTD

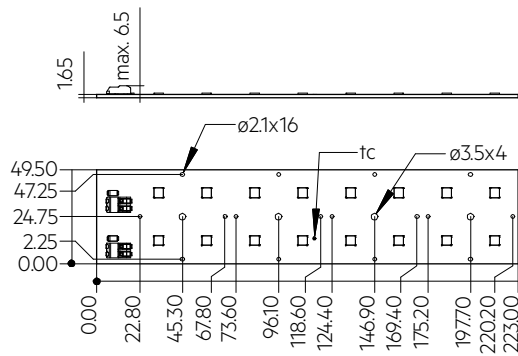

RLE 2x8 6000lm 2CH HP HE PRE OTD

Ordering data

Type	Article number	Colour temperature	Packaging, carton	Weight per pc.
RLE 2x4 3000lm 722-740 2CH HP HE PRE OTD	28005172	2,200 – 4,000 K	80 pc(s).	0.028 kg
RLE 2x4 3000lm 822-840 2CH HP HE PRE OTD	28005173	2,200 – 4,000 K	80 pc(s).	0.028 kg
RLE 2x8 6000lm 722-740 2CH HP HE PRE OTD	28005174	2,200 – 4,000 K	80 pc(s).	0.050 kg
RLE 2x8 6000lm 822-840 2CH HP HE PRE OTD	28005175	2,200 – 4,000 K	80 pc(s).	0.050 kg

Technical data

Beam characteristic	120°
Ambient temperature t_a	-40 ... +80 °C
t_p rated	75 °C
t_c	95 °C
I_{rated}	350 mA
I_{max}	900 mA
Max. permissible LF current ripple	1,000 mA
Max. permissible peak current	1,250 mA / max. 10 ms
Max. working voltage for insulation with lens ²⁾	670 V
Insulation test voltage	2.34 kV
Colour tolerance ¹⁾	3 SDCM
ESD classification	Severity level 4
Risk group (IEC 62471)	RG2 ($E_{thr} = 1050 \text{ lx}$, RG1 at $d \geq 57 \text{ cm}$ (I_{max})), RG1 ($I \leq 332 \text{ mA}$)
Classification acc. to IEC 62031	Built-in
Type of protection	IP00
Lumen maintenance L70B50	100,000 h
Guarantee (conditions at www.tridonic.com)	8 Year(s)

Approval marks**Standards**

IEC 62031, IEC 62778, IEC 62471, IEC 61000-4-2, IEC 60068-2-52, GR-1217-CORE

Specific technical data

Type	Article number	Colour temperature	Photometric code ^②	Useful luminous flux ^④ at tp = 25 °C	Expected luminous flux ^⑤ at tp rated	Typ. forward current	Min. forward voltage at tp rated	Max. forward voltage at tp = 25 °C	Power consumption ^⑥ Pon at tp = 25 °C	Efficacy of the module at tp = 25 °C	Expected efficacy of the module at tp rated	Colour rendering index CRI
Operating mode HE												
RLE 2x4 3000lm 722-740 2CH HP HE PRE OTD	28005172	2,200 K	722/359	-	770 lm	200 mA	21.1 V	23.0 V	-	-	176 lm/W	>70
RLE 2x4 3000lm 722-740 2CH HP HE PRE OTD	28005172	2,700 K	727/359	-	846 lm	200 mA	21.1 V	23.0 V	-	-	193 lm/W	>70
RLE 2x4 3000lm 722-740 2CH HP HE PRE OTD	28005172	3,000 K	730/359	-	859 lm	200 mA	21.1 V	23.0 V	-	-	196 lm/W	>70
RLE 2x4 3000lm 722-740 2CH HP HE PRE OTD	28005172	4,000 K	740/359	-	910 lm	200 mA	21.1 V	23.0 V	-	-	208 lm/W	>70
RLE 2x4 3000lm 822-840 2CH HP HE PRE OTD	28005173	2,200 K	822/359	-	630 lm	200 mA	21.1 V	23.0 V	-	-	144 lm/W	>80
RLE 2x4 3000lm 822-840 2CH HP HE PRE OTD	28005173	2,700 K	827/359	-	733 lm	200 mA	21.1 V	23.0 V	-	-	167 lm/W	>80
RLE 2x4 3000lm 822-840 2CH HP HE PRE OTD	28005173	3,000 K	830/359	-	771 lm	200 mA	21.1 V	23.0 V	-	-	176 lm/W	>80
RLE 2x4 3000lm 822-840 2CH HP HE PRE OTD	28005173	4,000 K	840/359	-	820 lm	200 mA	21.1 V	23.0 V	-	-	187 lm/W	>80
RLE 2x8 6000lm 722-740 2CH HP HE PRE OTD	28005174	2,200 K	722/359	-	1,540 lm	200 mA	42.2 V	46.0 V	-	-	176 lm/W	>70
RLE 2x8 6000lm 722-740 2CH HP HE PRE OTD	28005174	2,700 K	727/359	-	1,813 lm	200 mA	42.2 V	46.0 V	-	-	207 lm/W	>70
RLE 2x8 6000lm 722-740 2CH HP HE PRE OTD	28005174	3,000 K	730/359	-	1,718 lm	200 mA	42.2 V	46.0 V	-	-	196 lm/W	>70
RLE 2x8 6000lm 722-740 2CH HP HE PRE OTD	28005174	4,000 K	740/359	-	1,810 lm	200 mA	42.2 V	46.0 V	-	-	207 lm/W	>70
RLE 2x8 6000lm 822-840 2CH HP HE PRE OTD	28005175	2,200 K	822/359	-	1,300 lm	200 mA	42.2 V	46.0 V	-	-	148 lm/W	>80
RLE 2x8 6000lm 822-840 2CH HP HE PRE OTD	28005175	2,700 K	827/359	-	1,466 lm	200 mA	42.2 V	46.0 V	-	-	167 lm/W	>80
RLE 2x8 6000lm 822-840 2CH HP HE PRE OTD	28005175	3,000 K	830/359	-	1,542 lm	200 mA	42.2 V	46.0 V	-	-	176 lm/W	>80
RLE 2x8 6000lm 822-840 2CH HP HE PRE OTD	28005175	4,000 K	840/359	-	1,640 lm	200 mA	42.2 V	46.0 V	-	-	187 lm/W	>80
Operating mode NM												
RLE 2x4 3000lm 722-740 2CH HP HE PRE OTD	28005172	2,200 K	722/359	1,350 lm	1,300 lm	350 mA	21.9 V	23.8 V	8.1 W	175 lm/W	164 lm/W	>70
RLE 2x4 3000lm 722-740 2CH HP HE PRE OTD	28005172	2,700 K	727/359	-	1,428 lm	350 mA	21.9 V	23.8 V	-	-	180 lm/W	>70
RLE 2x4 3000lm 722-740 2CH HP HE PRE OTD	28005172	3,000 K	730/359	-	1,449 lm	350 mA	21.9 V	23.8 V	-	-	182 lm/W	>70
RLE 2x4 3000lm 722-740 2CH HP HE PRE OTD	28005172	4,000 K	740/359	-	1,530 lm	350 mA	21.9 V	23.8 V	-	-	193 lm/W	>70
RLE 2x4 3000lm 822-840 2CH HP HE PRE OTD	28005173	2,200 K	822/359	1,200 lm	1,070 lm	350 mA	21.9 V	23.8 V	8.1 W	143 lm/W	134 lm/W	>80
RLE 2x4 3000lm 822-840 2CH HP HE PRE OTD	28005173	2,700 K	827/359	-	1,237 lm	350 mA	21.9 V	23.8 V	-	-	156 lm/W	>80
RLE 2x4 3000lm 822-840 2CH HP HE PRE OTD	28005173	3,000 K	830/359	-	1,301 lm	350 mA	21.9 V	23.8 V	-	-	164 lm/W	>80
RLE 2x4 3000lm 822-840 2CH HP HE PRE OTD	28005173	4,000 K	840/359	-	1,340 lm	350 mA	21.9 V	23.8 V	-	-	174 lm/W	>80
RLE 2x8 6000lm 722-740 2CH HP HE PRE OTD	28005174	2,200 K	722/359	2,720 lm	2,600 lm	350 mA	43.9 V	47.7 V	16.1 W	174 lm/W	163 lm/W	>70
RLE 2x8 6000lm 722-740 2CH HP HE PRE OTD	28005174	2,700 K	727/359	-	3,060 lm	350 mA	43.9 V	47.7 V	-	-	192 lm/W	>70
RLE 2x8 6000lm 722-740 2CH HP HE PRE OTD	28005174	3,000 K	730/359	-	2,898 lm	350 mA	43.9 V	47.7 V	-	-	182 lm/W	>70
RLE 2x8 6000lm 722-740 2CH HP HE PRE OTD	28005174	4,000 K	740/359	-	3,060 lm	350 mA	43.9 V	47.7 V	-	-	192 lm/W	>70
RLE 2x8 6000lm 822-840 2CH HP HE PRE OTD	28005175	2,200 K	822/359	2,400 lm	2,200 lm	350 mA	43.9 V	47.7 V	16.1 W	147 lm/W	138 lm/W	>80
RLE 2x8 6000lm 822-840 2CH HP HE PRE OTD	28005175	2,700 K	827/359	-	2,474 lm	350 mA	43.9 V	47.7 V	-	-	156 lm/W	>80
RLE 2x8 6000lm 822-840 2CH HP HE PRE OTD	28005175	3,000 K	830/359	-	2,601 lm	350 mA	43.9 V	47.7 V	-	-	164 lm/W	>80
RLE 2x8 6000lm 822-840 2CH HP HE PRE OTD	28005175	4,000 K	840/359	-	2,760 lm	350 mA	43.9 V	47.7 V	-	-	174 lm/W	>80
Operating mode HO												
RLE 2x4 3000lm 722-740 2CH HP HE PRE OTD	28005172	2,200 K	722/359	-	2,460 lm	700 mA	23.6 V	25.5 V	-	-	144 lm/W	>70
RLE 2x4 3000lm 722-740 2CH HP HE PRE OTD	28005172	2,700 K	727/359	-	2,699 lm	700 mA	23.6 V	25.5 V	-	-	158 lm/W	>70
RLE 2x4 3000lm 722-740 2CH HP HE PRE OTD	28005172	3,000 K	730/359	-	2,739 lm	700 mA	23.6 V	25.5 V	-	-	161 lm/W	>70
RLE 2x4 3000lm 722-740 2CH HP HE PRE OTD	28005172	4,000 K	740/359	-	2,900 lm	700 mA	23.6 V	25.5 V	-	-	170 lm/W	>70
RLE 2x4 3000lm 822-840 2CH HP HE PRE OTD	28005173	2,200 K	822/359	-	2,010 lm	700 mA	23.6 V	25.5 V	-	-	118 lm/W	>80
RLE 2x4 3000lm 822-840 2CH HP HE PRE OTD	28005173	2,700 K	827/359	-	2,338 lm	700 mA	23.6 V	25.5 V	-	-	137 lm/W	>80
RLE 2x4 3000lm 822-840 2CH HP HE PRE OTD	28005173	3,000 K	830/359	-	2,459 lm	700 mA	23.6 V	25.5 V	-	-	144 lm/W	>80
RLE 2x4 3000lm 822-840 2CH HP HE PRE OTD	28005173	4,000 K	840/359	-	2,610 lm	700 mA	23.6 V	25.5 V	-	-	153 lm/W	>80
RLE 2x8 6000lm 722-740 2CH HP HE PRE OTD	28005174	2,200 K	722/359	-	4,910 lm	700 mA	47.2 V	51.0 V	-	-	144 lm/W	>70
RLE 2x8 6000lm 722-740 2CH HP HE PRE OTD	28005174	2,700 K	727/359	-	5,784 lm	700 mA	47.2 V	51.0 V	-	-	170 lm/W	>70
RLE 2x8 6000lm 722-740 2CH HP HE PRE OTD	28005174	3,000 K	730/359	-	5,479 lm	700 mA	47.2 V	51.0 V	-	-	161 lm/W	>70
RLE 2x8 6000lm 722-740 2CH HP HE PRE OTD	28005174	4,000 K	740/359	-	5,780 lm	700 mA	47.2 V	51.0 V	-	-	169 lm/W	>70
RLE 2x8 6000lm 822-840 2CH HP HE PRE OTD	28005175	2,200 K	822/359	-	4,150 lm	700 mA	47.2 V	51.0 V	-	-	122 lm/W	>80
RLE 2x8 6000lm 822-840 2CH HP HE PRE OTD	28005175	2,700 K	827/359	-	4,677 lm	700 mA	47.2 V	51.0 V	-	-	137 lm/W	>80
RLE 2x8 6000lm 822-840 2CH HP HE PRE OTD	28005175	3,000 K	830/359	-	4,917 lm	700 mA	47.2 V	51.0 V	-	-	144 lm/W	>80
RLE 2x8 6000lm 822-840 2CH HP HE PRE OTD	28005175	4,000 K	840/359	-	5,230 lm	700 mA	47.2 V	51.0 V	-	-	153 lm/W	>80

① Integral measurement over the complete module.

② Lens shape like LEDIL Strada 2x2.

③ The detailed explanation, see data sheet section 1.1.

④ Tolerance of useful light flux - 0 % / + 15 %. Measurement uncertainty ± 10 %.

⑤ Measurement uncertainty ± 10 %. Based on calculation.

⑥ Tolerance of power consumption Pon ± 10 %. Measurement uncertainty ± 5 %.

1. Standards

EC 62031
IEC 62778
IEC 62471
IEC 61000-4-2
IEC 60068-2-52
GR-1217-CORE

1.1 Photometric code

Key for photometric code, e. g. 830 / 579

1 st digit	2 nd + 3 rd digit	4 th digit	5 th digit	6 th digit
Code CRI	Colour temperature in Kelvin x 100	MacAdam initial	MacAdam after 25% of the lifetime (max.6000h)	Luminous flux after 25% of the lifetime (max.6000h)
7 70 – 79				Code Luminous flux
8 80 – 89				7 ≥ 70 %
9 ≥90				8 ≥ 80 %
				9 ≥ 90 %

1.2 Risk group

Type	Risk group (IEC 62471)
RLE 2x4 HP HE PRE OTD at $I \leq 332$ mA	RG1
RLE 2x4 HP HE PRE OTD at I_{max}	RG2 (E _{thr} = 1050 lx, RG1 at $d \geq 57$ cm)

Current value per channel.

1.3 Energy classification

Type	Colour temperature	Forward current	Energy classification	Energy consumption
RLE 2x4 3000lm 722-740 2CH HP HE PRE OTD	2,200 K	350 mA	D	9 kWh / 1,000 h
RLE 2x4 3000lm 822-840 2CH HP HE PRE OTD	2,200 K	350 mA	D	9 kWh / 1,000 h
RLE 2x8 6000lm 722-740 2CH HP HE PRE OTD	2,200 K	350 mA	D	17 kWh / 1,000 h
RLE 2x8 6000lm 822-840 2CH HP HE PRE OTD	2,200 K	350 mA	D	17 kWh / 1,000 h

Energy label and further information at www.tridonic.com in the certificates tab of the corresponding product page and at the EPREL data base <https://eprel.ec.europa.eu/>

2. Thermal details

2.1 tc point, ambient temperature and lifetime

The temperature at tp reference point is crucial for the light output and lifetime of a LED product.

For RLE a tp temperature of 75 °C has to be complied in order to achieve an optimum between heat sink requirements, light output and lifetime.

Compliance with the maximum permissible reference temperature at the tc point must be checked under operating conditions in a thermally stable state. The maximum value must be determined under worst-case conditions for the relevant application.

The tc and tp temperature of LED modules from Tridonic are measured at the same reference point.

2.2 Storage and humidity

Storage temperature	-40...+80 °C
---------------------	--------------

Operation only in non condensing environment.

Humidity during processing of the module should be between 30 to 70 %.

2.3 Thermal design and heat sink

The rated life of LED products depends to a large extent on the temperature. If the permissible temperature limits are exceeded, the life of the RLE will be greatly reduced or the RLE may be destroyed.

2.4 Heat sink values

RLE 2x4 3000lm 2CH PRE OTD

ta	tp	Forward current	R _{th, hs-a}	Cooling area
25 °C	75 °C	200 mA	12.19 K/W	55 cm ²
25 °C	75 °C	350 mA	6.64 K/W	100 cm ²
25 °C	75 °C	700 mA	3.03 K/W	220 cm ²
35 °C	75 °C	200 mA	9.75 K/W	68 cm ²
35 °C	75 °C	350 mA	5.31 K/W	126 cm ²
35 °C	75 °C	700 mA	2.42 K/W	276 cm ²
40 °C	75 °C	200 mA	8.53 K/W	78 cm ²
40 °C	75 °C	350 mA	4.64 K/W	144 cm ²
40 °C	75 °C	700 mA	2.12 K/W	315 cm ²
45 °C	75 °C	200 mA	7.31 K/W	91 cm ²
45 °C	75 °C	350 mA	3.98 K/W	168 cm ²
45 °C	75 °C	700 mA	1.81 K/W	368 cm ²
50 °C	75 °C	200 mA	6.09 K/W	110 cm ²
50 °C	75 °C	350 mA	3.31 K/W	201 cm ²
50 °C	75 °C	700 mA	1.51 K/W	442 cm ²
55 °C	75 °C	200 mA	4.87 K/W	137 cm ²
55 °C	75 °C	350 mA	2.65 K/W	252 cm ²
55 °C	75 °C	700 mA	1.20 K/W	554 cm ²
60 °C	75 °C	200 mA	3.65 K/W	183 cm ²
60 °C	75 °C	350 mA	1.98 K/W	336 cm ²
60 °C	75 °C	700 mA	0.90 K/W	740 cm ²

RLE 2x8 6000lm 2CH PRE OTD

ta	tp	Forward current	R _{th, hs-a}	Cooling area
25 °C	75 °C	200 mA	5.57 K/W	120 cm ²
25 °C	75 °C	350 mA	3.04 K/W	219 cm ²
25 °C	75 °C	700 mA	1.40 K/W	476 cm ²
35 °C	75 °C	200 mA	4.45 K/W	150 cm ²
35 °C	75 °C	350 mA	2.43 K/W	274 cm ²
35 °C	75 °C	700 mA	1.12 K/W	596 cm ²
40 °C	75 °C	200 mA	3.89 K/W	171 cm ²
40 °C	75 °C	350 mA	2.13 K/W	313 cm ²
40 °C	75 °C	700 mA	0.98 K/W	682 cm ²
45 °C	75 °C	200 mA	3.34 K/W	200 cm ²
45 °C	75 °C	350 mA	1.82 K/W	366 cm ²
45 °C	75 °C	700 mA	0.84 K/W	797 cm ²
50 °C	75 °C	200 mA	2.78 K/W	240 cm ²
50 °C	75 °C	350 mA	1.52 K/W	440 cm ²
50 °C	75 °C	700 mA	0.69 K/W	959 cm ²
55 °C	75 °C	200 mA	2.22 K/W	300 cm ²
55 °C	75 °C	350 mA	1.21 K/W	550 cm ²
55 °C	75 °C	700 mA	0.55 K/W	1,204 cm ²
60 °C	75 °C	200 mA	1.66 K/W	401 cm ²
60 °C	75 °C	350 mA	0.91 K/W	736 cm ²
60 °C	75 °C	700 mA	0.41 K/W	1,616 cm ²

Notes

The actual cooling surface can differ because of the material, the structural shape, outside influences and the installation situation. Depending on the heat sink a heat conducting paste or heat conducting film might be necessary to keep the specified tp temperature.

3. Installation / wiring**3.1 Electrical supply/choice of LED driver**

RLE modules from Tridonic are not protected against overvoltages, overcurrents, overloads or short-circuit currents. Safe and reliable operation can only be guaranteed in conjunction with a LED driver which complies with the relevant standards. The use of LED driver from Tridonic in combination with RLE modules guarantees the necessary protection for safe and reliable operation.

If a LED driver other than Tridonic is used, it must provide the following protection:

- Short-circuit protection
- Overload protection
- Overtemperature protection



RLE modules must be supplied by a constant current LED driver. Operation with a constant voltage LED driver will lead to an irreversible damage of the module.

The module is designed for serial wiring.

RLE modules can be operated either from SELV LED drivers or from LED drivers with LV output voltage.



RLE modules are basic insulated up to 670 V if mounted with M3 screws and lens (e.g. LEDiL Strada 2x2) against ground and can be mounted directly on earthed metal parts of the luminaire. If the max. output voltage of the LED driver (also against earth) is above 670 V, an additional insulation between LED module and heat sink is required (for example by insulated thermal pads) or by a suitable luminaire construction.

At voltages > 60 V an additional protection against direct touch (test finger) to the light emitting side of the module has to be guaranteed. This is typically achieved by means of a non removable light distributor over the module.

3.2 Integrated protection

The basic protection level consists of protection against reverse polarity.

3.3 Wiring

3.4 Wiring examples

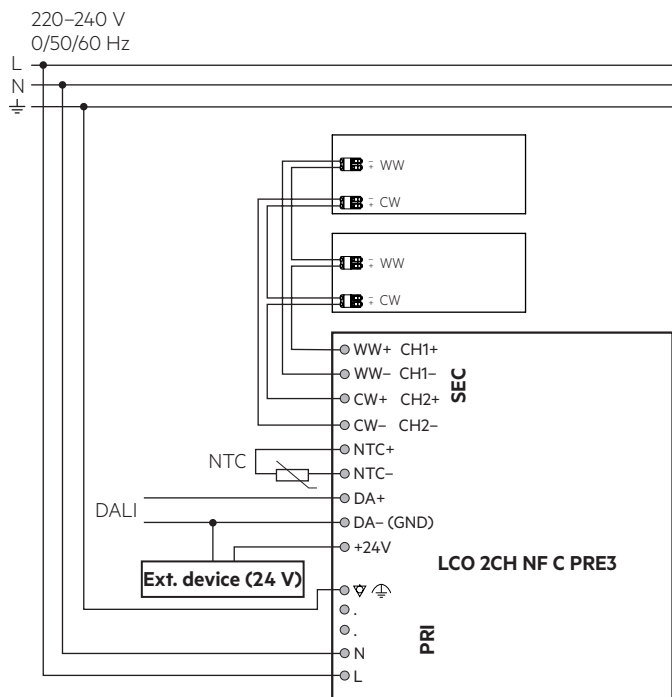

3.5 Wiring type and cross section

For wiring use stranded wire with ferrules or solid wire from 0.2 to 0.75 mm².
For the push-wire connection you have to strip the insulation (7–9 mm).

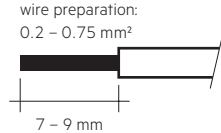

Inserting stranded wires / removing wires by lightly pressing on the push button.

3.6 Mounting instruction



None of the components of the RLE (substrate, LED, electronic components etc.) may be exposed to tensile or compressive stresses.

Max. torque for fixing: 0.5 Nm.

The LED modules are mounted onto a heat sink with M3 screws.



Chemical substance may harm the LED module. Chemical reactions could lead to colour shift, reduced luminous flux or a total failure of the module caused by corrosion of electrical connections.

Materials which are used in LED applications (e.g. sealings, adhesives) must not produce dissolver gas. They must not be condensation curing based, acetate curing based or contain sulfur, chlorine or phthalate.

Avoid corrosive atmosphere during usage and storage.

3.7 EOS/ESD safety guidelines



The device / module contains components that are sensitive to electrostatic discharge and may only be installed in the factory and on site if appropriate EOS/ESD protection measures have been taken. No special measures need be taken for devices/modules with enclosed casings (contact with the pc board not possible), just normal installation practice. Please note the requirements set out in the document EOS / ESD guidelines (Guideline_EOS_ESD.pdf) at: <http://www.tridonic.com/esd-protection>

4. Lifetime

4.1 Lifetime, lumen maintenance and failure rate

The light output of an LED module decreases over the lifetime, this is characterized with the L value.

L70 means that the LED module will give 70 % of its initial luminous flux. This value is always related to the number of operation hours and therefore defines the lifetime of an LED module.

As the L value is a statistical value and the lumen maintenance may vary over the delivered LED modules.

The B value defines the amount of modules which are below the specific L value, e.g. L70B10 means 10 % of the LED modules are below 70 % of the initial luminous flux, respectively 90 % will be above 70 % of the initial value. In addition the percentage of failed modules (fatal failure) is characterized by the C value.

4.2 Lumen maintenance

Typ. forward current	tp tempera- ture	L90 / B10						L90 / B50						L80 / B10						L80 / B50						L70 / B10						L70 / B50					
350 mA	45 °C	>100k h		>100k h		>100k h		>100k h		>100k h		>100k h		>100k h		>100k h		>100k h		>100k h		>100k h		>100k h		>100k h		>100k h									
	55 °C	>100k h		>100k h		>100k h		>100k h		>100k h		>100k h		>100k h		>100k h		>100k h		>100k h		>100k h		>100k h		>100k h		>100k h		>100k h							
	65 °C	>100k h		>100k h		>100k h		>100k h		>100k h		>100k h		>100k h		>100k h		>100k h		>100k h		>100k h		>100k h		>100k h		>100k h		>100k h							
	75 °C	>100k h		>100k h		>100k h		>100k h		>100k h		>100k h		>100k h		>100k h		>100k h		>100k h		>100k h		>100k h		>100k h		>100k h		>100k h							
	85 °C	>100k h		>100k h		>100k h		>100k h		>100k h		>100k h		>100k h		>100k h		>100k h		>100k h		>100k h		>100k h		>100k h		>100k h		>100k h							
	95 °C	>100k h		>100k h		>100k h		>100k h		>100k h		>100k h		>100k h		>100k h		>100k h		>100k h		>100k h		>100k h		>100k h		>100k h		>100k h							
700 mA	45 °C	>100k h		>100k h		>100k h		>100k h		>100k h		>100k h		>100k h		>100k h		>100k h		>100k h		>100k h		>100k h		>100k h		>100k h		>100k h							
	55 °C	>100k h		>100k h		>100k h		>100k h		>100k h		>100k h		>100k h		>100k h		>100k h		>100k h		>100k h		>100k h		>100k h		>100k h		>100k h							
	65 °C	>100k h		>100k h		>100k h		>100k h		>100k h		>100k h		>100k h		>100k h		>100k h		>100k h		>100k h		>100k h		>100k h		>100k h		>100k h							
	75 °C	>100k h		>100k h		>100k h		>100k h		>100k h		>100k h		>100k h		>100k h		>100k h		>100k h		>100k h		>100k h		>100k h		>100k h		>100k h							
	85 °C	>100k h		>100k h		>100k h		>100k h		>100k h		>100k h		>100k h		>100k h		>100k h		>100k h		>100k h		>100k h		>100k h		>100k h		>100k h							
	95 °C	>100k h		>100k h		>100k h		>100k h		>100k h		>100k h		>100k h		>100k h		>100k h		>100k h		>100k h		>100k h		>100k h		>100k h		>100k h							

LOC10 >100k h. At tp rated and Irated, based on 10 switching cycles per day.

4.3 Switching capability

100,000 cycles

Test according to IEC 62717 CI 10.3.3
30 s on / 30 s off at a forward current of 700 mA

5. Electrical values

5.1 Typ. forward voltage vs. forward current

RLE 2x4 3000lm 2CH HP HE PRE OTD

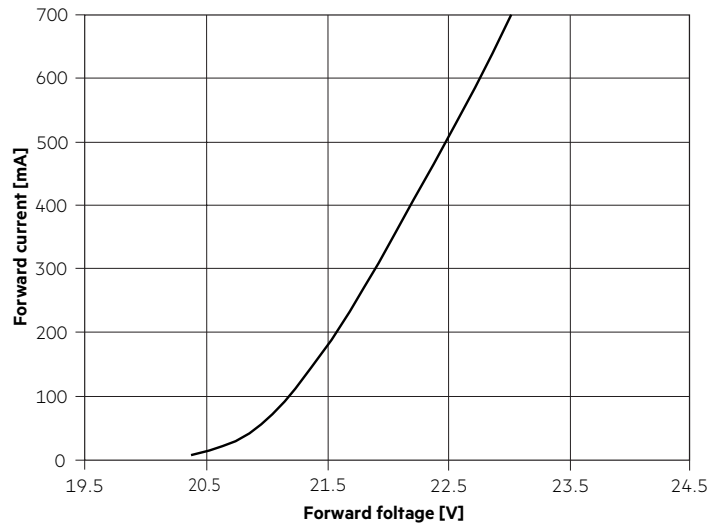

RLE 2x8 6000lm 2CH HP HE PRE OTD

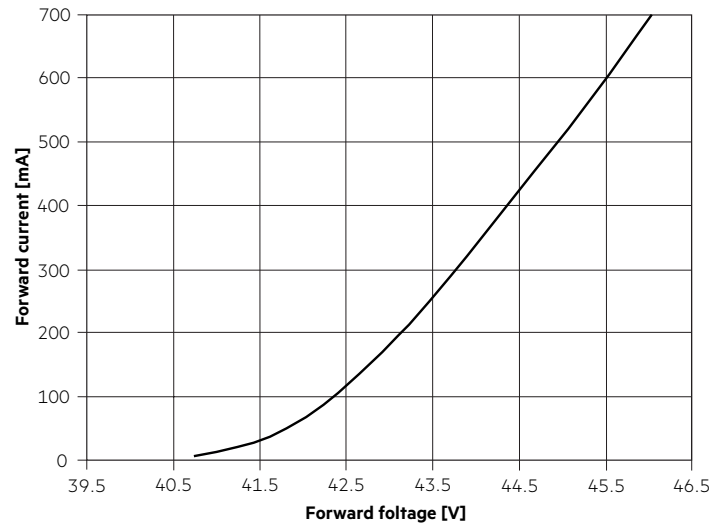

5.2 Forward voltage vs. tc temperature

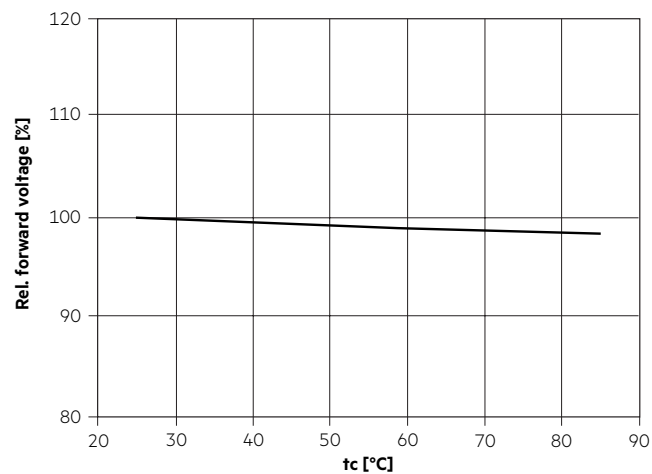

The diagrams are based on statistic values.
The real values can be different.

6. Photometric characteristics

6.1 Coordinates and tolerances according to CIE 1931

The specified colour coordinates are integral measured by current impulse of 640 mA and a duration of < 2 s.
 The ambient temperature of the measurement is 25 °C.
 The measurement tolerance of the colour coordinates are ± 0.01 .

2,200 K, CRI 70

	x0	y0
Centre	0.5019	0.4153

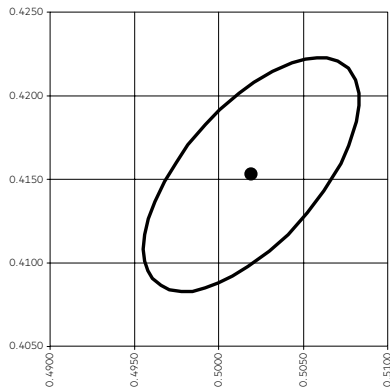

— MacAdam Ellipse: 3SDCM

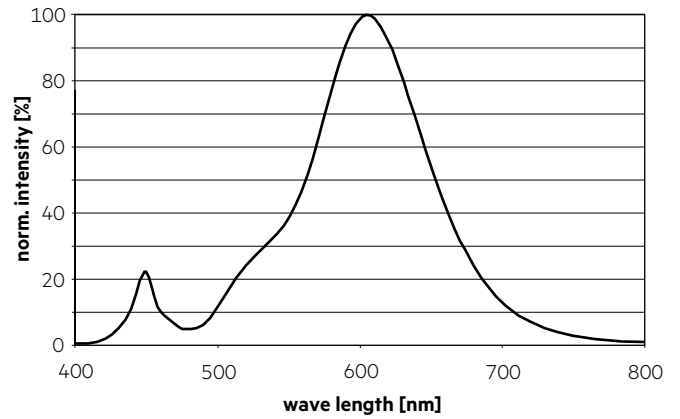

4,000 K, CRI 70

	x0	y0
Centre	0.3818	0.3797

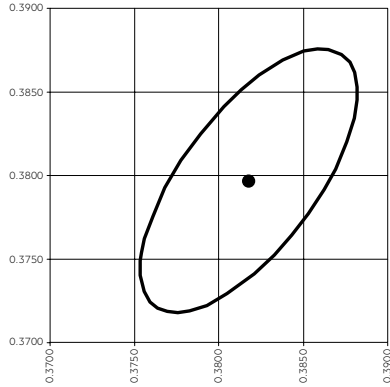

— MacAdam Ellipse: 3SDCM

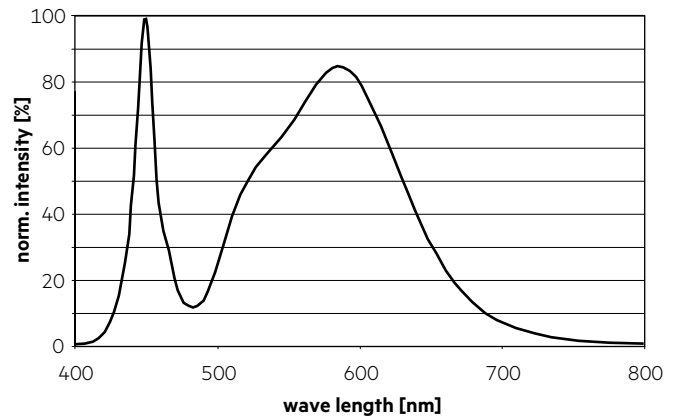

2,200 K, CRI 80

	x0	y0
Centre	0.5019	0.4153

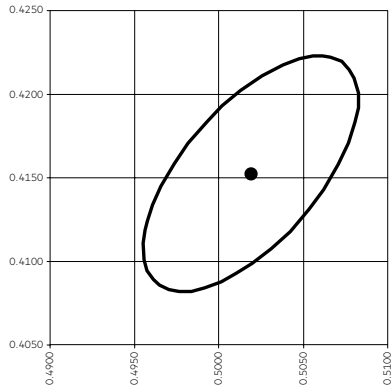

— MacAdam Ellipse: 3SDCM

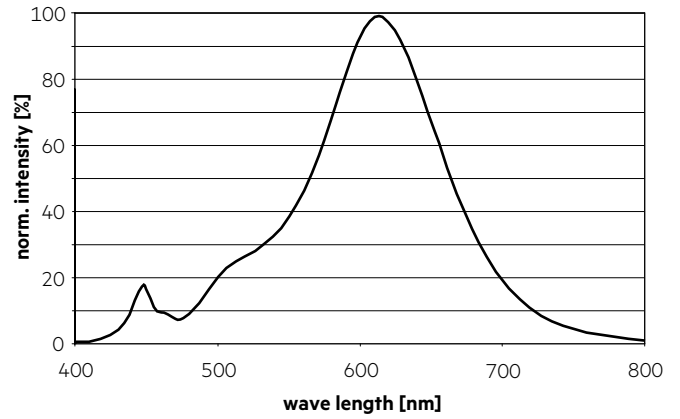

4,000 K, CRI 80

	x0	y0
Centre	0.3818	0.3797

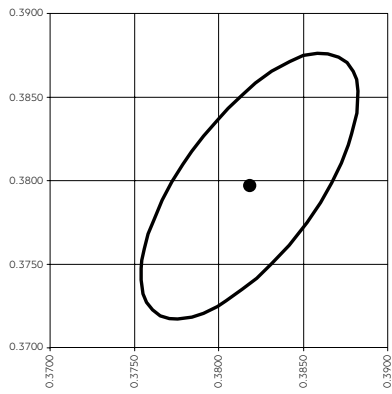

— MacAdam Ellipse: 3SDCM

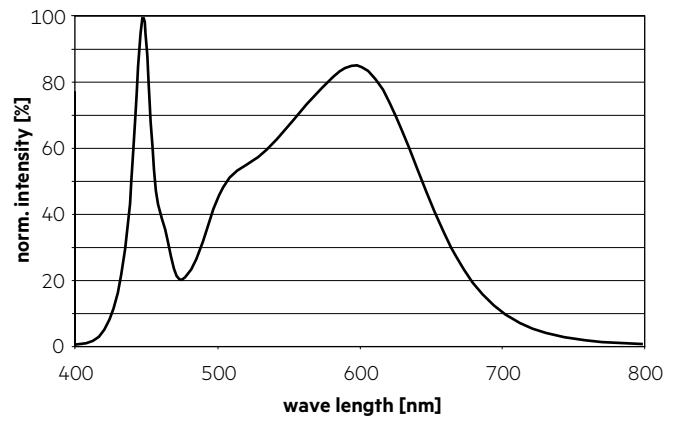

6.2 Spectral G-Index

CCT	CRI	G-Index
2,200 K	70	2.2
4,000 K	70	1.1
2,200 K	80	2.1
4,000 K	80	0.9

Based on typical spectral distribution measured at 25°C and Irated.

6.3 Light distribution

RLE modules are designed to be compatible with 50 x 50 mm lense arrays with 25.4 mm pitch distance. This allows multiple light distributions.

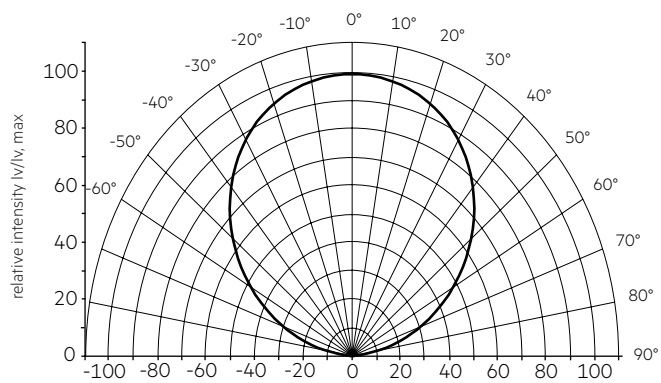

 The colour temperature is measured integral over the complete module. The single LED light points can have deviations in the colour coordinates within MacAdam 4.

6.4 Relative luminous flux vs. tc temperature

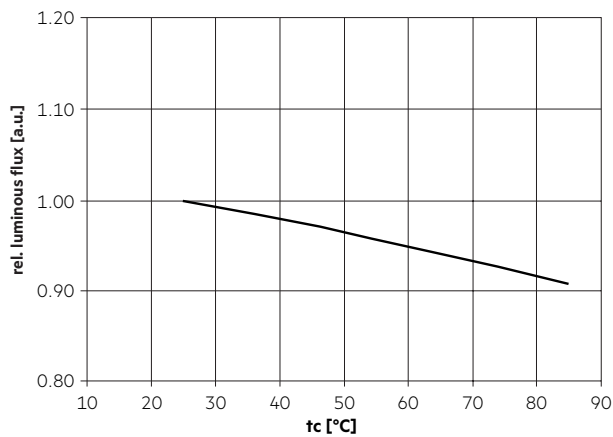

6.5 Relative luminous flux vs. operating current

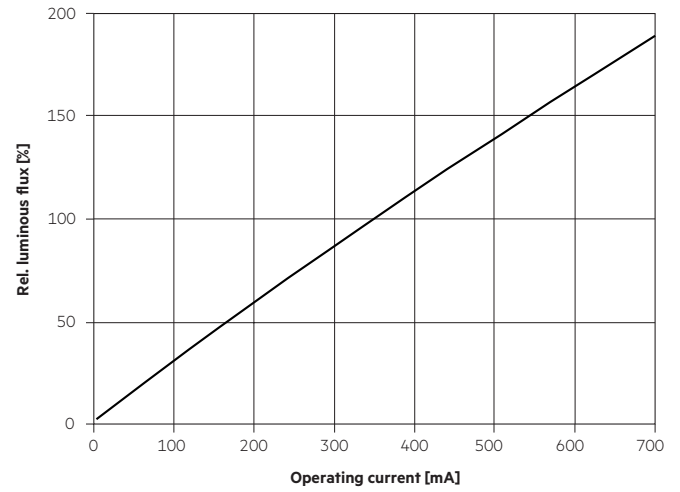

The diagrams are based on statistic values. The real values can be different.

7. Miscellaneous

7.1 Additional information

Additional technical information at www.tridonic.com → Technical Data

Guarantee conditions at www.tridonic.com → Services

Lifetime declarations are informative and represent no warranty claim.