

**Module LLE 24mm 1250lm LV ADV5**

Modules LLE advanced

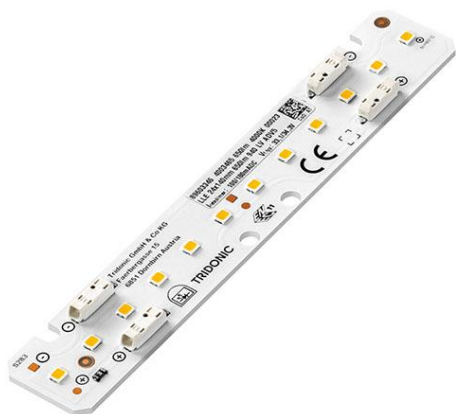

LLE 24x140mm 650lm LV ADV5



LLE 24x280mm 1250lm LV ADV5



LLE 24x560mm 2400lm LV ADV5

**Product description**

- \_ Ideal for linear and panel lights
- \_ 4 terminals for parallel wiring
- \_ Perfectly uniform light, even if several LED modules are used together in a line
- \_ Push terminals for quick and simple wiring of LED module to LED module
- \_ Option backside terminal
- \_ Broad portfolio from extruded lenses and covers available
- \_ HE ... High Efficiency, NM ... Nominal Mode, HO ... High Output
- \_ Long lifetime up to 72,000 hours
- \_ 5 years guarantee (conditions at <https://www.tridonic.com/en/int/services/manufacturer-guarantee-conditions>)

**Optical properties**

- \_ Colour temperatures 2,700, 3,000, 3,500, 4,000 and 6,500 K
- \_ Useful luminous flux 2,507 lm at Irated and tp = 25 °C
- \_ Efficacy of the LED module 190 lm/W at Irated and tp = 25 °C
- \_ High colour rendering index CRI > 80
- \_ High colour consistency (MacAdam 3) <sup>①</sup>
- \_ Small luminous flux tolerances

**Mechanical properties**

- \_ Module dimension 24 x 140 mm, 24 x 280 mm and 24 x 560 mm (ZHAGA compliant)
- \_ Simple installation via clips or screws

**System solution**

- \_ Combine Tridonic's LED modules and dimmable drivers to achieve an outstanding system efficacy (configuration possible via <https://setbuilder.tridonic.com/>)

<sup>①</sup> Integral measurement over the complete module.

**Website**

<http://www.tridonic.com/89603330>

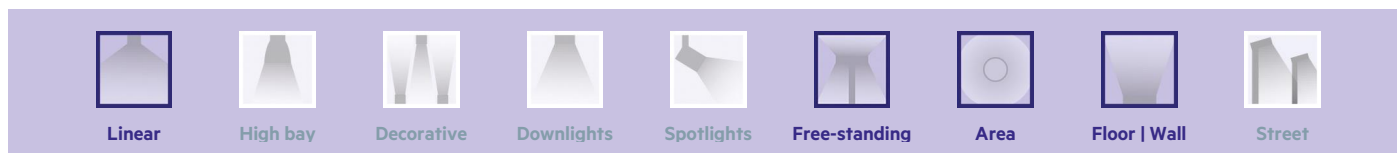
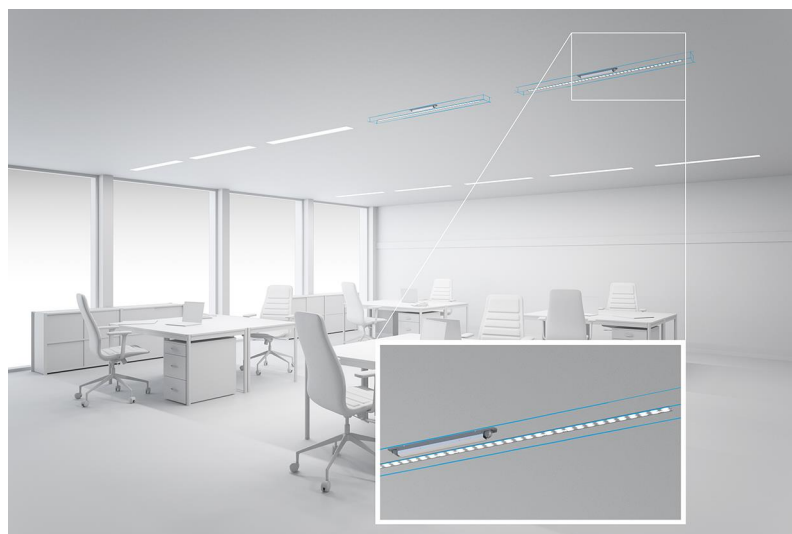

**Module LLE 24mm 1250lm LV ADV5**

Modules LLE advanced

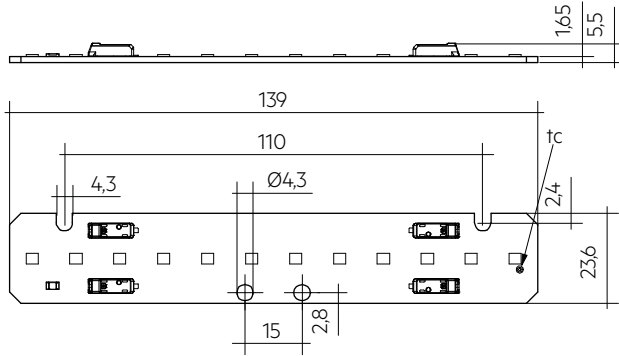

LLE 24x140mm 650lm LV ADV5

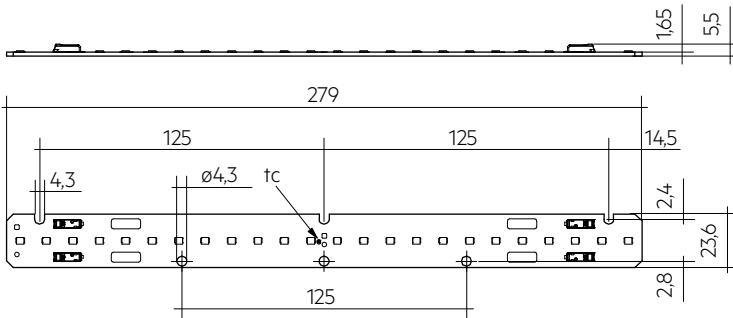

LLE 24x280mm 1250lm LV ADV5

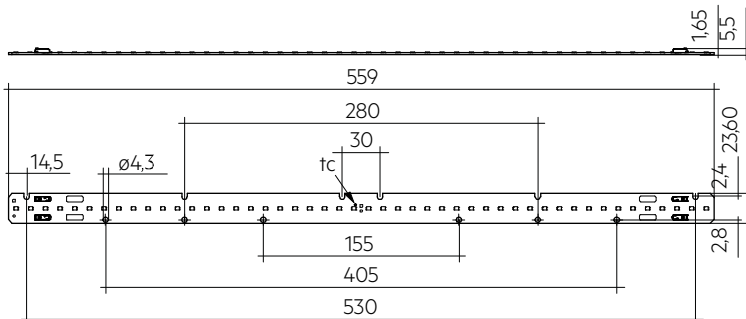

LLE 24x560mm 2400lm LV ADV5

**Ordering data**

Type	Article number	Colour temperature	Packaging, carton	Weight per pc.
<b>Frontside terminal</b>				
LLE 24x140mm 650lm 827 LV ADV5	89603330	2,700 K	108 pc(s).	0.011 kg
LLE 24x280mm 1250lm 827 LV ADV5	89603334	2,700 K	108 pc(s).	0.023 kg
LLE 24x280mm 1250lm 830 LV ADV5	89603335	3,000 K	108 pc(s).	0.023 kg
LLE 24x280mm 1250lm 835 LV ADV5	89603336	3,500 K	108 pc(s).	0.023 kg
LLE 24x280mm 1250lm 840 LV ADV5	89603337	4,000 K	108 pc(s).	0.023 kg
LLE 24x280mm 1250lm 865 LV ADV5	89603446	6,500 K	108 pc(s).	0.023 kg
LLE 24x560mm 2400lm 827 LV ADV5	89603338	2,700 K	108 pc(s).	0.046 kg
LLE 24x560mm 2400lm 830 LV ADV5	89603339	3,000 K	108 pc(s).	0.046 kg
LLE 24x560mm 2400lm 835 LV ADV5	89603340	3,500 K	108 pc(s).	0.046 kg
LLE 24x560mm 2400lm 840 LV ADV5	89603341	4,000 K	108 pc(s).	0.046 kg
<b>Backside terminal</b>				
LLE 24x280mm 1250lm 840 LV ADV5 BT	28003410	4,000 K	240 pc(s).	0.023 kg
LLE 24x560mm 2400lm 840 LV ADV5 BT	89603472	4,000 K	120 pc(s).	0.046 kg

**Technical data**

Beam characteristic	120°
Ambient temperature ta	-40 ... +65 °C
tp rated	50 °C
tc	85 °C
Irated for 650 lm	100 mA
Irated for 1,250 lm	200 mA
Irated for 2,400 lm	400 mA
Imax for 650 lm	180 mA
Imax for 1,250 lm	360 mA
Imax for 2,400 lm	720 mA
Max. permissible LF current ripple for 650 lm	200 mA
Max. permissible LF current ripple for 1,250 lm	400 mA
Max. permissible LF current ripple for 2,400 lm	800 mA
Max. permissible peak current for 650 lm	300 mA / max. 10 ms
Max. permissible peak current for 1,250 lm	600 mA / max. 10 ms
Max. permissible peak current for 2,400 lm	1,200 mA / max. 10 ms
Max. working voltage for insulation SELV ®	60 V
Insulation test voltage	0.5 kV
CTI of the printed circuit board	≥ 600
Colour tolerance	3 SDCM
ESD classification	Severity level 4
Risk group (IEC 62471) for 650lm/ft at ≤ 156 mA	RG0
Risk group (IEC 62471) for 650lm/ft at Imax	RG1
Risk group (IEC 62471) for 1,250lm/ft at ≤ 312 mA	RG0
Risk group (IEC 62471) for 1,250lm/ft at Imax	RG1
Risk group (IEC 62471) for 2,400lm/ft at ≤ 624 mA	RG0
Risk group (IEC 62471) for 2,400lm/ft at Imax	RG1
Classification acc. to IEC 62031	Built-in
Type of protection	IPO0
Lumen maintenance L70B50	72,000 h
Guarantee (conditions at <a href="http://www.tridonic.com">www.tridonic.com</a> )	5 Year(s)

**Approval marks****Standards**

IEC 62031, IEC 62471, IEC 61000-4-2, IEC 62778, IEC 61547, UL 8750

## Specific technical data

Type	Article number	Photometric code	Useful luminous flux at tp = 25 °C <sup>②</sup>	Expected luminous flux at tp rated <sup>③</sup>	Typ. forward current	Min. forward voltage <sup>④</sup> at tp rated	Max. forward voltage <sup>④</sup> at tp = 25 °C	Power consumption Pon at tp = 25 °C <sup>⑤</sup>	Efficacy of the module at tp = 25 °C	Expected efficacy of the module at tp rated	Colour rendering index CRI
<b>Operating mode HE at 150 mA per feet (280 mm module length)</b>											
LLE 24x140mm 650lm 827 LV ADV5	89603330	827/359	-	437 lm	75 mA	31.2 V	33.8 V	-	-	181 lm/W	>80
LLE 24x280mm 1250lm 827 LV ADV5	89603334	827/359	-	879 lm	150 mA	31.2 V	33.8 V	-	-	178 lm/W	>80
LLE 24x280mm 1250lm 830 LV ADV5	89603335	830/359	-	901 lm	150 mA	31.2 V	33.8 V	-	-	185 lm/W	>80
LLE 24x280mm 1250lm 835 LV ADV5	89603336	835/359	-	917 lm	150 mA	31.2 V	33.8 V	-	-	186 lm/W	>80
LLE 24x280mm 1250lm 840 LV ADV5	89603337	840/359	-	948 lm	150 mA	31.2 V	33.8 V	-	-	192 lm/W	>80
LLE 24x280mm 1250lm 865 LV ADV5	89603446	865/359	-	939 lm	150 mA	31.2 V	33.8 V	-	-	190 lm/W	>80
LLE 24x560mm 2400lm 827 LV ADV5	89603338	827/359	-	1,739 lm	300 mA	31.2 V	33.8 V	-	-	179 lm/W	>80
LLE 24x560mm 2400lm 830 LV ADV5	89603339	830/359	-	1,812 lm	300 mA	31.2 V	33.8 V	-	-	186 lm/W	>80
LLE 24x560mm 2400lm 835 LV ADV5	89603340	835/359	-	1,834 lm	300 mA	31.2 V	33.8 V	-	-	188 lm/W	>80
LLE 24x560mm 2400lm 840 LV ADV5	89603341	840/359	-	1,895 lm	300 mA	31.2 V	33.8 V	-	-	193 lm/W	>80
LLE 24x280mm 1250lm 840 LV ADV5 BT	28003410	840/359	-	948 lm	150 mA	31.2 V	33.8 V	-	-	192 lm/W	>80
LLE 24x560mm 2400lm 840 LV ADV5 BT	89603472	840/359	-	1,895 lm	300 mA	31.2 V	33.8 V	-	-	193 lm/W	>80
<b>Operating mode NM at 200 mA per feet (280 mm module length)</b>											
LLE 24x140mm 650lm 827 LV ADV5	89603330	827/359	581 lm	566 lm	100 mA	31.6 V	34.2 V	3.3 W	176 lm/W	173 lm/W	>80
LLE 24x280mm 1250lm 827 LV ADV5	89603334	827/359	1,162 lm	1,132 lm	200 mA	31.6 V	34.2 V	6.7 W	173 lm/W	170 lm/W	>80
LLE 24x280mm 1250lm 830 LV ADV5	89603335	830/359	1,198 lm	1,169 lm	200 mA	31.6 V	34.2 V	6.7 W	179 lm/W	176 lm/W	>80
LLE 24x280mm 1250lm 835 LV ADV5	89603336	835/359	1,216 lm	1,187 lm	200 mA	31.6 V	34.2 V	6.7 W	181 lm/W	179 lm/W	>80
LLE 24x280mm 1250lm 840 LV ADV5	89603337	840/359	1,254 lm	1,225 lm	200 mA	31.6 V	34.2 V	6.7 W	187 lm/W	183 lm/W	>80
LLE 24x280mm 1250lm 865 LV ADV5	89603446	865/359	1,243 lm	1,210 lm	200 mA	31.6 V	34.2 V	6.7 W	186 lm/W	181 lm/W	>80
LLE 24x560mm 2400lm 827 LV ADV5	89603338	827/359	2,309 lm	2,250 lm	400 mA	31.6 V	34.2 V	13.3 W	174 lm/W	171 lm/W	>80
LLE 24x560mm 2400lm 830 LV ADV5	89603339	830/359	2,396 lm	2,328 lm	400 mA	31.6 V	34.2 V	13.3 W	180 lm/W	177 lm/W	>80
LLE 24x560mm 2400lm 835 LV ADV5	89603340	835/359	2,432 lm	2,363 lm	400 mA	31.6 V	34.2 V	13.3 W	183 lm/W	180 lm/W	>80
LLE 24x560mm 2400lm 840 LV ADV5	89603341	840/359	2,507 lm	2,439 lm	400 mA	31.6 V	34.2 V	13.3 W	188 lm/W	185 lm/W	>80
LLE 24x280mm 1250lm 840 LV ADV5 BT	28003410	840/359	1,254 lm	1,225 lm	200 mA	31.6 V	34.2 V	6.7 W	187 lm/W	183 lm/W	>80
LLE 24x560mm 2400lm 840 LV ADV5 BT	89603472	840/359	2,507 lm	2,439 lm	400 mA	31.6 V	34.2 V	13.3 W	188 lm/W	185 lm/W	>80
<b>Operating mode HO at 330 mA per feet (280 mm module length)</b>											
LLE 24x140mm 650lm 827 LV ADV5	89603330	827/359	-	909 lm	165 mA	32.7 V	35.3 V	-	-	162 lm/W	>80
LLE 24x280mm 1250lm 827 LV ADV5	89603334	827/359	-	1,817 lm	330 mA	32.7 V	35.3 V	-	-	160 lm/W	>80
LLE 24x280mm 1250lm 830 LV ADV5	89603335	830/359	-	1,860 lm	330 mA	32.7 V	35.3 V	-	-	165 lm/W	>80
LLE 24x280mm 1250lm 835 LV ADV5	89603336	835/359	-	1,893 lm	330 mA	32.7 V	35.3 V	-	-	167 lm/W	>80
LLE 24x280mm 1250lm 840 LV ADV5	89603337	840/359	-	1,954 lm	330 mA	32.7 V	35.3 V	-	-	173 lm/W	>80
LLE 24x280mm 1250lm 865 LV ADV5	89603446	865/359	-	1,935 lm	330 mA	32.7 V	35.3 V	-	-	171 lm/W	>80
LLE 24x560mm 2400lm 827 LV ADV5	89603338	827/359	-	3,586 lm	660 mA	32.7 V	35.3 V	-	-	160 lm/W	>80
LLE 24x560mm 2400lm 830 LV ADV5	89603339	830/359	-	3,721 lm	660 mA	32.7 V	35.3 V	-	-	166 lm/W	>80
LLE 24x560mm 2400lm 835 LV ADV5	89603340	835/359	-	3,785 lm	660 mA	32.7 V	35.3 V	-	-	168 lm/W	>80
LLE 24x560mm 2400lm 840 LV ADV5	89603341	840/359	-	3,906 lm	660 mA	32.7 V	35.3 V	-	-	174 lm/W	>80
LLE 24x280mm 1250lm 840 LV ADV5 BT	28003410	840/359	-	1,954 lm	330 mA	32.7 V	35.3 V	-	-	173 lm/W	>80
LLE 24x560mm 2400lm 840 LV ADV5 BT	89603472	840/359	-	3,906 lm	660 mA	32.7 V	35.3 V	-	-	174 lm/W	>80

② If mounted with M4 screws and plastic washers.

③ Tolerance of useful light flux - 0 % / + 15 %. Measurement uncertainty ± 10 %.

④ Tolerance of expected light flux - 0 % / + 15 %. Measurement uncertainty ± 10 %. Based on calculation.

⑤ Measurement tolerance forward voltage: ±0.1 V.

⑥ Tolerance of power consumption Pon ± 10 %. Measurement uncertainty ± 5 %.

## LINEAR COVER LLE

Accessory

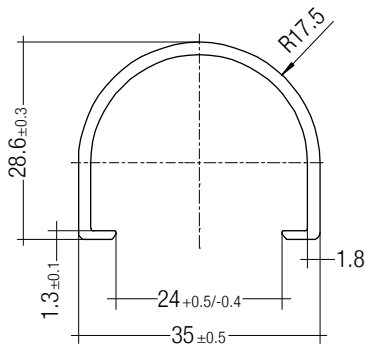

## Product description

- \_ LINEAR COVER for LLE
- \_ Protection against direct touch for non-SELV applications (recommendation LLE 20: use all fixing points and screwed Endcap, recommendation LLE 24: use all fixing points)
- \_ Fast snap on mounting on to LLE 20: with M4 screws and plastic washers, to LLE 24: with clips or plastic washers
- \_ High transmission: transparent, semi-transparent and diffuse
- \_ Material: PMMA
- \_ Tolerances:  $\pm 1$  mm for 597 mm length (ends finished), + 10 mm from length 1,150 mm (ends raw)

## Website

<http://www.tridonic.com/28000338>



## Ordering data

Type	Article number	Colour	Length L	Efficiency	Packaging, carton	Weight per pc.
LINEAR COVER SY Transparent 1600mm	28000338	Transparent	1,600 mm	94 %	12 pc(s).	0.272 kg
LINEAR COVER SY Frosted 1800mm	28000437	Semi-transparent	1,800 mm	87 %	12 pc(s).	0.308 kg
LINEAR COVER SY Frosted 1600mm	28000339	Semi-transparent	1,600 mm	87 %	12 pc(s).	0.272 kg
LINEAR COVER SY Frosted 1500mm	28000435	Semi-transparent	1,500 mm	87 %	12 pc(s).	0.244 kg
LINEAR COVER SY Frosted 1200mm	28000422	Semi-transparent	1,200 mm	87 %	12 pc(s).	0.205 kg
LINEAR COVER SY Frosted 597mm	28000340	Semi-transparent	597 mm	87 %	12 pc(s).	0.102 kg
LINEAR COVER SY Diffuse 1800mm	28000438	Diffuse	1,800 mm	76 %	12 pc(s).	0.308 kg
LINEAR COVER SY Diffuse 1600mm	28000341	Diffuse	1,600 mm	76 %	12 pc(s).	0.272 kg
LINEAR COVER SY Diffuse 1500mm	28000436	Diffuse	1,500 mm	76 %	12 pc(s).	0.257 kg
LINEAR COVER SY Diffuse 1200mm	28000434	Diffuse	1,200 mm	76 %	12 pc(s).	0.205 kg
LINEAR COVER SY Diffuse 597mm	28000342	Diffuse	597 mm	76 %	12 pc(s).	0.102 kg

## ACL ENDCAP LLE

Accessory

**Product description**

- \_ ENDCAP for LLE
- \_ PUSH-FIX: Fast snap on mounting (sheet thickness 0.5 – 1.0 mm), for drilling hole 4 mm
- \_ SCREW-FIX: Screw mounting with EJOT Delta PT WN 5451 30x8 (not included), tightening torque 0.7 Nm
- \_ Clip made of polycarbonate

**Website**

<http://www.tridonic.com/28001037>

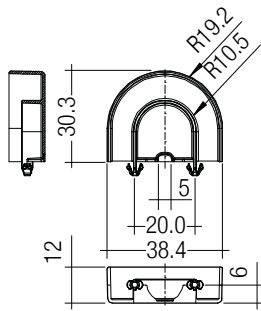
**Ordering data**

Type	Article number	Colour	Packaging, carton	Weight per pc.
ACL ENDCAP LLE24 PUSH-FIX	28001037	White	480 pc(s).	0.003 kg
ACL ENDCAP LLE24 SCREW-FIX	28002315	White	480 pc(s).	0.003 kg

## ACL LINEAR LENS 24mm

Accessory

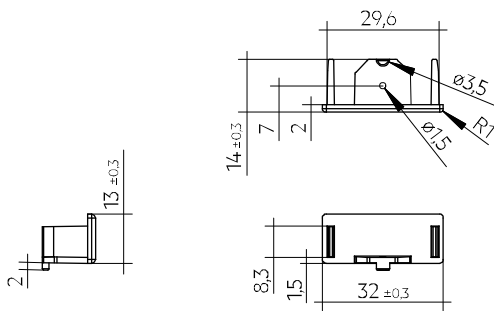
**Product description LINEAR LENS**

- \_ Linear lens for LLE 20 / 24
- \_ Available with different beam characteristics
- \_ Protection against direct touch for non-SELV applications (recommendation: use all fixing points)
- \_ Fast snap on mounting on to LLE 20: with M4 screws and plastic washers, to LLE 24: with clips or plastic washers
- \_ Recommendation: Fastening with screws and plastic washers, see 2.3 Heat sink specifications in data sheet
- \_ Material: PMMA
- \_ Available lengths: 1,200, 1,500 and 1,800 mm, Tolerance: + 10 mm (ends raw)
- \_ Max. permissible temperature 80 °C
- \_ Photometric data available on website

**Product description Endcap**

- \_ ENDCAP for LINEAR LENS 24mm INTENSE, ASY and DASY
- \_ Mounting by clipping in and screwing from below using screw EJOT Delta PT WN 5451 20x4, tightening torque 0.7 Nm
- \_ Made of Polyamide UL94 V0

**Website**

<http://www.tridonic.com/28001428>

**Ordering data**

Type	Article number	Length L	Beam characteristic	Efficiency	Packaging, carton	Weight per pc.
ACL LINEAR LENS 24x1200mm 60°	28001428	1,200 mm	60°	97 %	21 pc(s).	0.196 kg
ACL LINEAR LENS 24x1200mm 90°	28001429	1,200 mm	90°	97 %	21 pc(s).	0.165 kg
ACL LINEAR LENS 24x1500mm 60°	28000953	1,500 mm	60°	97 %	21 pc(s).	0.261 kg
ACL LINEAR LENS 24x1500mm 90°	28000955	1,500 mm	90°	97 %	21 pc(s).	0.221 kg
ACL LINEAR LENS 24x1200mm INTENSE	28002024	1,200 mm	40°	95 %	18 pc(s).	0.261 kg
ACL LINEAR LENS 24x1500mm INTENSE	28002025	1,500 mm	40°	95 %	18 pc(s).	0.326 kg
ACL LINEAR LENS 24x1800mm INTENSE	28002026	1,800 mm	40°	95 %	18 pc(s).	0.392 kg
ACL LINEAR LENS 24x1200mm BATWING	28002027	1,200 mm	batwing	95 %	18 pc(s).	0.275 kg
ACL LINEAR LENS 24x1500mm BATWING	28002028	1,500 mm	batwing	95 %	18 pc(s).	0.344 kg
ACL LINEAR LENS 24x1800mm BATWING	28002029	1,800 mm	batwing	95 %	18 pc(s).	0.412 kg
ACL LINEAR LENS 24x1200mm ASY	28002030	1,200 mm	asymmetric	95 %	18 pc(s).	0.250 kg
ACL LINEAR LENS 24x1500mm ASY	28002031	1,500 mm	asymmetric	95 %	18 pc(s).	0.312 kg
ACL LINEAR LENS 24x1800mm ASY	28002032	1,800 mm	asymmetric	95 %	18 pc(s).	0.375 kg
ACL LINEAR LENS 24x1200mm DASY	28002033	1,200 mm	double asymmetric	92 %	18 pc(s).	0.249 kg
ACL LINEAR LENS 24x1500mm DASY	28002034	1,500 mm	double asymmetric	92 %	18 pc(s).	0.311 kg
ACL LINEAR LENS 24x1800mm DASY	28002035	1,800 mm	double asymmetric	92 %	18 pc(s).	0.373 kg
ACL Endcap LENS 24mm PSF	28002669	-	-	-	3,600 pc(s).	0.003 kg

## ACL CLIP 4.3mm

Accessory



## Product description

- \_ Clip for fixation of LED modules with 4.3 mm holes
- \_ Fast snap on mounting (sheet thickness 0.5 – 1.0 mm for PUSH-FIX and 1 – 2 mm for PUSH-FIX Long)
- \_ For drilling hole 4 mm
- \_ Clip made of polycarbonate
- \_ Minimum sales quantity 500 pcs.

## Website

<http://www.tridonic.com/28001036>

## Ordering data

Type	Article number	Colour	Packaging, bag <sup>①</sup>	Weight per pc.
ACL CLIP 4.3mm PUSH-FIX	28001036	White	500 pc(s).	0.001 kg
ACL CLIP 4,3mm PUSH-FIX Long	28002314	Transparent	500 pc(s).	0.001 kg

① Minimum sales quantity 500 pcs.

## ACL BRIDGE LLE24/40

Accessory

**Product description**

- \_ Enables the fixation of 24 mm wide Tridonic LED modules to fixtures made for 40 mm wide modules
- \_ Ideal for extruded aluminium gear trays made for 40 mm modules with pre-alignment knobs
- \_ Clip-on for LINEAR COVER and LINEAR LENS <sup>①</sup>
- \_ For LLE 24 with 280 mm module minimum 2 bridges required
- \_ For LLE 24 with 560 mm module minimum 3 bridges required
- \_ Fixation via M3 or M4 countersunk screw, max. tightening torque 0.5 Nm
- \_ Material: white polycarbonate
- \_ Minimum sales quantity 600 pcs.

<sup>①</sup> Beam characteristics will change due to the elevated fixation (see photometric files for details).

**Website**

<http://www.tridonic.com/28001205>

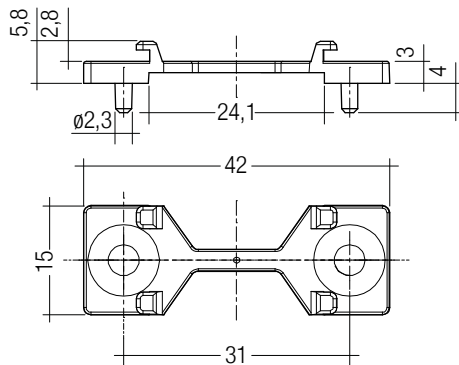
**Ordering data**

Type	Article number	Colour	Packaging, carton	Weight per pc.
ACL BRIDGE LLE24/40 SCREW-FIX	28001205	White	600 pc(s).	0.001 kg

## 1. Standards

IEC 62031  
 IEC 62471  
 IEC 61000-4-2  
 IEC 62778  
 IEC 61547  
 UL 8750 (for CLASS2 circuits and dry locations)

### 1.1 Photometric code

Key for photometric code, e. g. 830 / 349

1 <sup>st</sup> digit	2 <sup>nd</sup> + 3 <sup>rd</sup> digit	4 <sup>th</sup> digit	5 <sup>th</sup> digit	6 <sup>th</sup> digit	
Code	CRI	Colour temperature in Kelvin x 100	MacAdam initial	MacAdam after 25% of the lifetime (max.6000h)	
7	70 – 79			Luminous flux after 25% of the lifetime (max.6000h)	
8	80 – 89			Code	Luminous flux
9	≥90			7	≥ 70 %
				8	≥ 80 %
				9	≥ 90 %

### 1.2 Energy classification

Type	Colour temperature	Forward current	Energy classification	Energy consumption
LLE 24x140mm 650lm 827 LV ADV5	2,700 K	100 mA	C	4 kWh / 1,000 h
LLE 24x280mm 1250lm 827 LV ADV5	2,700 K	200 mA	C	7 kWh / 1,000 h
LLE 24x280mm 1250lm 830 LV ADV5	3,000 K	200 mA	C	7 kWh / 1,000 h
LLE 24x280mm 1250lm 835 LV ADV5	3,500 K	200 mA	C	7 kWh / 1,000 h
LLE 24x280mm 1250lm 840 LV ADV5	4,000 K	200 mA	C	7 kWh / 1,000 h
LLE 24x280mm 1250lm 865 LV ADV5	6,500 K	200 mA	C	7 kWh / 1,000 h
LLE 24x560mm 2400lm 827 LV ADV5	2,700 K	400 mA	C	14 kWh / 1,000 h
LLE 24x560mm 2400lm 830 LV ADV5	3,000 K	400 mA	C	14 kWh / 1,000 h
LLE 24x560mm 2400lm 835 LV ADV5	3,500 K	400 mA	C	14 kWh / 1,000 h
LLE 24x560mm 2400lm 840 LV ADV5	4,000 K	400 mA	C	14 kWh / 1,000 h
<b>Backside terminal</b>				
LLE 24x280mm 1250lm 840 LV ADV5 BT	4,000 K	200 mA	C	7 kWh / 1,000 h
LLE 24x560mm 2400lm 840 LV ADV5 BT	4,000 K	400 mA	C	14 kWh / 1,000 h

Energy label and further information at [www.tridonic.com](http://www.tridonic.com) in the certificates tab of the corresponding product page and at the EPREL data base <https://eprel.ec.europa.eu/>

## 2. Thermal details

### 2.1 tc point, ambient temperature and lifetime

The temperature at tp reference point is crucial for the light output and lifetime of a LED product.

For LLE a tp temperature of 50 °C has to be complied in order to achieve an optimum between heat sink requirements, light output and lifetime.

Compliance with the maximum permissible reference temperature at the tc point must be checked under operating conditions in a thermally stable state. The maximum value must be determined under worst-case conditions for the relevant application.

The tc and tp temperature of LED modules from Tridonic are measured at the same reference point.

### 2.2 Storage and humidity

Storage temperature	-40 ... +80 °C
---------------------	----------------

Operation only in non condensing environment.

Humidity during processing of the module should be between 30 to 70 %.

### 2.3 Heat sink values

#### LLE 24x140mm 650lm ADV5

ta	tp	Forward current	R <sub>th, hs-a</sub>	Cooling area
25 °C	50 °C	100 mA	14.72 K/W	45 cm <sup>2</sup>
25 °C	50 °C	165 mA	8.02 K/W	83 cm <sup>2</sup>
35 °C	50 °C	100 mA	8.83 K/W	76 cm <sup>2</sup>
35 °C	50 °C	165 mA	4.81 K/W	139 cm <sup>2</sup>
40 °C	50 °C	100 mA	5.88 K/W	113 cm <sup>2</sup>
40 °C	50 °C	165 mA	3.20 K/W	208 cm <sup>2</sup>
45 °C	50 °C	100 mA	2.93 K/W	227 cm <sup>2</sup>
45 °C	50 °C	165 mA	1.59 K/W	418 cm <sup>2</sup>

#### LLE 24x280mm 1250lm ADV5

ta	tp	Forward current	R <sub>th, hs-a</sub>	Cooling area
25 °C	50 °C	200 mA	7.31 K/W	91 cm <sup>2</sup>
25 °C	50 °C	330 mA	4.01 K/W	166 cm <sup>2</sup>
35 °C	50 °C	200 mA	4.38 K/W	152 cm <sup>2</sup>
35 °C	50 °C	330 mA	2.40 K/W	277 cm <sup>2</sup>
40 °C	50 °C	200 mA	2.92 K/W	228 cm <sup>2</sup>
40 °C	50 °C	330 mA	1.60 K/W	416 cm <sup>2</sup>
45 °C	50 °C	200 mA	1.46 K/W	458 cm <sup>2</sup>
45 °C	50 °C	330 mA	0.80 K/W	836 cm <sup>2</sup>

#### LLE 24x560mm 2400lm ADV5

ta	tp	Forward current	R <sub>th, hs-a</sub>	Cooling area
25 °C	50 °C	400 mA	3.66 K/W	182 cm <sup>2</sup>
25 °C	50 °C	660 mA	2.01 K/W	332 cm <sup>2</sup>
35 °C	50 °C	400 mA	2.19 K/W	258 cm <sup>2</sup>
35 °C	50 °C	660 mA	1.20 K/W	555 cm <sup>2</sup>
40 °C	50 °C	400 mA	1.46 K/W	457 cm <sup>2</sup>
40 °C	50 °C	660 mA	0.80 K/W	833 cm <sup>2</sup>
45 °C	50 °C	400 mA	0.73 K/W	915 cm <sup>2</sup>
45 °C	50 °C	660 mA	0.40 K/W	1,673 cm <sup>2</sup>

### Notes

The actual cooling surface can differ because of the material, the structural shape, outside influences and the installation situation. Depending on the heat sink a heat conducting paste or heat conducting film might be necessary to keep the specified tp temperature.

### 3. Installation / wiring

#### 3.1 Electrical supply/choice of LED driver

LLE modules from Tridonic are not protected against overvoltages, overcurrents, overloads or short-circuit currents. Safe and reliable operation can only be guaranteed in conjunction with a LED driver which complies with the relevant standards. The use of LED driver from Tridonic in combination with LLE modules guarantees the necessary protection for safe and reliable operation.

If a LED driver other than Tridonic is used, it must provide the following protection:

- Short-circuit protection
- Overload protection
- Overtemperature protection

**!** LLE modules must be supplied by a constant current LED driver. Operation with a constant voltage LED driver will lead to an irreversible damage of the module.

Wrong polarity can damage the LLE.

With parallel wiring tolerance-related differences in output are possible (thermal stress of the module) and can cause differences in brightness. For best homogeneity, only connect modules from one batch in parallel.

If a wire breaks or a complete module fails then the current passing through the other module increases. This may reduce its life considerably.

The max. permissible output current of the LED driver for parallel wiring is 3 A.

LLE have to be operated with SELV LED drivers.

**!** LLE are basic insulated up to 60 V SELV (if mounted with M4 screws with head diameter 7 mm in combination with plastic washers) against ground and can be mounted directly on earthed metal parts of the luminaire. If the max. output voltage of the LED driver (also against earth) is above 60 V SELV, an additional insulation between LED module and heat sink is required (for example by insulated thermal pads) or by a suitable luminaire construction.

#### 3.2 Wiring

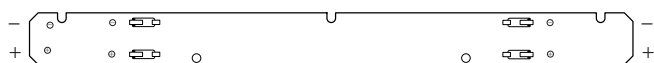

#### Wiring examples

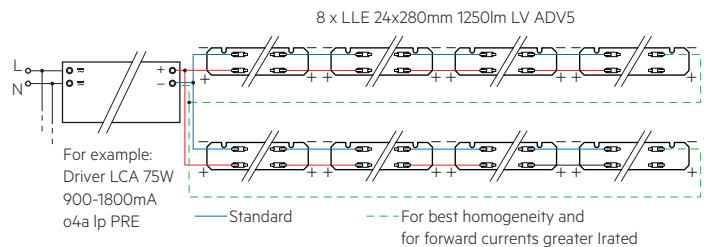
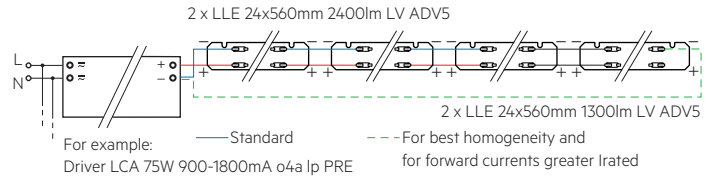
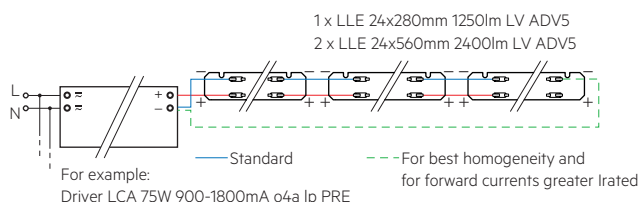
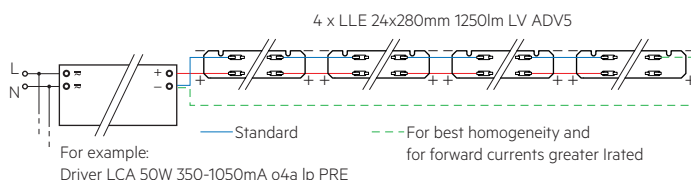

Type	Recommendation for max. number with parallel wiring*
LLE 24x280mm 1250lm LV ADV5	6
LLE 24x560mm 2400lm LV ADV5	3

\* with direkt chaining (without additional terminals).

#### 3.3 Wiring type and cross section

For wiring use stranded wire with ferrules or solid wire from 0.2 to 0.75 mm<sup>2</sup>. For the push-wire connection you have to strip the insulation (8–9 mm).

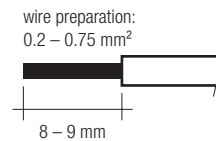

To remove the wires use a suitable tool (e.g. Microcon release pin) or through twist and pull.

#### 3.4 Mounting instruction

**!** None of the components of the LLE (substrate, LED, electronic components etc.) may be exposed to tensile or compressive stresses.

Max. torque for fixing: 0.5 Nm.

The LED modules are mounted onto a heat sink with min. 3 screws per module or ACL CLIP 4.3mm.

Only touch the module at the edge to separate the modules (see marking below).

Cut out on gear tray for backside terminal:

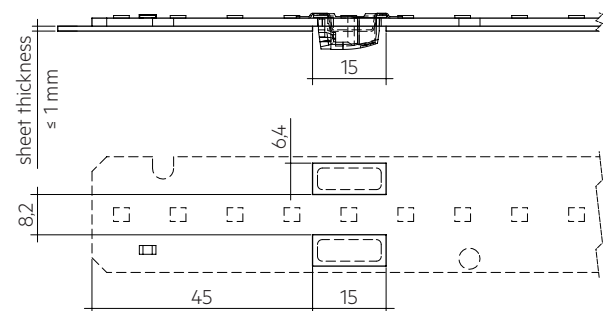



Chemical substance may harm the LED module. Chemical reactions could lead to colour shift, reduced luminous flux or a total failure of the module caused by corrosion of electrical connections.

Materials which are used in LED applications (e.g. sealings, adhesives) must not produce dissolver gas. They must not be condensation curing based, acetate curing based or contain sulfur, chlorine or phthalate.

Avoid corrosive atmosphere during usage and storage.

### 3.5 EOS/ESD safety guidelines



The device / module contains components that are sensitive to electrostatic discharge and may only be installed in the factory and on site if appropriate EOS/ESD protection measures have been taken. No special measures need be taken for devices/modules with enclosed casings (contact with the pc board not possible), just normal installation practice. Please note the requirements set out in the document EOS / ESD guidelines (Guideline\_EOS\_ESD.pdf) at: <http://www.tridonic.com/esd-protection>

## 4. Lifetime

### 4.1 Lifetime, lumen maintenance and failure rate

The light output of an LED module decreases over the lifetime, this is characterized with the L value.

L70 means that the LED module will give 70 % of its initial luminous flux.

This value is always related to the number of operation hours and therefore defines the lifetime of an LED module.

As the L value is a statistical value and the lumen maintenance may vary over the delivered LED modules.

The B value defines the amount of modules which are below the specific L value, e.g. L70B10 means 10 % of the LED modules are below 70 % of the initial luminous flux, respectively 90 % will be above 70 % of the initial value.

In addition the percentage of failed modules (fatal failure) is characterized by the C value.

The F value is the combination of the B and C value. That means for F degradation and complete failures are considered, e.g. L70F10 means 10 % of the LED modules may fail or be below 70 % of the initial luminous flux.

### 4.2 Lumen maintenance for LLE 24mm LV ADV5

Forward current	tp tempera- ture	L90 / F10 L90 / F50 L80 / F10 L80 / F50 L70 / F10 L70 / F50					
		40 °C	43,000 h	59,000 h	>72,000 h	>72,000 h	>72,000 h
	45 °C	42,000 h	57,000 h	>72,000 h	>72,000 h	>72,000 h	>72,000 h
	50 °C	41,000 h	55,000 h	>72,000 h	>72,000 h	>72,000 h	>72,000 h
100 mA / ft (280 mm module length)	55 °C	40,000 h	54,000 h	>72,000 h	>72,000 h	>72,000 h	>72,000 h
	60 °C	39,000 h	52,000 h	>72,000 h	>72,000 h	>72,000 h	>72,000 h
	65 °C	38,000 h	50,000 h	>72,000 h	>72,000 h	>72,000 h	>72,000 h
	70 °C	38,000 h	49,000 h	>72,000 h	>72,000 h	>72,000 h	>72,000 h
	75 °C	37,000 h	47,000 h	>72,000 h	>72,000 h	>72,000 h	>72,000 h
	80 °C	36,000 h	46,000 h	>72,000 h	>72,000 h	>72,000 h	>72,000 h
	85 °C	35,000 h	45,000 h	>72,000 h	>72,000 h	>72,000 h	>72,000 h
130 mA / ft (280 mm module length)	40 °C	43,000 h	58,000 h	>72,000 h	>72,000 h	>72,000 h	>72,000 h
	45 °C	42,000 h	57,000 h	>72,000 h	>72,000 h	>72,000 h	>72,000 h
	50 °C	41,000 h	55,000 h	>72,000 h	>72,000 h	>72,000 h	>72,000 h
	55 °C	40,000 h	53,000 h	>72,000 h	>72,000 h	>72,000 h	>72,000 h
	60 °C	39,000 h	51,000 h	>72,000 h	>72,000 h	>72,000 h	>72,000 h
	65 °C	38,000 h	50,000 h	>72,000 h	>72,000 h	>72,000 h	>72,000 h
	70 °C	37,000 h	48,000 h	>72,000 h	>72,000 h	>72,000 h	>72,000 h
	75 °C	36,000 h	47,000 h	>72,000 h	>72,000 h	>72,000 h	>72,000 h
	80 °C	36,000 h	45,000 h	>72,000 h	>72,000 h	>72,000 h	>72,000 h
	85 °C	35,000 h	44,000 h	>72,000 h	>72,000 h	>72,000 h	>72,000 h
200 mA / ft (280 mm module length)	40 °C	42,000 h	58,000 h	>72,000 h	>72,000 h	>72,000 h	>72,000 h
	45 °C	41,000 h	56,000 h	>72,000 h	>72,000 h	>72,000 h	>72,000 h
	50 °C	40,000 h	54,000 h	>72,000 h	>72,000 h	>72,000 h	>72,000 h
	55 °C	40,000 h	52,000 h	>72,000 h	>72,000 h	>72,000 h	>72,000 h
	60 °C	39,000 h	51,000 h	>72,000 h	>72,000 h	>72,000 h	>72,000 h
	65 °C	38,000 h	49,000 h	>72,000 h	>72,000 h	>72,000 h	>72,000 h
	70 °C	37,000 h	48,000 h	>72,000 h	>72,000 h	>72,000 h	>72,000 h
	75 °C	36,000 h	46,000 h	>72,000 h	>72,000 h	>72,000 h	>72,000 h
	80 °C	35,000 h	45,000 h	>72,000 h	>72,000 h	>72,000 h	>72,000 h
	85 °C	34,000 h	44,000 h	70,000 h	>72,000 h	>72,000 h	>72,000 h
250 mA / ft (280 mm module length)	40 °C	42,000 h	57,000 h	>72,000 h	>72,000 h	>72,000 h	>72,000 h
	45 °C	41,000 h	55,000 h	>72,000 h	>72,000 h	>72,000 h	>72,000 h
	50 °C	40,000 h	54,000 h	>72,000 h	>72,000 h	>72,000 h	>72,000 h
	55 °C	39,000 h	52,000 h	>72,000 h	>72,000 h	>72,000 h	>72,000 h
	60 °C	38,000 h	50,000 h	>72,000 h	>72,000 h	>72,000 h	>72,000 h
	65 °C	37,000 h	49,000 h	>72,000 h	>72,000 h	>72,000 h	>72,000 h
	70 °C	37,000 h	47,000 h	>72,000 h	>72,000 h	>72,000 h	>72,000 h
	75 °C	36,000 h	46,000 h	>72,000 h	>72,000 h	>72,000 h	>72,000 h
	80 °C	35,000 h	44,000 h	71,000 h	>72,000 h	>72,000 h	>72,000 h
	85 °C	34,000 h	43,000 h	69,000 h	>72,000 h	>72,000 h	>72,000 h
300 mA / ft (280 mm module length)	40 °C	42,000 h	56,000 h	>72,000 h	>72,000 h	>72,000 h	>72,000 h
	45 °C	41,000 h	55,000 h	>72,000 h	>72,000 h	>72,000 h	>72,000 h
	50 °C	40,000 h	53,000 h	>72,000 h	>72,000 h	>72,000 h	>72,000 h
	55 °C	39,000 h	51,000 h	>72,000 h	>72,000 h	>72,000 h	>72,000 h
	60 °C	38,000 h	50,000 h	>72,000 h	>72,000 h	>72,000 h	>72,000 h
	65 °C	37,000 h	48,000 h	>72,000 h	>72,000 h	>72,000 h	>72,000 h
	70 °C	36,000 h	47,000 h	>72,000 h	>72,000 h	>72,000 h	>72,000 h
	75 °C	35,000 h	45,000 h	>72,000 h	>72,000 h	>72,000 h	>72,000 h
	80 °C	35,000 h	44,000 h	70,000 h	>72,000 h	>72,000 h	>72,000 h
	85 °C	34,000 h	43,000 h	69,000 h	>72,000 h	>72,000 h	>72,000 h
330 mA / ft (280 mm module length)	40 °C	41,000 h	56,000 h	>72,000 h	>72,000 h	>72,000 h	>72,000 h
	45 °C	40,000 h	54,000 h	>72,000 h	>72,000 h	>72,000 h	>72,000 h
	50 °C	39,000 h	52,000 h	>72,000 h	>72,000 h	>72,000 h	>72,000 h
	55 °C	38,000 h	51,000 h	>72,000 h	>72,000 h	>72,000 h	>72,000 h
	60 °C	38,000 h	49,000 h	>72,000 h	>72,000 h	>72,000 h	>72,000 h
	65 °C	37,000 h	48,000 h	>72,000 h	>72,000 h	>72,000 h	>72,000 h
	70 °C	36,000 h	46,000 h	>72,000 h	>72,000 h	>72,000 h	>72,000 h
	75 °C	35,000 h	45,000 h	71,000 h	>72,000 h	>72,000 h	>72,000 h
	80 °C	34,000 h	43,000 h	70,000 h	>72,000 h	>72,000 h	>72,000 h
	85 °C	34,000 h	42,000 h	68,000 h	>72,000 h	>72,000 h	>72,000 h

### 4.3 Switching capability

100,000 cycles

Tridonic test according to IEC 62717 Cl 10.3.3

30 s on / 30 s off at I<sub>max</sub>

## 5. Electrical values

### 5.1 Declaration of electrical parameters

Irated ... Nominal operating current the module is designed for.

I<sub>max</sub> ... Max. permissible continuous operating current incl. The tolerances of the LED driver.

Max. permissible LF current ripple ... Max. output current of the LED driver incl. Tolerances and LF current ripple must not exceed this value.

Max. permissible peak current ... The max. output peak current of the LED driver must not exceed this value.

### 5.2 Typ. forward voltage vs. forward current

#### LLE 24x140mm 650lm 8xx LV ADV5

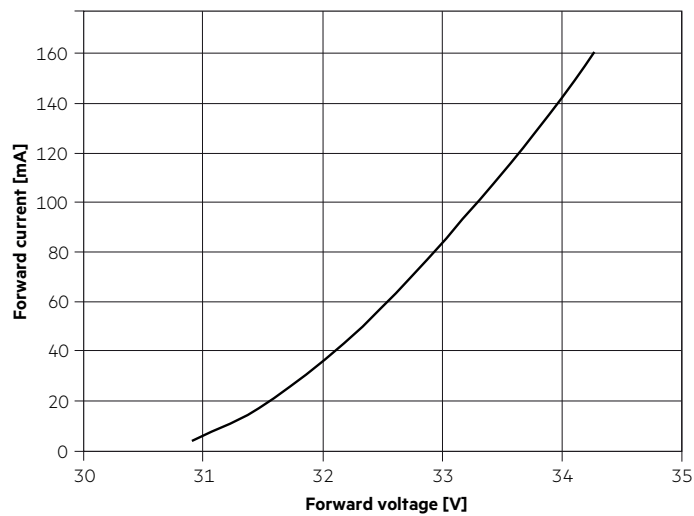

#### LLE 24x280mm 1250lm 8xx LV ADV5

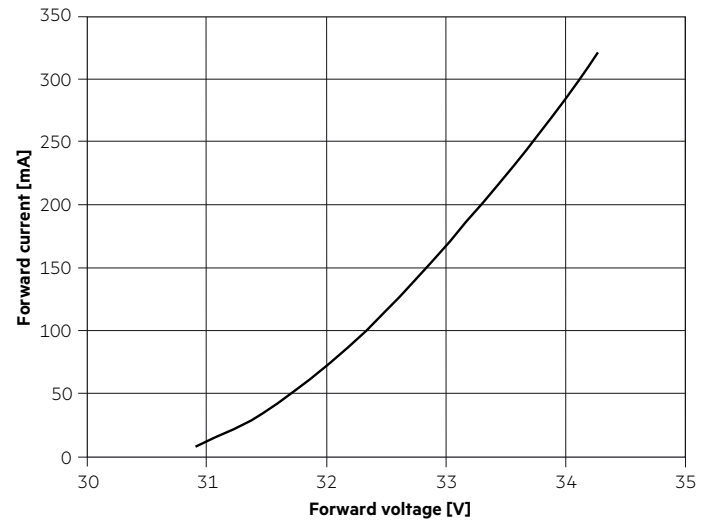

#### LLE 24x560mm 2400lm 8xx LV ADV5

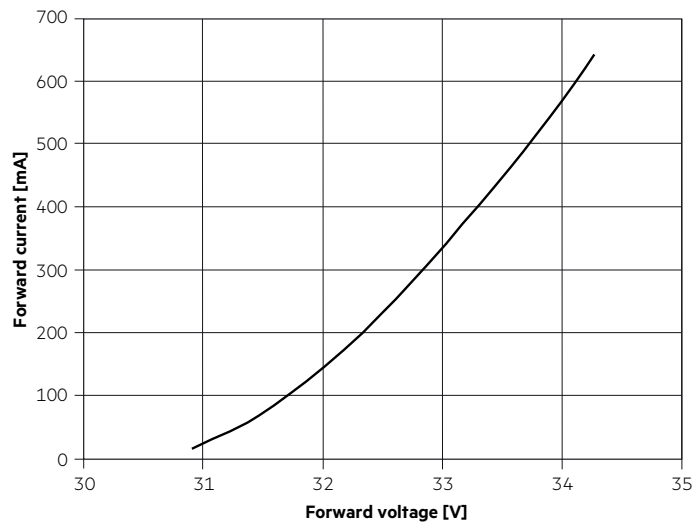

### 5.3 Forward voltage vs. tc temperature

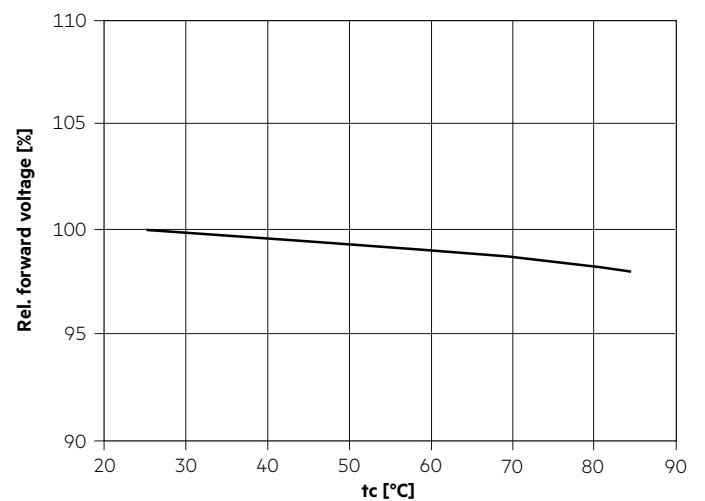

The diagrams are based on statistic values.  
The real values can be different.

## 6. Photometric characteristics

### 6.1 Coordinates and tolerances according to CIE 1931

The specified colour coordinates are integral measured by current impulse of 195 mA and a duration of 100 ms.

The ambient temperature of the measurement is  $t_a = 25^\circ\text{C}$ .

The measurement tolerance of the colour coordinates are  $\pm 0.01$ .

#### 2,700 K

	x0	y0
Centre	0.4578	0.4101

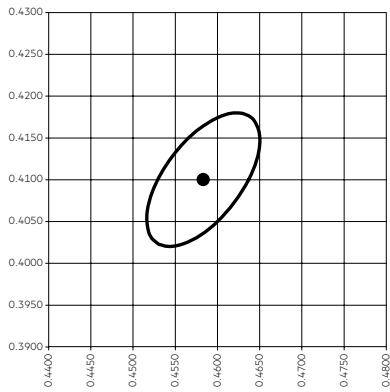

— MacAdam Ellipse: 3SDCM

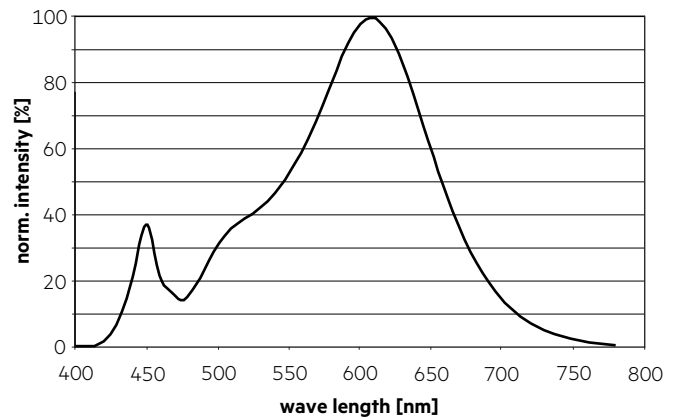

#### 3,000 K

	x0	y0
Centre	0.4338	0.4030

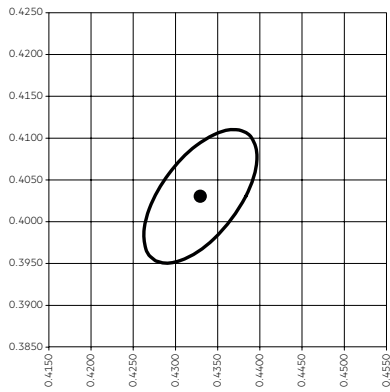

— MacAdam Ellipse: 3SDCM

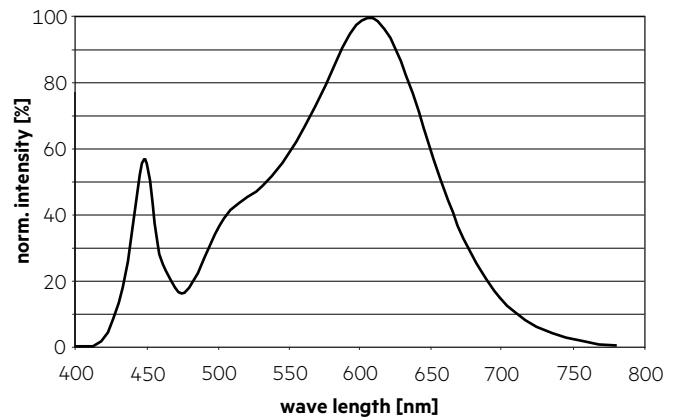

#### 3,500 K

	x0	y0
Centre	0.4073	0.3917

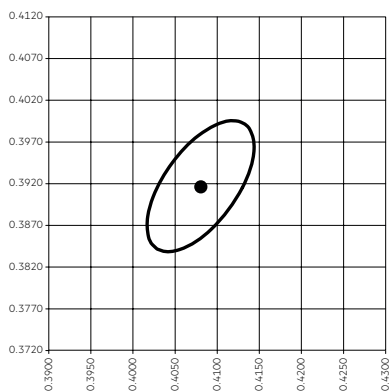

— MacAdam Ellipse: 3SDCM

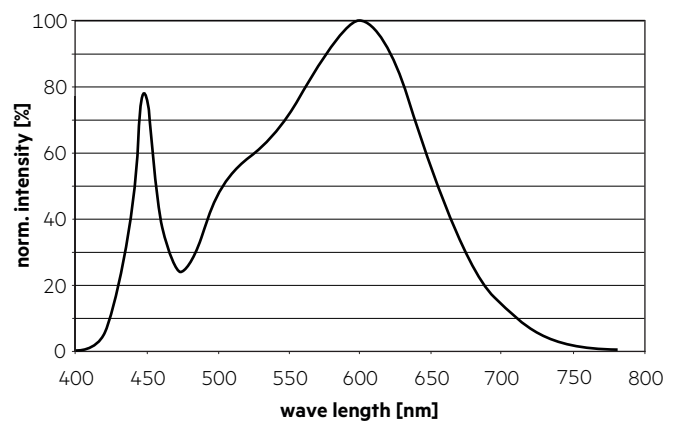

**4,000 K**

	x0	y0
Center	0.3818	0.3797

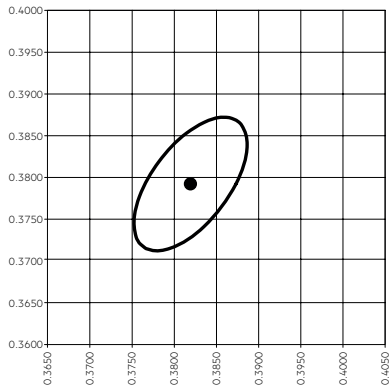

— MacAdam Ellipse: 3SDCM

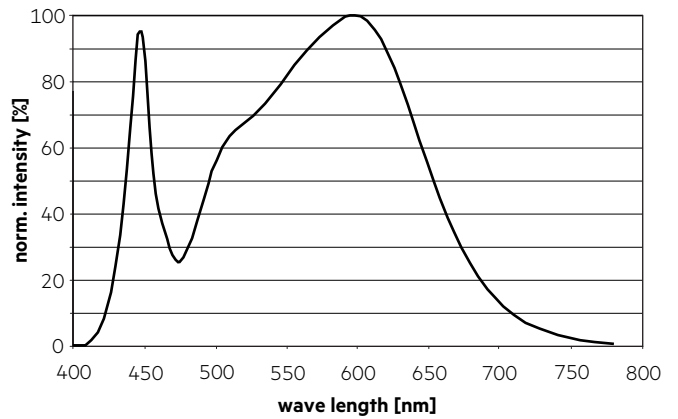

**6,500 K**

	x0	y0
Center	0.3123	0.3282

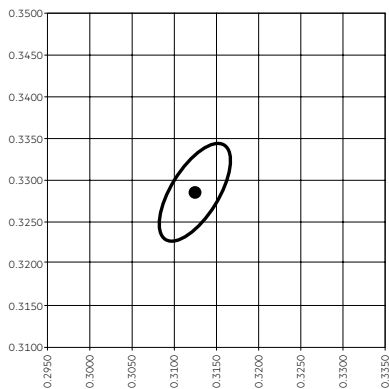

— MacAdam Ellipse: 3SDCM

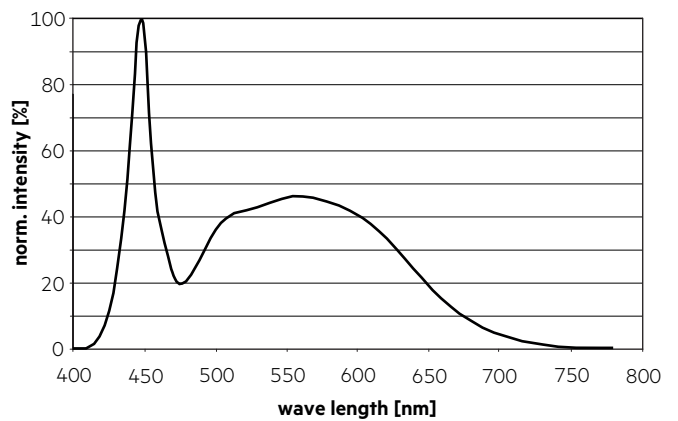

**6.2 Light distribution**

The optical design of the LLE product line ensures optimum homogeneity for the light distribution.

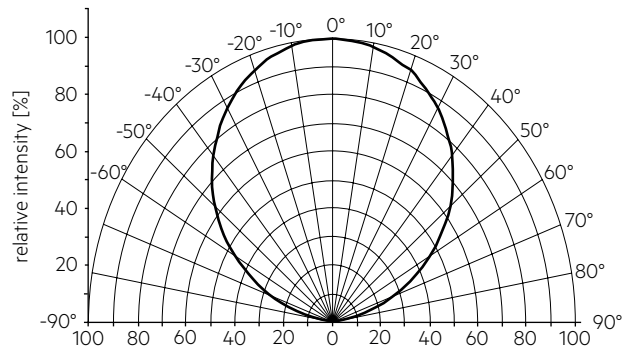

The colour temperature is measured integral over the complete module. The single LED light points can have deviations in the colour coordinates within MacAdam 5.

To ensure an ideal mixture of colours and a homogeneous light distribution a suitable optic (e. g. PMMA diffuser) and a sufficient spacing between module and optic (typ. 4 cm) should be used.

6.3 Relative luminous flux vs. tc temperature

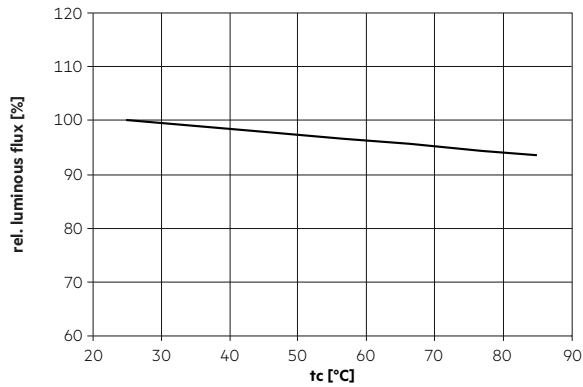

6.4 Relative luminous flux vs. operating current

LLE 24x140mm 650lm 8xx LV ADV5

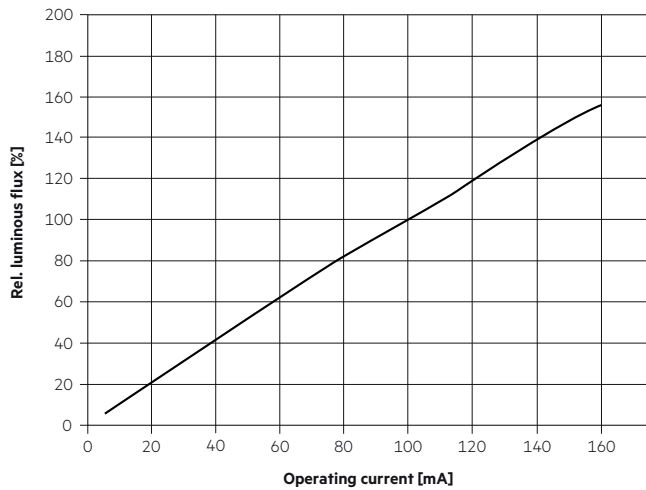

LLE 24x280mm 1250lm 8xx LV ADV5

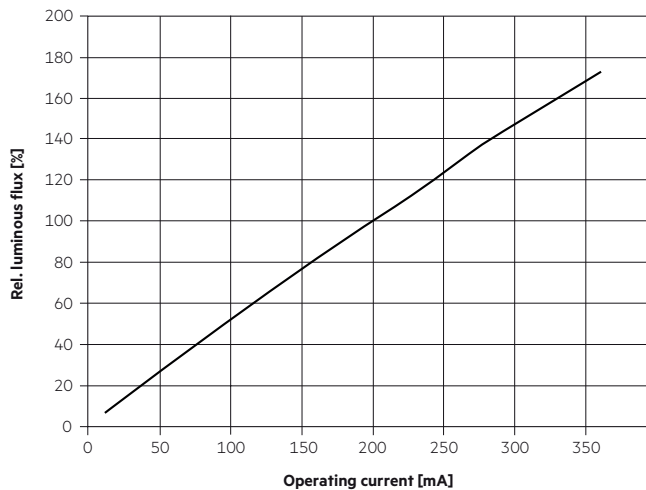

LLE 24x560mm 2400lm 8xx LV ADV5

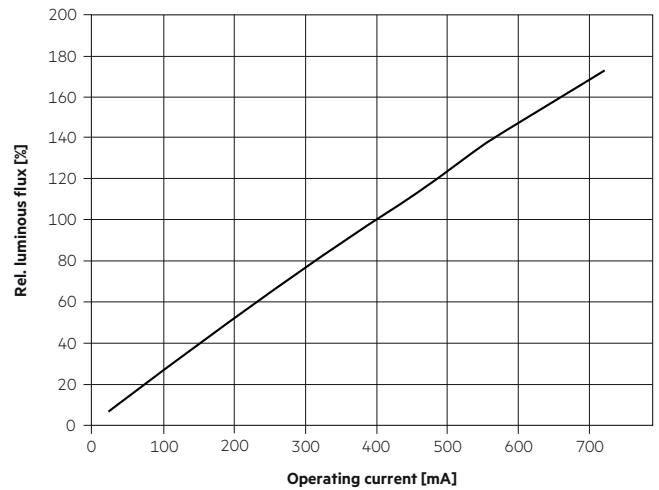

The diagrams are based on statistic values.  
The real values can be different.

7. Miscellaneous

7.1 Additional information

Additional technical information at [www.tridonic.com](http://www.tridonic.com) → Technical Data

Guarantee conditions at [www.tridonic.com](http://www.tridonic.com) → Services

Lifetime declarations are informative and represent no warranty claim.