

Module LLE 24mm 1250lm HV ADV6

Modules LLE advanced



LLE 24x70mm 325lm HV ADV6



LLE 24x140mm 650lm HV ADV6



LLE 24x280mm 1250lm HV ADV6

Product description

- _ Ideal for linear and panel lights
- _ 2 terminals for serial wiring
- _ Perfectly uniform light, even if several LED modules are used together in a line
- _ Push terminals for quick and simple wiring of LED module to LED module
- _ Broad portfolio from extruded lenses and covers available
- _ HE ... High Efficiency, NM ... Nominal Mode, HO ... High Output
- _ Min. order quantity LLE 24x70mm QTY4: 36 pcs. The LLE 24x70mm QTY4 module contains 4 single 24x70mm modules which have to be separated
- _ Long lifetime up to 102,000 hours
- _ 5 years guarantee (conditions at <https://www.tridonic.com/en/int/services/manufacturer-guarantee-conditions>)

Optical properties

- _ Colour temperatures 2,700, 3,000, 4,000, 5,000 and 6,500 K
- _ Efficacy of the LED module 205 lm/W at Irated and tp = 25 °C
- _ High colour rendering index CRI > 80
- _ High colour consistency (MacAdam 3) ①
- _ Small luminous flux tolerances

Mechanical properties

- _ Module dimension 24 x 70 mm, 24 x 140 mm, 24 x 280 mm and 24 x 560 mm (ZHAGA compliant)
- _ Simple installation via clips or screws

System solution

- _ Combine Tridonic's LED modules and dimmable drivers to achieve an outstanding system efficacy (configuration possible via <https://setbuilder.tridonic.com/>)

① Integral measurement over the complete module.

Website

<http://www.tridonic.com/28004724>

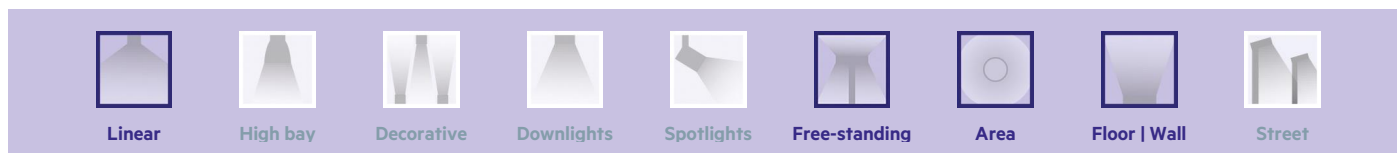
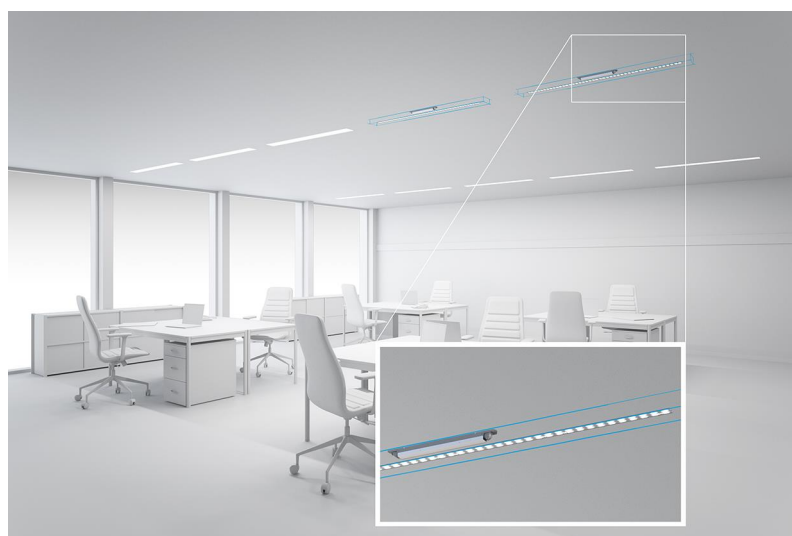

Module LLE 24mm 1250lm HV ADV6

Modules LLE advanced

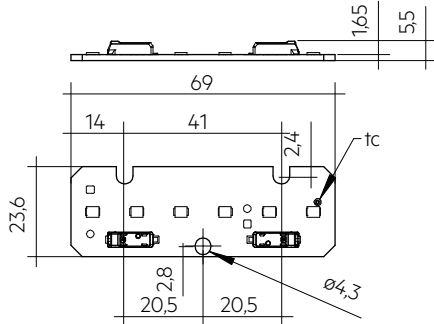

LLE 24x70mm 325lm HV ADV6

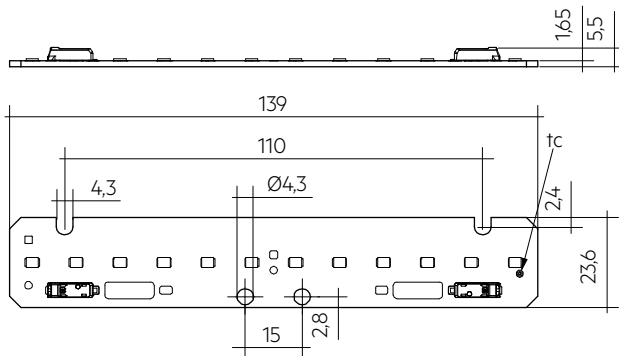

LLE 24x140mm 650lm HV ADV6

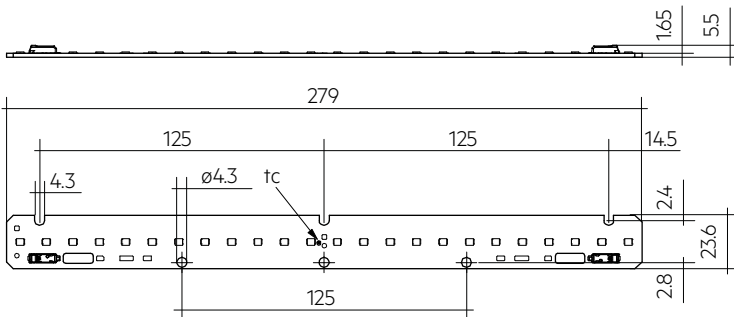

LLE 24x280mm 1250lm HV ADV6

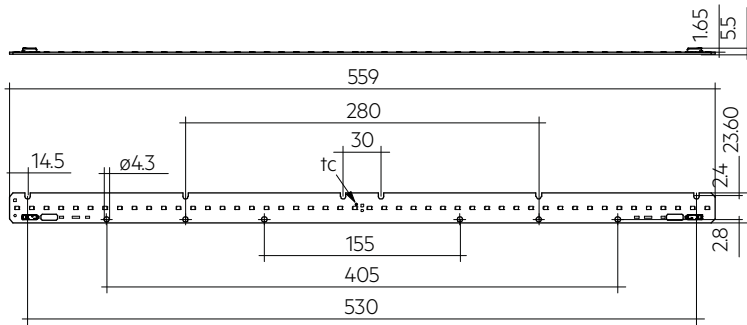

LLE 24x560mm 2400lm HV ADV6

Ordering data

Type	Article number	Colour temperature	Packaging, carton	Weight per pc.
LLE 24x70mm 325lm 827 HV ADV6 QTY4	28004724	2,700 K	108 pc(s).	0.022 kg
LLE 24x70mm 325lm 830 HV ADV6 QTY4	28004725	3,000 K	108 pc(s).	0.022 kg
LLE 24x70mm 325lm 835 HV ADV6 QTY4	28004726	3,500 K	108 pc(s).	0.022 kg
LLE 24x70mm 325lm 840 HV ADV6 QTY4	28004727	4,000 K	108 pc(s).	0.022 kg
LLE 24x70mm 325lm 850 HV ADV6 QTY4	28004729	5,000 K	108 pc(s).	0.022 kg
LLE 24x70mm 325lm 865 HV ADV6 QTY4	28004730	6,500 K	108 pc(s).	0.022 kg
LLE 24x140mm 650lm 827 HV ADV6	28004750	2,700 K	108 pc(s).	0.011 kg
LLE 24x140mm 650lm 830 HV ADV6	28004751	3,000 K	108 pc(s).	0.011 kg
LLE 24x140mm 650lm 835 HV ADV6	28004752	3,500 K	108 pc(s).	0.011 kg
LLE 24x140mm 650lm 840 HV ADV6	28004753	4,000 K	108 pc(s).	0.011 kg
LLE 24x140mm 650lm 850 HV ADV6	28004754	5,000 K	108 pc(s).	0.011 kg
LLE 24x140mm 650lm 865 HV ADV6	28004755	6,500 K	108 pc(s).	0.011 kg
LLE 24x280mm 1250lm 827 HV ADV6	28004760	2,700 K	108 pc(s).	0.023 kg
LLE 24x280mm 1250lm 830 HV ADV6	28004761	3,000 K	108 pc(s).	0.023 kg
LLE 24x280mm 1250lm 835 HV ADV6	28004762	3,500 K	108 pc(s).	0.023 kg
LLE 24x280mm 1250lm 840 HV ADV6	28004763	4,000 K	108 pc(s).	0.023 kg
LLE 24x280mm 1250lm 840 HV ADV6 BT	28004764	4,000 K	210 pc(s).	0.023 kg
LLE 24x280mm 1250lm 850 HV ADV6	28004765	5,000 K	108 pc(s).	0.023 kg
LLE 24x280mm 1250lm 865 HV ADV6	28004766	6,500 K	108 pc(s).	0.023 kg
LLE 24x560mm 2400lm 827 HV ADV6	28004771	2,700 K	108 pc(s).	0.041 kg
LLE 24x560mm 2400lm 830 HV ADV6	28004772	3,000 K	108 pc(s).	0.041 kg
LLE 24x560mm 2400lm 835 HV ADV6	28004773	3,500 K	108 pc(s).	0.041 kg
LLE 24x560mm 2400lm 840 HV ADV6	28004774	4,000 K	108 pc(s).	0.041 kg
LLE 24x560mm 2400lm 840 HV ADV6 BT	28004775	4,000 K	144 pc(s).	0.041 kg
LLE 24x560mm 2400lm 850 HV ADV6	28004776	5,000 K	108 pc(s).	0.041 kg
LLE 24x560mm 2400lm 865 HV ADV6	28004777	6,500 K	108 pc(s).	0.041 kg

Technical data

Beam characteristic	120°
Ambient temperature t_a	-40 ... +65 °C
t_p rated	50 °C
t_c	85 °C
I_{rated}	275 mA
I_{max}	800 mA
Max. permissible LF current ripple	900 mA
Max. permissible peak current	1,350 mA / max. 10 ms
Max. working voltage for insulation [®]	440 V
Insulation test voltage	1.88 kV
Colour tolerance	3 SDCM
ESD classification	Severity level 2
Risk group (IEC 62471)	RG1 (> 280 – 800 mA (I_{max})), RGO (\leq 280 mA)
Classification acc. to IEC 62031	Built-in
Type of protection	IP00
Lumen maintenance L70B50	102,000 h
Guarantee (conditions at www.tridonic.com)	5 Year(s)

Approval marks

Standards

IEC 62031, IEC 62471, IEC 61000-4-2, IEC 62778, IEC 61547

Specific technical data

Type	Article number	Photometric code	Useful luminous flux at tp = 25 °C	Expected luminous flux at tp rated	Typ. forward current	Min. forward voltage at tp rated	Max. forward voltage at tp = 25 °C	Power consumption P _{on} at tp = 25 °C	Efficacy of the module at tp = 25 °C	Expected efficacy of the module at tp rated	Colour rendering index CRI
Operating mode HE											
LLE 24x70mm 325lm 827 HV ADV6 QTY4	28004724	827/359	-	102 lm	100 mA	5.0 V	5.5 V	-	-	193 lm/W	>80
LLE 24x70mm 325lm 830 HV ADV6 QTY4	28004725	830/359	-	104 lm	100 mA	5.0 V	5.5 V	-	-	197 lm/W	>80
LLE 24x70mm 325lm 835 HV ADV6 QTY4	28004726	835/359	-	108 lm	100 mA	5.0 V	5.5 V	-	-	204 lm/W	>80
LLE 24x70mm 325lm 840 HV ADV6 QTY4	28004727	840/359	-	110 lm	100 mA	5.0 V	5.5 V	-	-	209 lm/W	>80
LLE 24x70mm 325lm 850 HV ADV6 QTY4	28004729	850/359	-	110 lm	100 mA	5.0 V	5.5 V	-	-	208 lm/W	>80
LLE 24x70mm 325lm 865 HV ADV6 QTY4	28004730	865/359	-	108 lm	100 mA	5.0 V	5.5 V	-	-	205 lm/W	>80
LLE 24x140mm 650lm 827 HV ADV6	28004750	827/359	-	203 lm	100 mA	10.1 V	11.0 V	-	-	193 lm/W	>80
LLE 24x140mm 650lm 830 HV ADV6	28004751	830/359	-	208 lm	100 mA	10.1 V	11.0 V	-	-	197 lm/W	>80
LLE 24x140mm 650lm 835 HV ADV6	28004752	835/359	-	215 lm	100 mA	10.1 V	11.0 V	-	-	204 lm/W	>80
LLE 24x140mm 650lm 840 HV ADV6	28004753	840/359	-	221 lm	100 mA	10.1 V	11.0 V	-	-	209 lm/W	>80
LLE 24x140mm 650lm 850 HV ADV6	28004754	850/359	-	219 lm	100 mA	10.1 V	11.0 V	-	-	208 lm/W	>80
LLE 24x140mm 650lm 865 HV ADV6	28004755	865/359	-	216 lm	100 mA	10.1 V	11.0 V	-	-	205 lm/W	>80
LLE 24x280mm 1250lm 827 HV ADV6	28004760	827/359	-	407 lm	100 mA	20.2 V	22.0 V	-	-	193 lm/W	>80
LLE 24x280mm 1250lm 830 HV ADV6	28004761	830/359	-	416 lm	100 mA	20.2 V	22.0 V	-	-	197 lm/W	>80
LLE 24x280mm 1250lm 835 HV ADV6	28004762	835/359	-	430 lm	100 mA	20.2 V	22.0 V	-	-	204 lm/W	>80
LLE 24x280mm 1250lm 840 HV ADV6	28004763	840/359	-	442 lm	100 mA	20.2 V	22.0 V	-	-	209 lm/W	>80
LLE 24x280mm 1250lm 840 HV ADV6 BT	28004764	840/359	-	442 lm	100 mA	20.2 V	22.0 V	-	-	209 lm/W	>80
LLE 24x280mm 1250lm 850 HV ADV6	28004765	850/359	-	439 lm	100 mA	20.2 V	22.0 V	-	-	208 lm/W	>80
LLE 24x280mm 1250lm 865 HV ADV6	28004766	865/359	-	433 lm	100 mA	20.2 V	22.0 V	-	-	205 lm/W	>80
LLE 24x560mm 2400lm 827 HV ADV6	28004771	827/359	-	814 lm	100 mA	40.3 V	43.9 V	-	-	193 lm/W	>80
LLE 24x560mm 2400lm 830 HV ADV6	28004772	830/359	-	832 lm	100 mA	40.3 V	43.9 V	-	-	197 lm/W	>80
LLE 24x560mm 2400lm 835 HV ADV6	28004773	835/359	-	861 lm	100 mA	40.3 V	43.9 V	-	-	204 lm/W	>80
LLE 24x560mm 2400lm 840 HV ADV6	28004774	840/359	-	883 lm	100 mA	40.3 V	43.9 V	-	-	209 lm/W	>80
LLE 24x560mm 2400lm 840 HV ADV6 BT	28004775	840/359	-	883 lm	100 mA	40.3 V	43.9 V	-	-	209 lm/W	>80
LLE 24x560mm 2400lm 850 HV ADV6	28004776	850/359	-	877 lm	100 mA	40.3 V	43.9 V	-	-	208 lm/W	>80
LLE 24x560mm 2400lm 865 HV ADV6	28004777	865/359	-	866 lm	100 mA	40.3 V	43.9 V	-	-	205 lm/W	>80
Operating mode NM											
LLE 24x70mm 325lm 827 HV ADV6 QTY4	28004724	827/359	286 lm	274 lm	275 mA	5.2 V	5.7 V	1.5 W	189 lm/W	183 lm/W	>80
LLE 24x70mm 325lm 830 HV ADV6 QTY4	28004725	830/359	293 lm	281 lm	275 mA	5.2 V	5.7 V	1.5 W	193 lm/W	187 lm/W	>80
LLE 24x70mm 325lm 835 HV ADV6 QTY4	28004726	835/359	302 lm	290 lm	275 mA	5.2 V	5.7 V	1.5 W	200 lm/W	193 lm/W	>80
LLE 24x70mm 325lm 840 HV ADV6 QTY4	28004727	840/359	310 lm	298 lm	275 mA	5.2 V	5.7 V	1.5 W	205 lm/W	198 lm/W	>80
LLE 24x70mm 325lm 850 HV ADV6 QTY4	28004729	850/359	308 lm	296 lm	275 mA	5.2 V	5.7 V	1.5 W	203 lm/W	197 lm/W	>80
LLE 24x70mm 325lm 865 HV ADV6 QTY4	28004730	865/359	304 lm	292 lm	275 mA	5.2 V	5.7 V	1.5 W	201 lm/W	194 lm/W	>80
LLE 24x140mm 650lm 827 HV ADV6	28004750	827/359	572 lm	549 lm	275 mA	10.4 V	11.4 V	3.0 W	188 lm/W	183 lm/W	>80
LLE 24x140mm 650lm 830 HV ADV6	28004751	830/359	585 lm	562 lm	275 mA	10.4 V	11.4 V	3.0 W	193 lm/W	187 lm/W	>80
LLE 24x140mm 650lm 835 HV ADV6	28004752	835/359	605 lm	581 lm	275 mA	10.4 V	11.4 V	3.0 W	199 lm/W	193 lm/W	>80
LLE 24x140mm 650lm 840 HV ADV6	28004753	840/359	621 lm	596 lm	275 mA	10.4 V	11.4 V	3.0 W	205 lm/W	198 lm/W	>80
LLE 24x140mm 650lm 850 HV ADV6	28004754	850/359	617 lm	592 lm	275 mA	10.4 V	11.4 V	3.0 W	203 lm/W	197 lm/W	>80
LLE 24x140mm 650lm 865 HV ADV6	28004755	865/359	608 lm	584 lm	275 mA	10.4 V	11.4 V	3.0 W	201 lm/W	194 lm/W	>80
LLE 24x280mm 1250lm 827 HV ADV6	28004760	827/359	1,144 lm	1,098 lm	275 mA	20.9 V	22.7 V	6.1 W	188 lm/W	183 lm/W	>80
LLE 24x280mm 1250lm 830 HV ADV6	28004761	830/359	1,170 lm	1,123 lm	275 mA	20.9 V	22.7 V	6.1 W	193 lm/W	187 lm/W	>80
LLE 24x280mm 1250lm 835 HV ADV6	28004762	835/359	1,210 lm	1,161 lm	275 mA	20.9 V	22.7 V	6.1 W	199 lm/W	193 lm/W	>80
LLE 24x280mm 1250lm 840 HV ADV6	28004763	840/359	1,241 lm	1,191 lm	275 mA	20.9 V	22.7 V	6.1 W	205 lm/W	198 lm/W	>80
LLE 24x280mm 1250lm 840 HV ADV6 BT	28004764	840/359	1,241 lm	1,191 lm	275 mA	20.9 V	22.7 V	6.1 W	205 lm/W	198 lm/W	>80
LLE 24x280mm 1250lm 850 HV ADV6	28004765	850/359	1,233 lm	1,183 lm	275 mA	20.9 V	22.7 V	6.1 W	203 lm/W	197 lm/W	>80
LLE 24x280mm 1250lm 865 HV ADV6	28004766	865/359	1,216 lm	1,168 lm	275 mA	20.9 V	22.7 V	6.1 W	201 lm/W	194 lm/W	>80
LLE 24x560mm 2400lm 827 HV ADV6	28004771	827/359	2,287 lm	2,195 lm	275 mA	41.8 V	45.4 V	12.1 W	189 lm/W	183 lm/W	>80
LLE 24x560mm 2400lm 830 HV ADV6	28004772	830/359	2,340 lm	2,246 lm	275 mA	41.8 V	45.4 V	12.1 W	193 lm/W	187 lm/W	>80
LLE 24x560mm 2400lm 835 HV ADV6	28004773	835/359	2,420 lm	2,322 lm	275 mA	41.8 V	45.4 V	12.1 W	199 lm/W	193 lm/W	>80
LLE 24x560mm 2400lm 840 HV ADV6	28004774	840/359	2,482 lm	2,382 lm	275 mA	41.8 V	45.4 V	12.1 W	205 lm/W	198 lm/W	>80
LLE 24x560mm 2400lm 840 HV ADV6 BT	28004775	840/359	2,482 lm	2,382 lm	275 mA	41.8 V	45.4 V	12.1 W	205 lm/W	198 lm/W	>80
LLE 24x560mm 2400lm 850 HV ADV6	28004776	850/359	2,466 lm	2,367 lm	275 mA	41.8 V	45.4 V	12.1 W	203 lm/W	197 lm/W	>80
LLE 24x560mm 2400lm 865 HV ADV6	28004777	865/359	2,433 lm	2,335 lm	275 mA	41.8 V	45.4 V	12.1 W	201 lm/W	194 lm/W	>80
Operating mode HO											
LLE 24x70mm 325lm 827 HV ADV6 QTY4	28004724	827/359	-	651 lm	700 mA	5.5 V	6.0 V	-	-	160 lm/W	>80
LLE 24x70mm 325lm 830 HV ADV6 QTY4	28004725	830/359	-	667 lm	700 mA	5.5 V	6.0 V	-	-	164 lm/W	>80
LLE 24x70mm 325lm 835 HV ADV6 QTY4	28004726	835/359	-	689 lm	700 mA	5.5 V	6.0 V	-	-	170 lm/W	>80
LLE 24x70mm 325lm 840 HV ADV6 QTY4	28004727	840/359	-	707 lm	700 mA	5.5 V	6.0 V	-	-	174 lm/W	>80
LLE 24x70mm 325lm 850 HV ADV6 QTY4	28004729	850/359	-	702 lm	700 mA	5.5 V	6.0 V	-	-	173 lm/W	>80
LLE 24x70mm 325lm 865 HV ADV6 QTY4	28004730	865/359	-	693 lm	700 mA	5.5 V	6.0 V	-	-	171 lm/W	>80
LLE 24x140mm 650lm 827 HV ADV6	28004750	827/359	-	1,303 lm	700 mA	11.1 V	12.0 V	-	-	161 lm/W	>80
LLE 24x140mm 650lm 830 HV ADV6	28004751	830/359	-	1,333 lm	700 mA	11.1 V	12.0 V	-	-	164 lm/W	>80
LLE 24x140mm 650lm 835 HV ADV6	28004752	835/359	-	1,378 lm	700 mA	11.1 V	12.0 V	-	-	170 lm/W	>80
LLE 24x140mm 650lm 840 HV ADV6	28004753	840/359	-	1,414 lm	700 mA	11.1 V	12.0 V	-	-	174 lm/W	>80
LLE 24x140mm 650lm 850 HV ADV6	28004754	850/359	-	1,405 lm	700 mA	11.1 V	12.0 V	-	-	173 lm/W	>80
LLE 24x140mm 650lm 865 HV ADV6	28004755	865/359	-	1,386 lm	700 mA	11.1 V	12.0 V	-	-	171 lm/W	>80

Type	Article number	Photometric code ^②	Useful luminous flux at tp = 25 °C ^③	Expected luminous flux at tp rated ^④	Typ. forward current	Min. forward voltage at tp rated ^⑤	Max. forward voltage at tp = 25 °C	Power consumption Pon at tp = 25 °C ^⑥	Efficacy of the module at tp = 25 °C	Expected efficacy of the module at tp rated	Colour rendering index CRI
LLE 24x280mm 1250lm 827 HV ADV6	28004760	827/359	-	2,606 lm	700 mA	22.2 V	24.0 V	-	-	161 lm/W	>80
LLE 24x280mm 1250lm 830 HV ADV6	28004761	830/359	-	2,666 lm	700 mA	22.2 V	24.0 V	-	-	164 lm/W	>80
LLE 24x280mm 1250lm 835 HV ADV6	28004762	835/359	-	2,757 lm	700 mA	22.2 V	24.0 V	-	-	170 lm/W	>80
LLE 24x280mm 1250lm 840 HV ADV6	28004763	840/359	-	2,828 lm	700 mA	22.2 V	24.0 V	-	-	174 lm/W	>80
LLE 24x280mm 1250lm 840 HV ADV6 BT	28004764	840/359	-	2,828 lm	700 mA	22.2 V	24.0 V	-	-	174 lm/W	>80
LLE 24x280mm 1250lm 850 HV ADV6	28004765	850/359	-	2,809 lm	700 mA	22.2 V	24.0 V	-	-	173 lm/W	>80
LLE 24x280mm 1250lm 865 HV ADV6	28004766	865/359	-	2,772 lm	700 mA	22.2 V	24.0 V	-	-	171 lm/W	>80
LLE 24x560mm 2400lm 827 HV ADV6	28004771	827/359	-	5,211 lm	700 mA	44.4 V	48.1 V	-	-	161 lm/W	>80
LLE 24x560mm 2400lm 830 HV ADV6	28004772	830/359	-	5,332 lm	700 mA	44.4 V	48.1 V	-	-	164 lm/W	>80
LLE 24x560mm 2400lm 835 HV ADV6	28004773	835/359	-	5,513 lm	700 mA	44.4 V	48.1 V	-	-	170 lm/W	>80
LLE 24x560mm 2400lm 840 HV ADV6	28004774	840/359	-	5,655 lm	700 mA	44.4 V	48.1 V	-	-	174 lm/W	>80
LLE 24x560mm 2400lm 840 HV ADV6 BT	28004775	840/359	-	5,655 lm	700 mA	44.4 V	48.1 V	-	-	174 lm/W	>80
LLE 24x560mm 2400lm 850 HV ADV6	28004776	850/359	-	5,619 lm	700 mA	44.4 V	48.1 V	-	-	173 lm/W	>80
LLE 24x560mm 2400lm 865 HV ADV6	28004777	865/359	-	5,543 lm	700 mA	44.4 V	48.1 V	-	-	171 lm/W	>80

② If mounted with M4 screws with 7 mm head diameter.

③ The detailed explanation, see data sheet section 1.1.

④ Tolerance of useful light flux - 0 % / + 15 %. Measurement uncertainty ± 10 %.

⑤ Tolerance of expected light flux - 0 % / + 15 %. Measurement uncertainty ± 10 %. Based on calculation.

⑥ Measurement tolerance forward voltage: ±0.1 V.

⑦ Tolerance of power consumption Pon ± 10 %. Measurement uncertainty ± 5 %.

LINEAR COVER LLE

Accessory

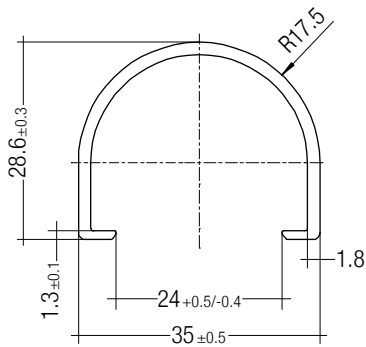

Product description

- _ LINEAR COVER for LLE
- _ Protection against direct touch for non-SELV applications (recommendation LLE 20: use all fixing points and screwed Endcap, recommendation LLE 24: use all fixing points)
- _ Fast snap on mounting on to LLE 20: with M4 screws and plastic washers, to LLE 24: with clips or plastic washers
- _ High transmission: transparent, semi-transparent and diffuse
- _ Material: PMMA
- _ Tolerances: ± 1 mm for 597 mm length (ends finished), + 10 mm from length 1,150 mm (ends raw)

Website

<http://www.tridonic.com/28000338>



Ordering data

Type	Article number	Colour	Length L	Efficiency	Packaging, carton	Weight per pc.
LINEAR COVER SY Transparent 1600mm	28000338	Transparent	1,600 mm	94 %	12 pc(s).	0.272 kg
LINEAR COVER SY Frosted 1800mm	28000437	Semi-transparent	1,800 mm	87 %	12 pc(s).	0.308 kg
LINEAR COVER SY Frosted 1600mm	28000339	Semi-transparent	1,600 mm	87 %	12 pc(s).	0.272 kg
LINEAR COVER SY Frosted 1500mm	28000435	Semi-transparent	1,500 mm	87 %	12 pc(s).	0.244 kg
LINEAR COVER SY Frosted 1200mm	28000422	Semi-transparent	1,200 mm	87 %	12 pc(s).	0.205 kg
LINEAR COVER SY Frosted 597mm	28000340	Semi-transparent	597 mm	87 %	12 pc(s).	0.102 kg
LINEAR COVER SY Diffuse 1800mm	28000438	Diffuse	1,800 mm	76 %	12 pc(s).	0.308 kg
LINEAR COVER SY Diffuse 1600mm	28000341	Diffuse	1,600 mm	76 %	12 pc(s).	0.272 kg
LINEAR COVER SY Diffuse 1500mm	28000436	Diffuse	1,500 mm	76 %	12 pc(s).	0.257 kg
LINEAR COVER SY Diffuse 1200mm	28000434	Diffuse	1,200 mm	76 %	12 pc(s).	0.205 kg
LINEAR COVER SY Diffuse 597mm	28000342	Diffuse	597 mm	76 %	12 pc(s).	0.102 kg

ACL ENDCAP LLE

Accessory

**Product description**

- _ ENDCAP for LLE
- _ PUSH-FIX: Fast snap on mounting (sheet thickness 0.5 – 1.0 mm), for drilling hole 4 mm
- _ SCREW-FIX: Screw mounting with EJOT Delta PT WN 5451 30x8 (not included), tightening torque 0.7 Nm
- _ Clip made of polycarbonate

Website

<http://www.tridonic.com/28001037>

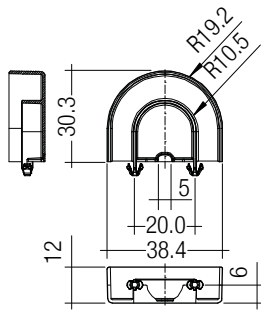
**Ordering data**

Type	Article number	Colour	Packaging, carton	Weight per pc.
ACL ENDCAP LLE24 PUSH-FIX	28001037	White	480 pc(s).	0.003 kg
ACL ENDCAP LLE24 SCREW-FIX	28002315	White	480 pc(s).	0.003 kg

ACL LINEAR LENS 24mm

Accessory

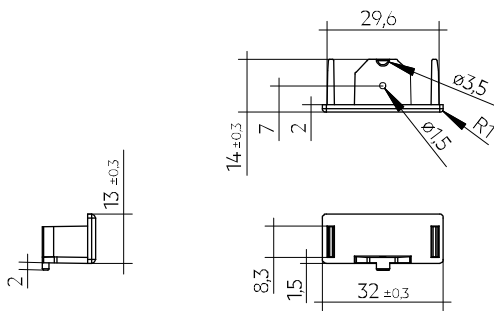
**Product description LINEAR LENS**

- _ Linear lens for LLE 20 / 24
- _ Available with different beam characteristics
- _ Protection against direct touch for non-SELV applications (recommendation: use all fixing points)
- _ Fast snap on mounting on to LLE 20: with M4 screws and plastic washers, to LLE 24: with clips or plastic washers
- _ Recommendation: Fastening with screws and plastic washers, see 2.3 Heat sink specifications in data sheet
- _ Material: PMMA
- _ Available lengths: 1,200, 1,500 and 1,800 mm, Tolerance: + 10 mm (ends raw)
- _ Max. permissible temperature 80 °C
- _ Photometric data available on website

Product description Endcap

- _ ENDCAP for LINEAR LENS 24mm INTENSE, ASY and DASY
- _ Mounting by clipping in and screwing from below using screw EJOT Delta PT WN 5451 20x4, tightening torque 0.7 Nm
- _ Made of Polyamide UL94 V0

Website

<http://www.tridonic.com/28001428>

**Ordering data**

Type	Article number	Length L	Beam characteristic	Efficiency	Packaging, carton	Weight per pc.
ACL LINEAR LENS 24x1200mm 60°	28001428	1,200 mm	60°	97 %	21 pc(s).	0.196 kg
ACL LINEAR LENS 24x1200mm 90°	28001429	1,200 mm	90°	97 %	21 pc(s).	0.165 kg
ACL LINEAR LENS 24x1500mm 60°	28000953	1,500 mm	60°	97 %	21 pc(s).	0.261 kg
ACL LINEAR LENS 24x1500mm 90°	28000955	1,500 mm	90°	97 %	21 pc(s).	0.221 kg
ACL LINEAR LENS 24x1200mm INTENSE	28002024	1,200 mm	40°	95 %	18 pc(s).	0.261 kg
ACL LINEAR LENS 24x1500mm INTENSE	28002025	1,500 mm	40°	95 %	18 pc(s).	0.326 kg
ACL LINEAR LENS 24x1800mm INTENSE	28002026	1,800 mm	40°	95 %	18 pc(s).	0.392 kg
ACL LINEAR LENS 24x1200mm BATWING	28002027	1,200 mm	batwing	95 %	18 pc(s).	0.275 kg
ACL LINEAR LENS 24x1500mm BATWING	28002028	1,500 mm	batwing	95 %	18 pc(s).	0.344 kg
ACL LINEAR LENS 24x1800mm BATWING	28002029	1,800 mm	batwing	95 %	18 pc(s).	0.412 kg
ACL LINEAR LENS 24x1200mm ASY	28002030	1,200 mm	asymmetric	95 %	18 pc(s).	0.250 kg
ACL LINEAR LENS 24x1500mm ASY	28002031	1,500 mm	asymmetric	95 %	18 pc(s).	0.312 kg
ACL LINEAR LENS 24x1800mm ASY	28002032	1,800 mm	asymmetric	95 %	18 pc(s).	0.375 kg
ACL LINEAR LENS 24x1200mm DASY	28002033	1,200 mm	double asymmetric	92 %	18 pc(s).	0.249 kg
ACL LINEAR LENS 24x1500mm DASY	28002034	1,500 mm	double asymmetric	92 %	18 pc(s).	0.311 kg
ACL LINEAR LENS 24x1800mm DASY	28002035	1,800 mm	double asymmetric	92 %	18 pc(s).	0.373 kg
ACL Endcap LENS 24mm PSF	28002669	-	-	-	3,600 pc(s).	0.003 kg

ACL CLIP 4.3mm

Accessory

**Product description**

- _ Clip for fixation of LED modules with 4.3 mm holes
- _ Fast snap on mounting (sheet thickness 0.5 – 1.0 mm for PUSH-FIX and 1 – 2 mm for PUSH-FIX Long)
- _ For drilling hole 4 mm
- _ Clip made of polycarbonate
- _ Minimum sales quantity 500 pcs.

Website

<http://www.tridonic.com/28001036>

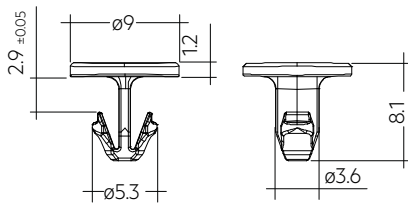
**Ordering data**

Type	Article number	Colour	Packaging, bag ^①	Weight per pc.
ACL CLIP 4.3mm PUSH-FIX	28001036	White	500 pc(s).	0.001 kg
ACL CLIP 4,3mm PUSH-FIX Long	28002314	Transparent	500 pc(s).	0.001 kg

① Minimum sales quantity 500 pcs.

ACL BRIDGE LLE24/40

Accessory

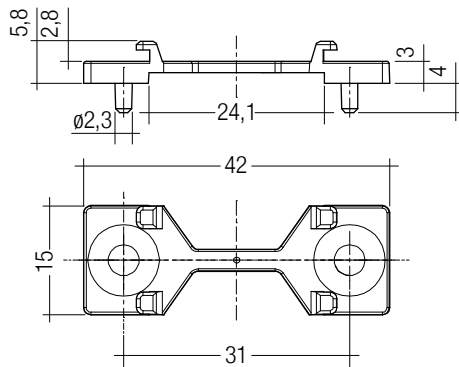
**Product description**

- _ Enables the fixation of 24 mm wide Tridonic LED modules to fixtures made for 40 mm wide modules
- _ Ideal for extruded aluminium gear trays made for 40 mm modules with pre-alignment knobs
- _ Clip-on for LINEAR COVER and LINEAR LENS ^①
- _ For LLE 24 with 280 mm module minimum 2 bridges required
- _ For LLE 24 with 560 mm module minimum 3 bridges required
- _ Fixation via M3 or M4 countersunk screw, max. tightening torque 0.5 Nm
- _ Material: white polycarbonate
- _ Minimum sales quantity 600 pcs.

^① Beam characteristics will change due to the elevated fixation (see photometric files for details).

Website

<http://www.tridonic.com/28001205>

**Ordering data**

Type	Article number	Colour	Packaging, carton	Weight per pc.
ACL BRIDGE LLE24/40 SCREW-FIX	28001205	White	600 pc(s).	0.001 kg

1. Standards

IEC 62031
IEC 62471
IEC 61000-4-2
IEC 62778
IEC 61547

1.1 Photometric code

Key for photometric code, e. g. 830 / 349

1 st digit	2 nd + 3 rd digit	4 th digit	5 th digit	6 th digit	
Code	Colour temperature in Kelvin x 100	MacAdam initial	MacAdam after 25% of the lifetime (max.6000h)	Luminous flux after 25% of the lifetime (max.6000h)	
CRI				Code	Luminous flux
7 70 – 79				7	≥ 70 %
8 80 – 89				8	≥ 80 %
9 ≥90			9	≥ 90 %	

1.2 Risk group

Forward current	Risk group (IEC 62471)
≤ 280 mA	RG0
> 280 – 800 mA (Imax)	RG1

1.3 Energy classification

Type	Colour temperature	Forward current	Energy classification	Energy consumption
LLE 24x70mm 325lm 827 HV ADV6 QTY4	2,700 K	275 mA	C	2 kWh / 1,000 h
LLE 24x70mm 325lm 830 HV ADV6 QTY4	3,000 K	275 mA	C	2 kWh / 1,000 h
LLE 24x70mm 325lm 835 HV ADV6 QTY4	3,500 K	275 mA	C	2 kWh / 1,000 h
LLE 24x70mm 325lm 840 HV ADV6 QTY4	4,000 K	275 mA	B	2 kWh / 1,000 h
LLE 24x70mm 325lm 850 HV ADV6 QTY4	5,000 K	275 mA	B	2 kWh / 1,000 h
LLE 24x70mm 325lm 865 HV ADV6 QTY4	6,500 K	275 mA	B	2 kWh / 1,000 h
LLE 24x140mm 650lm 827 HV ADV6	2,700 K	275 mA	C	4 kWh / 1,000 h
LLE 24x140mm 650lm 830 HV ADV6	3,000 K	275 mA	C	4 kWh / 1,000 h
LLE 24x140mm 650lm 835 HV ADV6	3,500 K	275 mA	B	4 kWh / 1,000 h
LLE 24x140mm 650lm 840 HV ADV6	4,000 K	275 mA	B	4 kWh / 1,000 h
LLE 24x140mm 650lm 850 HV ADV6	5,000 K	275 mA	B	4 kWh / 1,000 h
LLE 24x140mm 650lm 865 HV ADV6	6,500 K	275 mA	B	4 kWh / 1,000 h
LLE 24x280mm 1250lm 827 HV ADV6	2,700 K	275 mA	C	7 kWh / 1,000 h
LLE 24x280mm 1250lm 830 HV ADV6	3,000 K	275 mA	C	7 kWh / 1,000 h
LLE 24x280mm 1250lm 835 HV ADV6	3,500 K	275 mA	C	7 kWh / 1,000 h
LLE 24x280mm 1250lm 840 HV ADV6	4,000 K	275 mA	B	7 kWh / 1,000 h
LLE 24x280mm 1250lm 840 HV ADV6 BT	4,000 K	275 mA	B	7 kWh / 1,000 h
LLE 24x280mm 1250lm 850 HV ADV6	5,000 K	275 mA	B	7 kWh / 1,000 h
LLE 24x280mm 1250lm 865 HV ADV6	6,500 K	275 mA	B	7 kWh / 1,000 h
LLE 24x560mm 2400lm 827 HV ADV6	2,700 K	275 mA	C	13 kWh / 1,000 h
LLE 24x560mm 2400lm 830 HV ADV6	3,000 K	275 mA	C	13 kWh / 1,000 h
LLE 24x560mm 2400lm 835 HV ADV6	3,500 K	275 mA	C	13 kWh / 1,000 h
LLE 24x560mm 2400lm 840 HV ADV6	4,000 K	275 mA	B	13 kWh / 1,000 h
LLE 24x560mm 2400lm 840 HV ADV6 BT	4,000 K	275 mA	B	13 kWh / 1,000 h
LLE 24x560mm 2400lm 850 HV ADV6	5,000 K	275 mA	B	13 kWh / 1,000 h
LLE 24x560mm 2400lm 865 HV ADV6	6,500 K	275 mA	B	13 kWh / 1,000 h

Energy label and further information at www.tridonic.com in the certificates tab of the corresponding product page and at the EPREL data base <https://eprel.ec.europa.eu/>

2. Thermal details

2.1 tc point, ambient temperature and lifetime

The temperature at tp reference point is crucial for the light output and lifetime of a LED product.

For LLE a tp temperature of 50 °C has to be complied in order to achieve an optimum between heat sink requirements, light output and lifetime.

Compliance with the maximum permissible reference temperature at the tc point must be checked under operating conditions in a thermally stable state. The maximum value must be determined under worst-case conditions for the relevant application.

The tc and tp temperature of LED modules from Tridonic are measured at the same reference point.

2.2 Storage and humidity

Storage temperature	-40... +80 °C
---------------------	---------------

Operation only in non condensing environment.

Humidity during processing of the module should be between 30 to 70 %.

2.3 Heat sink values

LLE 24x70mm 325lm ADV6

ta	tp	Forward current	R _{th, hs-a}	Cooling area
25 °C	50 °C	275 mA	3397 K/W	20 cm ²
25 °C	50 °C	700 mA	8.46 K/W	79 cm ²
35 °C	50 °C	275 mA	19.24 K/W	35 cm ²
35 °C	50 °C	700 mA	3.93 K/W	169 cm ²
40 °C	50 °C	275 mA	11.87 K/W	56 cm ²
40 °C	50 °C	700 mA	1.67 K/W	399 cm ²
45 °C	50 °C	275 mA	4.51 K/W	148 cm ²
45 °C	50 °C	700 mA	–	–

LLE 24x140mm 650lm ADV6

ta	tp	Forward current	R _{th, hs-a}	Cooling area
25 °C	50 °C	275 mA	16.98 K/W	39 cm ²
25 °C	50 °C	700 mA	4.23 K/W	158 cm ²
35 °C	50 °C	275 mA	9.62 K/W	69 cm ²
35 °C	50 °C	700 mA	1.97 K/W	339 cm ²
40 °C	50 °C	275 mA	5.94 K/W	112 cm ²
40 °C	50 °C	700 mA	0.84 K/W	798 cm ²
45 °C	50 °C	275 mA	2.25 K/W	296 cm ²
45 °C	50 °C	700 mA	–	–

LLE 24x280mm 1250lm ADV6

ta	tp	Forward current	R _{th, hs-a}	Cooling area
25 °C	50 °C	275 mA	8.49 K/W	79 cm ²
25 °C	50 °C	700 mA	2.12 K/W	315 cm ²
35 °C	50 °C	275 mA	4.81 K/W	139 cm ²
35 °C	50 °C	700 mA	0.98 K/W	678 cm ²
40 °C	50 °C	275 mA	2.97 K/W	225 cm ²
40 °C	50 °C	700 mA	0.42 K/W	1,596 cm ²
45 °C	50 °C	275 mA	1.13 K/W	592 cm ²
45 °C	50 °C	700 mA	–	–

LLE 24x560mm 2400lm ADV6

ta	tp	Forward current	R _{th, hs-a}	Cooling area
25 °C	50 °C	275 mA	4.25 K/W	157 cm ²
25 °C	50 °C	700 mA	1.06 K/W	630 cm ²
35 °C	50 °C	275 mA	2.40 K/W	277 cm ²
35 °C	50 °C	700 mA	0.49 K/W	1,356 cm ²
40 °C	50 °C	275 mA	1.48 K/W	449 cm ²
40 °C	50 °C	700 mA	0.21 K/W	3,192 cm ²
45 °C	50 °C	275 mA	0.56 K/W	1,183 cm ²
45 °C	50 °C	700 mA	–	–

Notes

The actual cooling surface can differ because of the material, the structural shape, outside influences and the installation situation. Depending on the heat sink a heat conducting paste or heat conducting film might be necessary to keep the specified tp temperature.

For applications with a small distance between LED module and lens, screw mounting is recommended to ensure a reliable thermal connection between LED module and cooling surface.

3. Installation / wiring

3.1 Electrical supply/choice of LED driver

LLE modules from Tridonic are not protected against overvoltages, overcurrents, overloads or short-circuit currents. Safe and reliable operation can only be guaranteed in conjunction with a LED driver which complies with the relevant standards. The use of LED driver from Tridonic in combination with LLE modules guarantees the necessary protection for safe and reliable operation.

If a LED driver other than Tridonic is used, it must provide the following protection:

- Short-circuit protection
- Overload protection
- Overtemperature protection



LLE modules must be supplied by a constant current LED driver. Operation with a constant voltage LED driver will lead to an irreversible damage of the module.

Wrong polarity can damage the LLE.

The LLE module is designed for serial wiring.

With parallel wiring tolerance-related differences in output are possible (thermal stress of the module) and can cause differences in brightness.

If a wire breaks or a complete module fails then the current passing through the other module increases. This may reduce its life considerably.

Max. 8 pieces 280 mm modules or 4 pieces 560 mm modules may be connected in parallel.

The max. permissible output current of the LED driver for parallel wiring is 1.8 A. For applications with a small distance between LED module and lens, an output current of 1.35 A must not be exceeded.

LLE can be operated either from SELV LED drivers or from LED drivers with LV output voltage.



LLE are basic insulated up to 440 V (if mounted with M4 screws with head diameter 7 mm) against ground and can be mounted directly on earthed metal parts of the luminaire. If the max. output voltage of the LED driver (also against earth) is above 440 V, an additional insulation between LED module and heat sink is required (for example by insulated thermal pads) or by a suitable luminaire construction.

At voltages > 60 V an additional protection against direct touch (test finger) to the light emitting side of the module has to be guaranteed. This is typically achieved by means of a non removable light distributor over the module.

3.2 Wiring

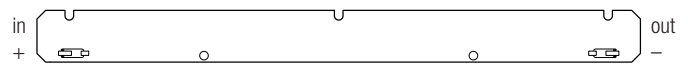

Wiring examples for serial wiring

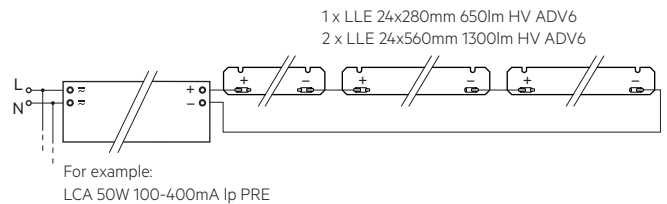
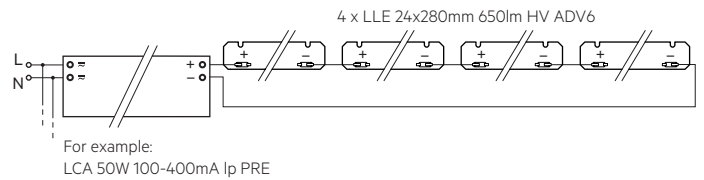

Wiring examples for parallel wiring

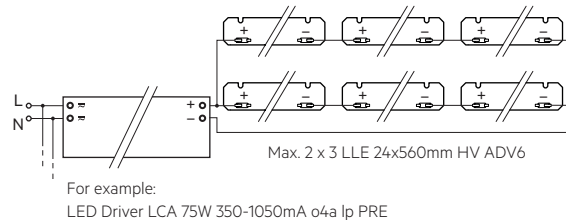
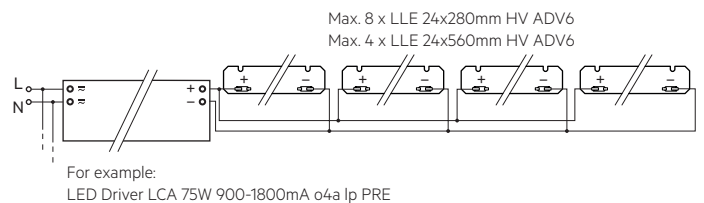

3.3 Wiring type and cross section

For wiring use stranded wire with ferrules or solid wire from 0.2 to 0.75 mm². For the push-wire connection you have to strip the insulation (8–9 mm).

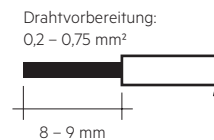

To remove the wires use a suitable tool (e.g. Microcon release pin) or through twist and pull.

3.4 Mounting instruction



None of the components of the LLE (substrate, LED, electronic components etc.) may be exposed to tensile or compressive stresses.

Max. torque for fixing: 0.5 Nm.

The LED modules are mounted onto a heat sink with min. 3 screws per module or ACL CLIP 4.3mm.

The LLE 24x70mm module is delivered as a board of 280mm (4 pcs.) and must be separated.

Only touch the module at the edge to separate the modules (see marking below).

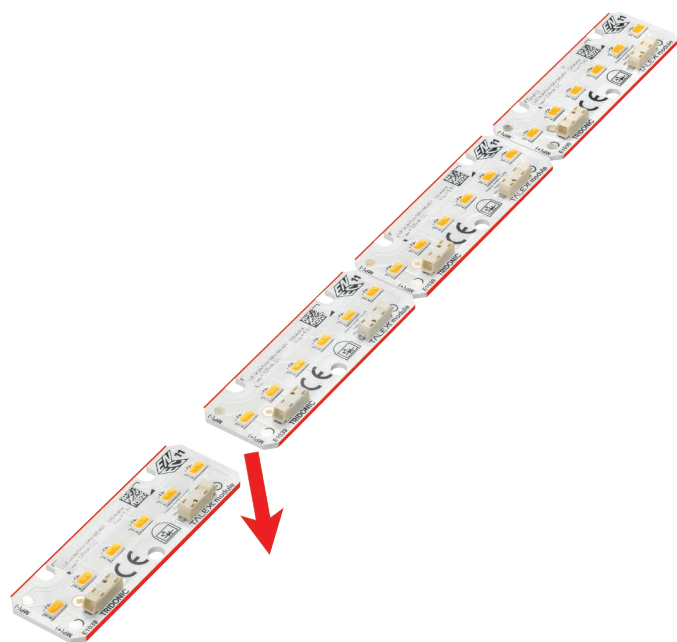

Cut out on gear tray for backside terminal:

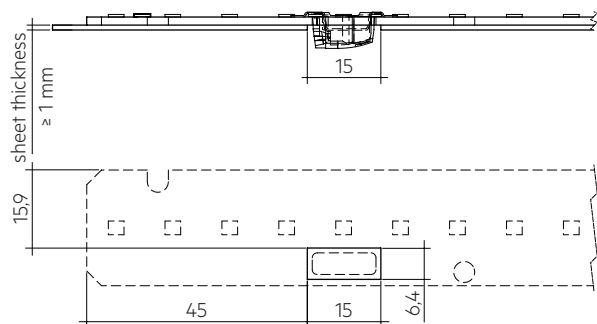

The distance between the terminal and the luminaire sheet must be at least 12 mm.



Chemical substance may harm the LED module. Chemical reactions could lead to colour shift, reduced luminous flux or a total failure of the module caused by corrosion of electrical connections.

Materials which are used in LED applications (e.g. sealings, adhesives) must not produce dissolver gas. They must not be condensation curing based, acetate curing based or contain sulfur, chlorine or phthalate.

Avoid corrosive atmosphere during usage and storage.

3.5 EOS/ESD safety guidelines



The device / module contains components that are sensitive to electrostatic discharge and may only be installed in the factory and on site if appropriate EOS/ESD protection measures have been taken. No special measures need be taken for devices/modules with enclosed casings (contact with the pc board not possible), just normal installation practice. Please note the requirements set out in the document EOS / ESD guidelines (Guideline_EOS_ESD.pdf) at: <http://www.tridonic.com/esd-protection>

4. Lifetime

4.1 Lifetime, lumen maintenance and failure rate

The light output of an LED module decreases over the lifetime, this is characterized with the L value.
L70 means that the LED module will give 70 % of its initial luminous flux.
This value is always related to the number of operation hours and therefore defines the lifetime of an LED module.

As the L value is a statistical value and the lumen maintenance may vary over the delivered LED modules.

The B value defines the amount of modules which are below the specific L value, e.g. L70B10 means 10 % of the LED modules are below 70 % of the initial luminous flux, respectively 90 % will be above 70 % of the initial value.
In addition the percentage of failed modules (fatal failure) is characterized by the C value.

4.2 Lumen maintenance for LLE 24mm HV ADV6

Forward current	tp	L90 / B10	L90 / B50	L80 / B10	L80 / B50	L70 / B10	L70 / B50
	tempera- ture						
700 mA	55 °C	52k h	52k h	> 102k h	> 102k h	> 102k h	> 102k h
	85 °C	52k h	52k h	> 102k h	> 102k h	> 102k h	> 102k h

L00C03 > 102k h. At tp rated and I rated, based on 10 swichting cycles per day.

4.3 Switching capability

100,000 cycles

Tridonic test according to IEC 62717 Cl 10.3.3
30 s on / 30 s off at a forward current of 195 mA

5. Electrical values

5.1 Declaration of electrical parameters

Irated ... Nominal operating current the module is designed for.

I_{max} ... Max. permissible continuous operating current incl. The tolerances of the LED driver.

Max. permissible LF current ripple ... Max. output current of the LED driver incl. Tolerances and LF current ripple must not exceed this value.

Max. permissible peak current ... The max. output peak current of the LED driver must not exceed this value.

5.2 Typ. forward voltage vs. forward current

LLE 24x70mm 325lm 8xx HV ADV6

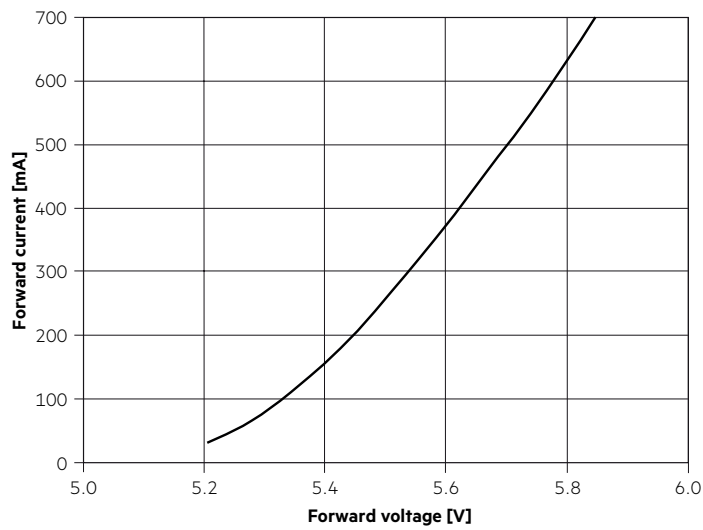

LLE 24x140mm 650lm 8xx HV ADV6

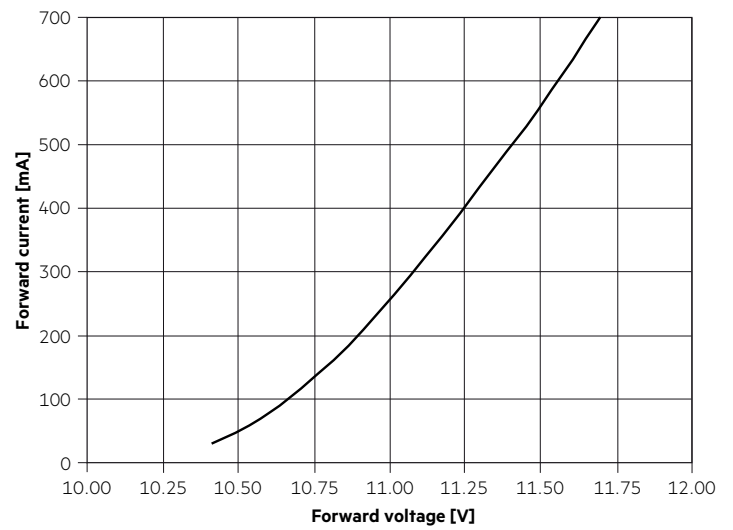

LLE 24x280mm 1250lm 8xx HV ADV6

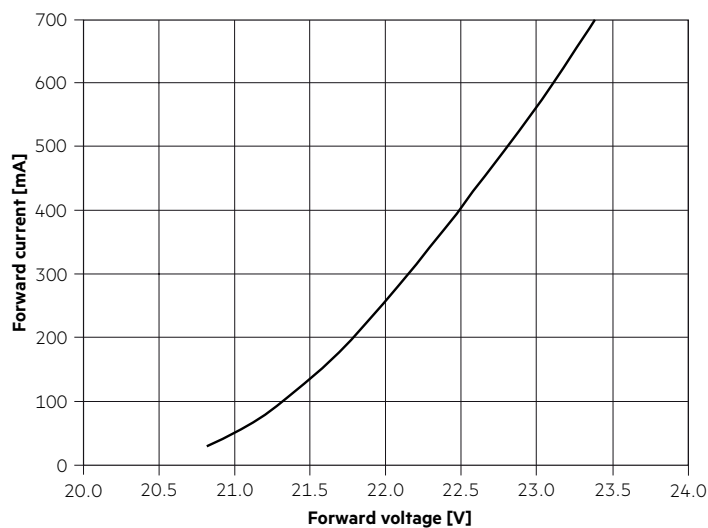

LLE 24x560mm 2400lm 8xx HV ADV6

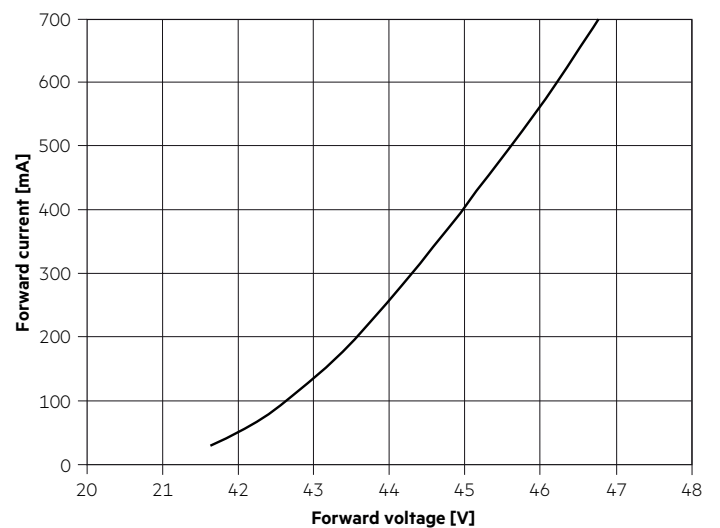

The diagrams are based on statistic values.
The real values can be different.

5.3 Forward voltage vs. tc temperature

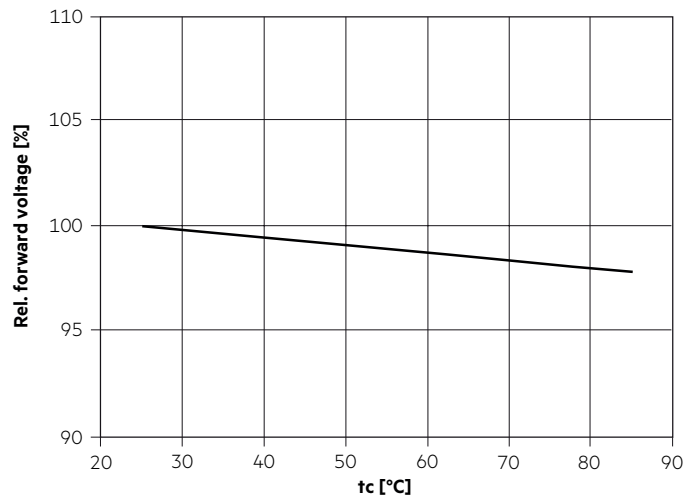

The diagrams are based on statistic values.
The real values can be different.

6. Photometric characteristics

6.1 Coordinates and tolerances according to CIE 1931

The specified colour coordinates are integral measured by current impulse of 195 mA and a duration of 100 ms.

The ambient temperature of the measurement is $t_a = 25^\circ\text{C}$.

The measurement tolerance of the colour coordinates are ± 0.01 .

2,700 K

	x0	y0
Centre	0.4578	0.4101

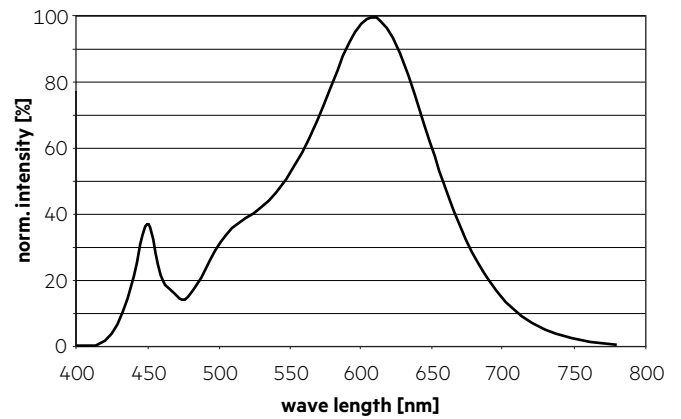
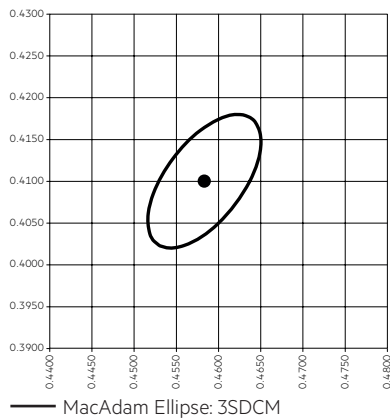

3,000 K

	x0	y0
Centre	0.4338	0.4030

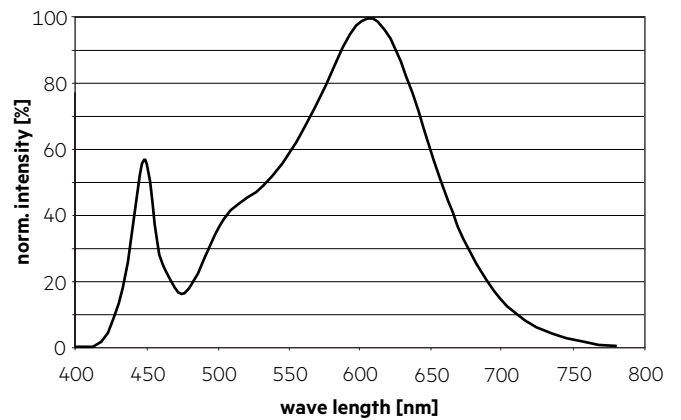
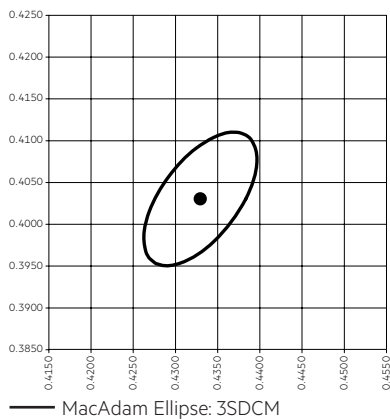

3,500 K

	x0	y0
Centre	0.4073	0.3917

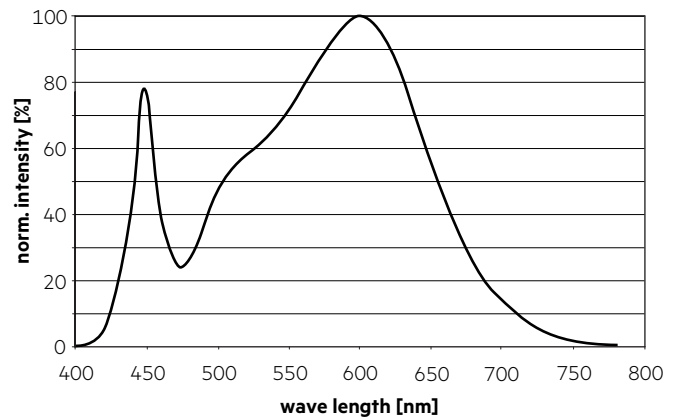
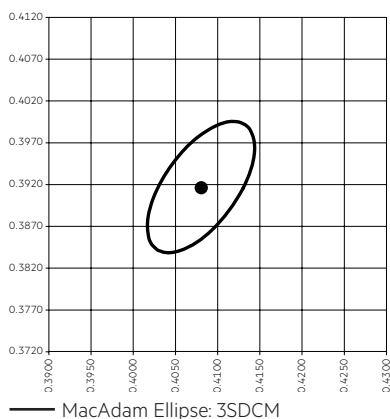

4,000 K

	x0	y0
Center	0.3818	0.3797

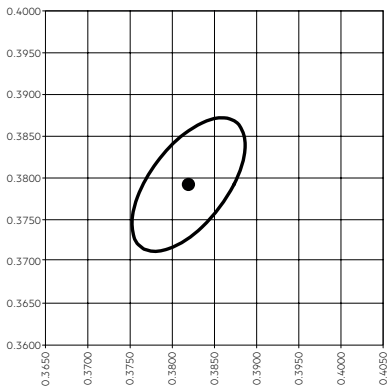

— MacAdam Ellipse: 3SDCM

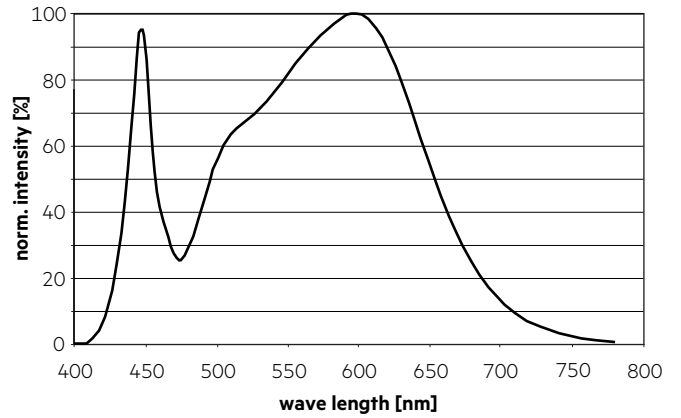

5,000 K

	x0	y0
Center	0.3447	0.3553

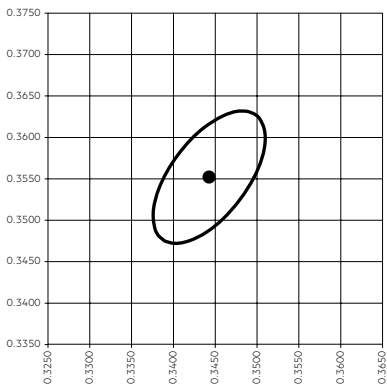

— MacAdam Ellipse: 3SDCM

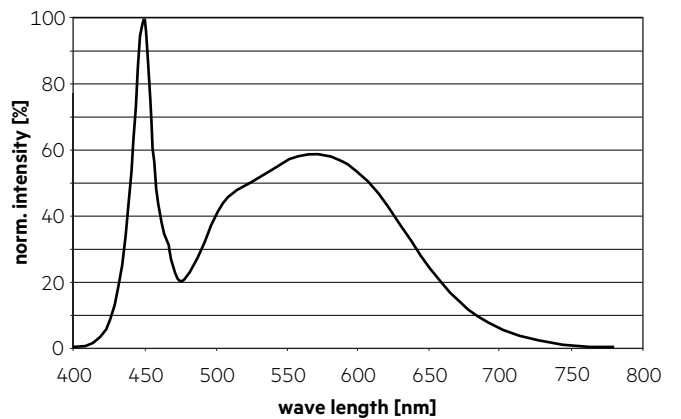

6,500 K

	x0	y0
Center	0.3123	0.3282

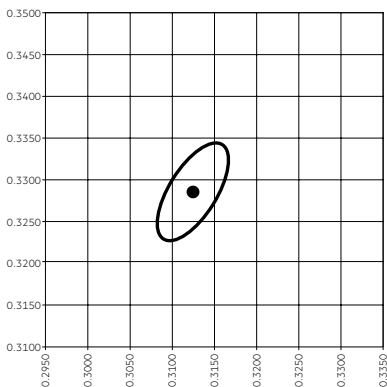

— MacAdam Ellipse: 3SDCM

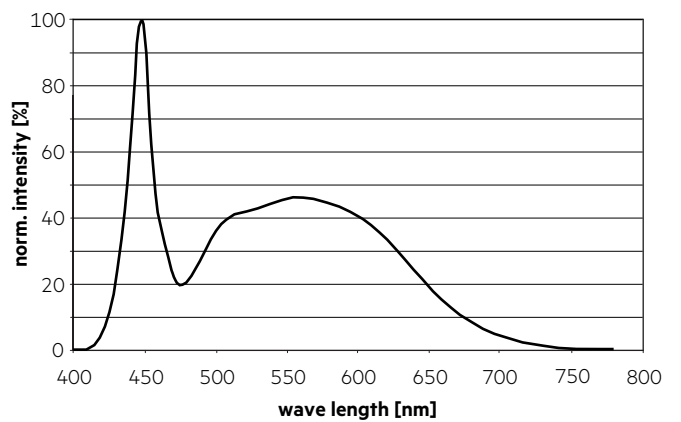

6.2 Light distribution

The optical design of the LLE product line ensures optimum homogeneity for the light distribution.

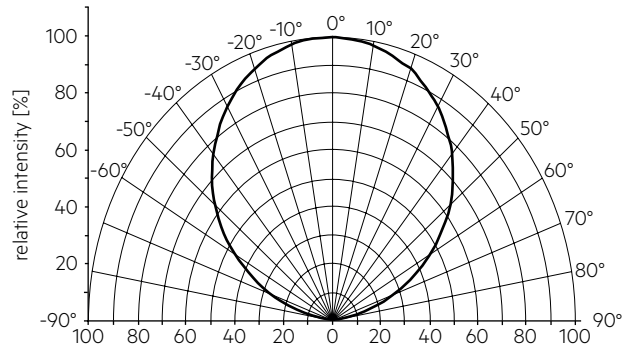

The colour temperature is measured integral over the complete module. The single LED light points can have deviations in the colour coordinates within MacAdam 5. To ensure an ideal mixture of colours and a homogeneous light distribution a suitable optic (e. g. PMMA diffuser) and a sufficient spacing between module and optic (typ. 4 cm) should be used.

6.3 Relative luminous flux vs. tc temperature

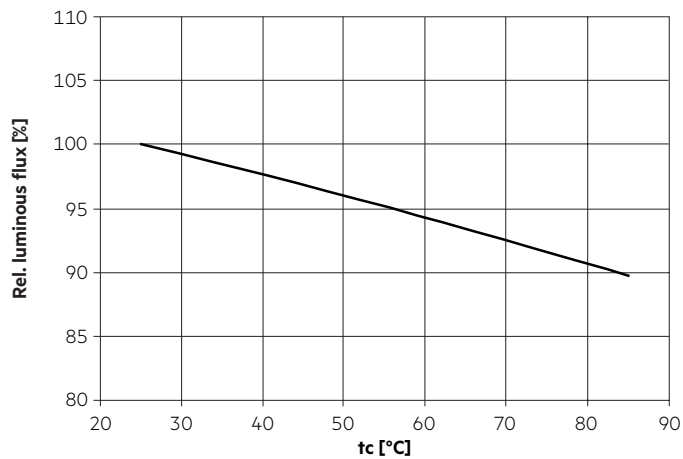

6.4 Relative luminous flux vs. operating current

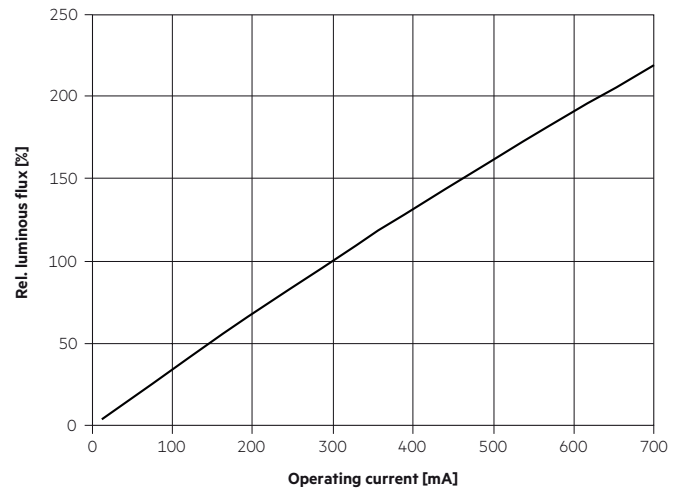

The diagrams are based on statistic values. The real values can be different.

7. Miscellaneous

7.1 Additional information

Additional technical information at www.tridonic.com → Technical Data

Energy label and further information at www.tridonic.com in the certificates tab of the corresponding product page and at the EPREL data base <https://eprel.ec.europa.eu/>

Guarantee conditions at www.tridonic.com → Services

Lifetime declarations are informative and represent no warranty claim.