

**Module LLE 20x280-560mm 650lm LV SNC4**

Modules LLE essence



LLE 20x280mm 650lm LV SNC4



LLE 20x560mm 1300lm LV SNC4

**Product description**

- \_ Ideal for linear and panel lights
- \_ 4 terminals for parallel wiring
- \_ Push terminals for quick and simple wiring of LED module to LED module
- \_ HE ... High Efficiency, NM ... Nominal Mode, HO ... High Output
- \_ Long lifetime up to 72,000 hours (for details 4.2 Lumen maintenance)
- \_ 5 years guarantee (conditions at <https://www.tridonic.com/en/int/services/manufacturer-guarantee-conditions>)

**Optical properties**

- \_ Colour temperatures 3,000 and 4,000 K
- \_ Efficacy of the LED module up to 188 lm/W
- \_ High colour rendering index CRI > 80
- \_ Small colour tolerance (MacAdam 3) <sup>①</sup>
- \_ Small luminous flux tolerances

**Mechanical properties**

- \_ Module dimension 20 x 280 mm and 20 x 560 mm
- \_ Simple installation (e.g. screws)

<sup>①</sup> Integral measurement over the complete module.

**Website**

<http://www.tridonic.com/28005452>

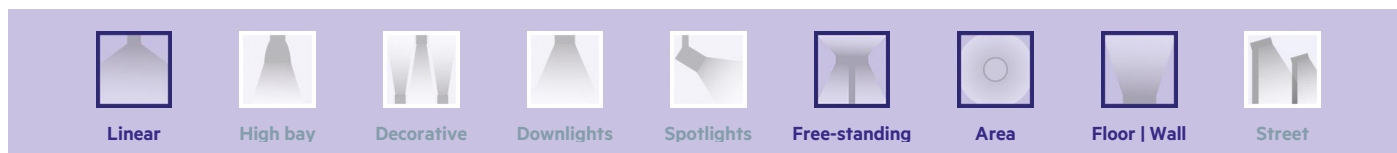
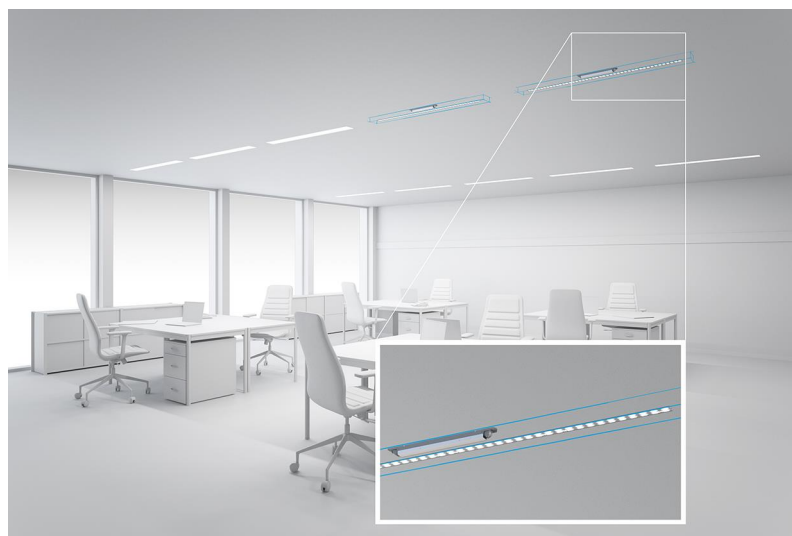

**Module LLE 20x280-560mm 650lm LV SNC4**

Modules LLE essence

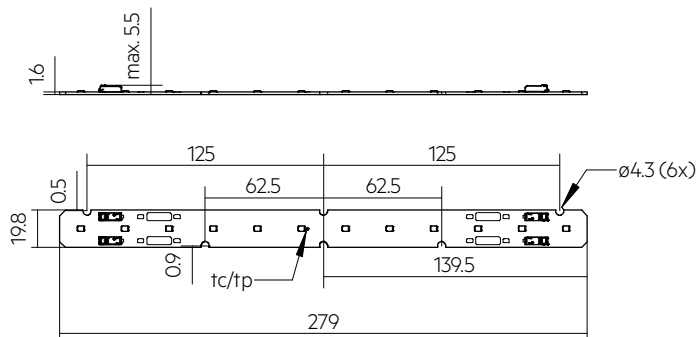

LLE 20x280mm 650lm LV SNC4

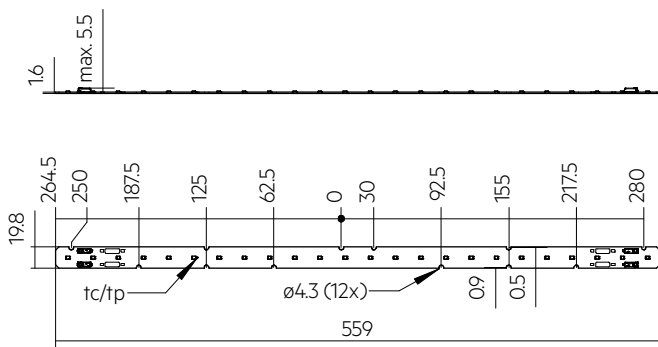

LLE 20x560mm 1300lm LV SNC4

**Ordering data**

Type	Article number	Colour temperature	Packaging, carton	Weight per pc.
LLE 20x280mm 650lm 830 LV SNC4	28005452	3,000 K	108 pc(s).	0.015 kg
LLE 20x280mm 650lm 840 LV SNC4	28005453	4,000 K	108 pc(s).	0.015 kg
LLE 20x560mm 1300lm 830 LV SNC4	28005456	3,000 K	108 pc(s).	0.030 kg
LLE 20x560mm 1300lm 840 LV SNC4	28005457	4,000 K	108 pc(s).	0.030 kg

**Technical data**

Beam characteristic	120°
Ambient temperature $t_a$	-40 ... +65 °C
$t_p$ rated	50 °C
$t_c$	90 °C
Irated for 650 lm	100 mA
Irated for 1,300 lm	200 mA
I <sub>max</sub> for 650 lm	200 mA
I <sub>max</sub> for 1,300 lm	400 mA
Max. permissible LF current ripple for 650 lm	220 mA
Max. permissible LF current ripple for 1,300 lm	440 mA
Max. permissible peak current for 650 lm	300 mA / max. 10 ms
Max. permissible peak current for 1,300 lm	600 mA / max. 10 ms
Max. working voltage for insulation SELV	< 60 V
Insulation test voltage	0.5 kV
Colour tolerance <sup>①</sup>	3 SDCM
ESD classification	Severity level 2
Risk group (IEC 62471)	RG1
Classification acc. to IEC 62031	Built-in
Type of protection	IPO0
Lumen maintenance L70B50	72,000 h
Guarantee (conditions at www.tridonic.com)	5 Year(s)

**Approval marks****Standards**

IEC 62031, IEC 62471, IEC 61000-4-2, IEC 62778, IEC 61547

**Specific technical data**

Type	Article number	Photometric code	Useful luminous flux at $t_p = 25\text{ °C}$ <sup>②</sup>	Expected luminous flux at $t_p$ rated <sup>③</sup>	Typ. forward current	Min. forward voltage at $t_p$ rated	Max. forward voltage at $t_p = 25\text{ °C}$	Power consumption $P_{on}$ at $t_p = 25\text{ °C}$ <sup>④</sup>	Efficacy of the module at $t_p = 25\text{ °C}$	Expected efficacy of the module at $t_p$ rated	Colour rendering index CRI
<b>Operating mode HE</b>											
LLE 20x280mm 650lm 830 LV SNC4	28005452	830/359	-	307 lm	50 mA	30.7 V	34.2 V	-	-	190 lm/W	>80
LLE 20x280mm 650lm 840 LV SNC4	28005453	840/359	-	322 lm	50 mA	30.7 V	34.2 V	-	-	200 lm/W	>80
LLE 20x560mm 1300lm 830 LV SNC4	28005456	830/359	-	613 lm	100 mA	30.7 V	34.2 V	-	-	190 lm/W	>80
LLE 20x560mm 1300lm 840 LV SNC4	28005457	840/359	-	644 lm	100 mA	30.7 V	34.2 V	-	-	200 lm/W	>80
<b>Operating mode NM</b>											
LLE 20x280mm 650lm 830 LV SNC4	28005452	830/359	610 lm	589 lm	100 mA	31.8 V	35.3 V	3.4 W	179 lm/W	177 lm/W	>80
LLE 20x280mm 650lm 840 LV SNC4	28005453	840/359	640 lm	619 lm	100 mA	31.8 V	35.3 V	3.4 W	188 lm/W	186 lm/W	>80
LLE 20x560mm 1300lm 830 LV SNC4	28005456	830/359	1,220 lm	1,179 lm	200 mA	31.8 V	35.3 V	6.8 W	179 lm/W	177 lm/W	>80
LLE 20x560mm 1300lm 840 LV SNC4	28005457	840/359	1,280 lm	1,237 lm	200 mA	31.8 V	35.3 V	6.8 W	188 lm/W	186 lm/W	>80
<b>Operating mode HO</b>											
LLE 20x280mm 650lm 830 LV SNC4	28005452	840/359	-	980 lm	175 mA	33.3 V	36.9 V	-	-	161 lm/W	>80
LLE 20x280mm 650lm 840 LV SNC4	28005453	840/359	-	1,028 lm	175 mA	33.3 V	36.9 V	-	-	169 lm/W	>80
LLE 20x560mm 1300lm 830 LV SNC4	28005456	830/359	-	1,959 lm	350 mA	33.3 V	36.9 V	-	-	161 lm/W	>80
LLE 20x560mm 1300lm 840 LV SNC4	28005457	840/359	-	2,057 lm	350 mA	33.3 V	36.9 V	-	-	169 lm/W	>80

① Integral measurement over the complete module.

② Tolerance of useful light flux - 0 % / + 15 %. Measurement uncertainty ± 10 %.

③ Tolerance of expected light flux - 10 % / + 10 %. Measurement uncertainty ± 10 %. Based on calculation.

④ Tolerance of power consumption  $P_{on}$  ± 10 %. Measurement uncertainty ± 5 %.

## LINEAR COVER LLE

Accessory

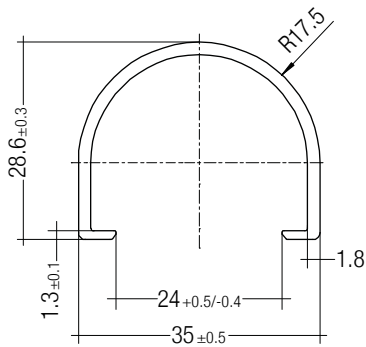

## Product description

- \_ LINEAR COVER for LLE
- \_ Protection against direct touch for non-SELV applications (recommendation LLE 20: use all fixing points and screwed Endcap, recommendation LLE 24: use all fixing points)
- \_ Fast snap on mounting on to LLE 20: with M4 screws and plastic washers, to LLE 24: with clips or plastic washers
- \_ High transmission: transparent, semi-transparent and diffuse
- \_ Material: PMMA
- \_ Tolerances:  $\pm 1$  mm for 597 mm length (ends finished), + 10 mm from length 1,150 mm (ends raw)

## Website

<http://www.tridonic.com/28000338>



## Ordering data

Type	Article number	Colour	Length L	Efficiency	Packaging, carton	Weight per pc.
LINEAR COVER SY Transparent 1600mm	28000338	Transparent	1,600 mm	94 %	12 pc(s).	0.272 kg
ACL LINEAR COVER 20x1450mm FROSTED	28004145	Semi-transparent	1,450 mm	82 %	50 pc(s).	0.343 kg
ACL LINEAR COVER 20x1150mm FROSTED	28003527	Semi-transparent	1,150 mm	82 %	50 pc(s).	0.087 kg
LINEAR COVER SY Frosted 1800mm	28000437	Semi-transparent	1,800 mm	87 %	12 pc(s).	0.308 kg
LINEAR COVER SY Frosted 1600mm	28000339	Semi-transparent	1,600 mm	87 %	12 pc(s).	0.272 kg
LINEAR COVER SY Frosted 1500mm	28000435	Semi-transparent	1,500 mm	87 %	12 pc(s).	0.244 kg
LINEAR COVER SY Frosted 1200mm	28000422	Semi-transparent	1,200 mm	87 %	12 pc(s).	0.205 kg
LINEAR COVER SY Frosted 597mm	28000340	Semi-transparent	597 mm	87 %	12 pc(s).	0.102 kg
LINEAR COVER SY Diffuse 1800mm	28000438	Diffuse	1,800 mm	76 %	12 pc(s).	0.308 kg
LINEAR COVER SY Diffuse 1600mm	28000341	Diffuse	1,600 mm	76 %	12 pc(s).	0.272 kg
LINEAR COVER SY Diffuse 1500mm	28000436	Diffuse	1,500 mm	76 %	12 pc(s).	0.257 kg
LINEAR COVER SY Diffuse 1200mm	28000434	Diffuse	1,200 mm	76 %	12 pc(s).	0.205 kg
LINEAR COVER SY Diffuse 597mm	28000342	Diffuse	597 mm	76 %	12 pc(s).	0.102 kg

## ACL ENDCAP LLE

Accessory

**Product description**

- \_ ENDCAP for LLE
- \_ PUSH-FIX: Fast snap on mounting (sheet thickness 0.5 – 1.0 mm), for drilling hole 4 mm
- \_ SCREW-FIX: Screw mounting with EJOT Delta PT WN 5451 30x8 (not included), tightening torque 0.7 Nm
- \_ Clip made of polycarbonate

**Website**

<http://www.tridonic.com/28004379>

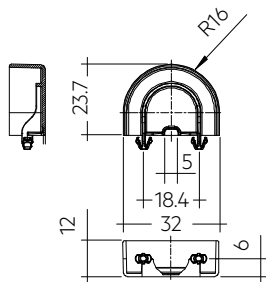
**Ordering data**

Type	Article number	Colour	Packaging, carton	Weight per pc.
ACL ENDCAP LLE20 PUSH-FIX	28004379	White	1,500 pc(s).	0.003 kg
ACL ENDCAP LLE24 PUSH-FIX	28001037	White	480 pc(s).	0.003 kg
ACL ENDCAP LLE24 SCREW-FIX	28002315	White	480 pc(s).	0.003 kg

## ACL LINEAR LENS 24mm

Accessory

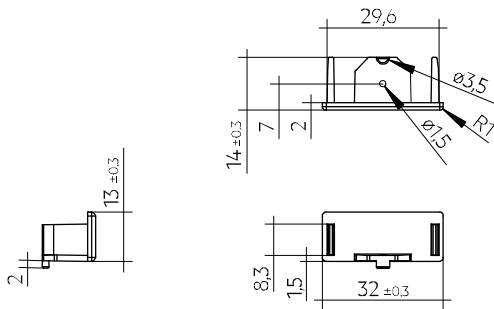
**Product description LINEAR LENS**

- \_ Linear lens for LLE 20 / 24
- \_ Available with different beam characteristics
- \_ Protection against direct touch for non-SELV applications (recommendation: use all fixing points)
- \_ Fast snap on mounting on to LLE 20: with M4 screws and plastic washers, to LLE 24: with clips or plastic washers
- \_ Recommendation: Fastening with screws and plastic washers, see 2.3 Heat sink specifications in data sheet
- \_ Material: PMMA
- \_ Available lengths: 1,200, 1,500 and 1,800 mm, Tolerance: + 10 mm (ends raw)
- \_ Max. permissible temperature 80 °C
- \_ Photometric data available on website

**Product description Endcap**

- \_ ENDCAP for LINEAR LENS 24mm INTENSE, ASY and DASY
- \_ Mounting by clipping in and screwing from below using screw EJOT Delta PT WN 5451 20x4, tightening torque 0.7 Nm
- \_ Made of Polyamide UL94 V0

**Website**

<http://www.tridonic.com/28001428>

**Ordering data**

Type	Article number	Length L	Beam characteristic	Efficiency	Packaging, carton	Weight per pc.
ACL LINEAR LENS 24x1200mm 60°	28001428	1,200 mm	60°	97 %	21 pc(s).	0.196 kg
ACL LINEAR LENS 24x1200mm 90°	28001429	1,200 mm	90°	97 %	21 pc(s).	0.165 kg
ACL LINEAR LENS 24x1500mm 60°	28000953	1,500 mm	60°	97 %	21 pc(s).	0.261 kg
ACL LINEAR LENS 24x1500mm 90°	28000955	1,500 mm	90°	97 %	21 pc(s).	0.221 kg
ACL LINEAR LENS 24x1200mm INTENSE	28002024	1,200 mm	40°	95 %	18 pc(s).	0.261 kg
ACL LINEAR LENS 24x1500mm INTENSE	28002025	1,500 mm	40°	95 %	18 pc(s).	0.326 kg
ACL LINEAR LENS 24x1800mm INTENSE	28002026	1,800 mm	40°	95 %	18 pc(s).	0.392 kg
ACL LINEAR LENS 24x1200mm ASY	28002030	1,200 mm	asymmetric	95 %	18 pc(s).	0.250 kg
ACL LINEAR LENS 24x1500mm ASY	28002031	1,500 mm	asymmetric	95 %	18 pc(s).	0.312 kg
ACL LINEAR LENS 24x1800mm ASY	28002032	1,800 mm	asymmetric	95 %	18 pc(s).	0.375 kg
ACL LINEAR LENS 24x1200mm DASY	28002033	1,200 mm	double asymmetric	92 %	18 pc(s).	0.249 kg
ACL LINEAR LENS 24x1500mm DASY	28002034	1,500 mm	double asymmetric	92 %	18 pc(s).	0.311 kg
ACL LINEAR LENS 24x1800mm DASY	28002035	1,800 mm	double asymmetric	92 %	18 pc(s).	0.373 kg
ACL Endcap LENS 24mm PSF	28002669	-	-	-	3,600 pc(s).	0.003 kg

## 1. Standards

IEC 62031  
IEC 62471  
IEC 61000-4-2  
IEC 62778  
IEC 61547

### 1.1 Photometric code

Key for photometric code, e. g. 830 / 349

1 <sup>st</sup> digit	2 <sup>nd</sup> + 3 <sup>rd</sup> digit	4 <sup>th</sup> digit	5 <sup>th</sup> digit	6 <sup>th</sup> digit
Code CRI	Colour temperature in Kelvin x 100	MacAdam initial	MacAdam after 25% of the lifetime (max.6000h)	Luminous flux after 25% of the lifetime (max.6000h)
7 70 – 79				Code Luminous flux
8 80 – 89				7 ≥ 70 %
9 ≥90				8 ≥ 80 % 9 ≥ 90 %

### 1.2 Energy classification

Type	Colour temperature	Forward current	Energy classification	Energy consumption
LLE 20x280mm 650lm 830 LV SNC4	3,000 K	100 mA	C	4 kWh / 1,000 h
LLE 20x280mm 650lm 840 LV SNC4	4,000 K	100 mA	C	4 kWh / 1,000 h
LLE 20x560mm 1300lm 830 LV SNC4	3,000 K	200 mA	C	7 kWh / 1,000 h
LLE 20x560mm 1300lm 840 LV SNC4	4,000 K	200 mA	C	7 kWh / 1,000 h

Energy label and further information at [www.tridonic.com](http://www.tridonic.com) in the certificates tab of the corresponding product page and at the EPREL data base <https://eprel.ec.europa.eu/>

## 2. Thermal details

### 2.1 tc point, ambient temperature and lifetime

The temperature at tp reference point is crucial for the light output and lifetime of a LED product.

For LLE a tp temperature of 50 °C has to be complied in order to achieve an optimum between heat sink requirements, light output and lifetime.

Compliance with the maximum permissible reference temperature at the tc point must be checked under operating conditions in a thermally stable state. The maximum value must be determined under worst-case conditions for the relevant application.

The tc and tp temperature of LED modules from Tridonic are measured at the same reference point.

### 2.2 Storage and humidity

Storage temperature	-40... +85 °C
---------------------	---------------

Operation only in non condensing environment.

Humidity during processing of the module should be between 30 to 70 %.

## 2.3 Heat sink values

### LLE 20x280mm 650lm 8xx LV SNC4

ta	tp	Forward current	R <sub>th, hs-a</sub>	Cooling area
25 °C	50 °C	100 mA		self cooling
25 °C	50 °C	200 mA	6.53 K/W	102 cm <sup>2</sup>
35 °C	50 °C	100 mA	8.01 K/W	82 cm <sup>2</sup>
35 °C	50 °C	200 mA	3.57 K/W	187 cm <sup>2</sup>
40 °C	50 °C	100 mA	5.05 K/W	130 cm <sup>2</sup>
40 °C	50 °C	200 mA	2.10 K/W	318 cm <sup>2</sup>
45 °C	50 °C	100 mA	2.10 K/W	313 cm <sup>2</sup>

### LLE 20x560mm 1300lm 8xx LV SNC4

ta	tp	Forward current	R <sub>th, hs-a</sub>	Cooling area
25 °C	50 °C	200 mA		self cooling
25 °C	50 °C	400 mA	3.48 K/W	191 cm <sup>2</sup>
35 °C	50 °C	200 mA	4.27 K/W	156 cm <sup>2</sup>
35 °C	50 °C	400 mA	1.92 K/W	347 cm <sup>2</sup>
40 °C	50 °C	200 mA	2.70 K/W	247 cm <sup>2</sup>
40 °C	50 °C	400 mA	1.14 K/W	587 cm <sup>2</sup>
45 °C	50 °C	200 mA	1.14 K/W	587 cm <sup>2</sup>

### Notes

The actual cooling surface can differ because of the material, the structural shape, outside influences and the installation situation. Depending on the heat sink a heat conducting paste or heat conducting film might be necessary to keep the specified tp temperature.

For applications with a small distance between LED module and lens, screw mounting is recommended to ensure a reliable thermal connection between LED module and cooling surface.

### 3. Installation / wiring

#### 3.1 Electrical supply/choice of LED driver

LLE modules from Tridonic are not protected against overvoltages, overcurrents, overloads or short-circuit currents. Safe and reliable operation can only be guaranteed in conjunction with a LED driver which complies with the relevant standards. The use of LED driver from Tridonic in combination with LLE modules guarantees the necessary protection for safe and reliable operation.

If a LED driver other than Tridonic is used, it must provide the following protection:

- Short-circuit protection
- Overload protection
- Overtemperature protection



LLE modules must be supplied by a constant current LED driver. Operation with a constant voltage LED driver will lead to an irreversible damage of the module.

Wrong polarity can damage the LLE.

With parallel wiring tolerance-related differences in output are possible (thermal stress of the module) and can cause differences in brightness.

Wire breakage, poor contact or failure of individual modules can lead to very high temperatures at other modules within the luminaire. This can lead to total failure. Double-sided supply can improve the behaviour in these fault cases.

The max. permissible output current of the LED driver for parallel wiring is 1.8 A.

LLE have to be operated with SELV LED drivers.



LLE are basic insulated up to 60 V SELV (if mounted with M4 screws with head diameter 7 mm in combination with plastic washers) against ground and can be mounted directly on earthed metal parts of the luminaire. If the max. output voltage of the LED driver (also against earth) is above 60 V SELV, an additional insulation between LED module and heat sink is required (for example by insulated thermal pads) or by a suitable luminaire construction.

#### 3.2 Wiring

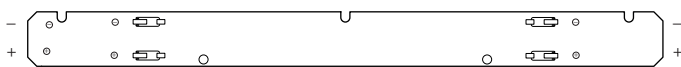

#### Wiring examples

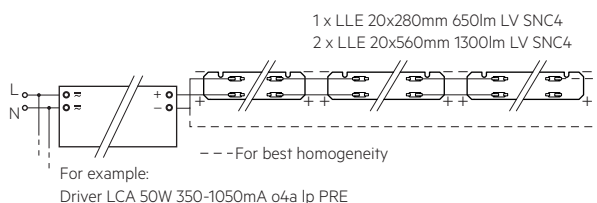
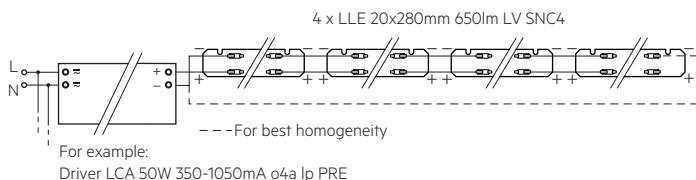

Type	Max. number with parallel wiring*
LLE 20x280mm 650lm LV SNC4	8
LLE 20x560mm 1300lm LV SNC4	4

\* with direkt chaining (without additional terminals).

#### 3.3 Wiring type and cross section

For wiring use stranded wire with ferrules or solid wire from 0.2 to 0.75 mm<sup>2</sup>. For the push-wire connection you have to strip the insulation (8–9 mm).

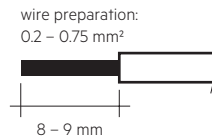

To remove the wires use a suitable tool (e.g. Microcon release pin) or through twist and pull.

#### 3.4 Mounting instruction



None of the components of the LLE (substrate, LED, electronic components etc.) may be exposed to tensile or compressive stresses.

Max. torque for fixing: 0.5 Nm.

The LED modules are mounted onto a heat sink with min. 3 screws per module.



Chemical substance may harm the LED module. Chemical reactions could lead to colour shift, reduced luminous flux or a total failure of the module caused by corrosion of electrical connections.

Materials which are used in LED applications (e.g. sealings, adhesives) must not produce dissolver gas. They must not be condensation curing based, acetate curing based or contain sulfur, chlorine or phthalate.

Avoid corrosive atmosphere during usage and storage.

#### 3.5 EOS/ESD safety guidelines



The device / module contains components that are sensitive to electrostatic discharge and may only be installed in the factory and on site if appropriate EOS/ESD protection measures have been taken. No special measures need be taken for devices/modules with enclosed casings (contact with the pc board not possible), just normal installation practice. Please note the requirements set out in the document EOS / ESD guidelines (Guideline\_EOS\_ESD.pdf) at: <http://www.tridonic.com/esd-protection>

## 4. Lifetime

### 4.1 Lifetime, lumen maintenance and failure rate

The light output of an LED module decreases over the lifetime, this is characterized with the L value.

L70 means that the LED module will give 70 % of its initial luminous flux.

This value is always related to the number of operation hours and therefore defines the lifetime of an LED module.

As the L value is a statistical value and the lumen maintenance may vary over the delivered LED modules.

The B value defines the amount of modules which are below the specific L value, e.g. L70B10 means 10 % of the LED modules are below 70 % of the initial luminous flux, respectively 90 % will be above 70 % of the initial value.

In addition the percentage of failed modules (fatal failure) is characterized by the C value.

### 4.2 Lumen maintenance for LLE 20mm LV SNC4

Forward current	tp						
	tempera- ture	L90 / B10	L90 / B50	L80 / B10	L80 / B50	L70 / B10	L70 / B50
50 mA / ft (280 mm Modullänge)	50 °C	>72k h	>72k h	>72k h	>72k h	>72k h	>72k h
	60 °C	>72k h	>72k h	>72k h	>72k h	>72k h	>72k h
	85 °C	>72k h	>72k h	>72k h	>72k h	>72k h	>72k h
100 mA / ft (280 mm Modullänge)	50 °C	>72k h	>72k h	>72k h	>72k h	>72k h	>72k h
	60 °C	>72k h	>72k h	>72k h	>72k h	>72k h	>72k h
	85 °C	>72k h	>72k h	>72k h	>72k h	>72k h	>72k h
175 mA / ft (280 mm Modullänge)	50 °C	42k h	44k h	>72k h	>72k h	>72k h	>72k h
	60 °C	42k h	44k h	>72k h	>72k h	>72k h	>72k h
	85 °C	42k h	44k h	>72k h	>72k h	>72k h	>72k h

L00C03 >72k h. At tp rated, based on 10 swichting cycles per day.

### 4.3 Switching capability

100,000 cycles

Test according to IEC 62717 CI 10.3.3

30 s on / 30 s off at I<sub>max</sub>

## 5. Electrical values

### 5.1 Declaration of electrical parameters

Irated ... Nominal operating current the module is designed for.

I<sub>max</sub> ... Max. permissible continuous operating current incl. The tolerances of the LED driver.

Max. permissible LF current ripple ... Max. output current of the LED driver incl. Tolerances and LF current ripple must not exceed this value.

Max. permissible peak current ... The max. output peak current of the LED driver must not exceed this value.

### 5.2 Typ. forward voltage vs. forward current

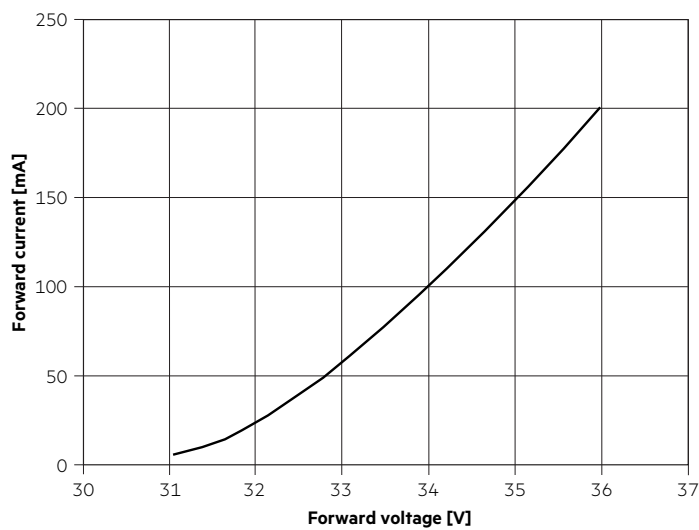

### 5.3 Forward voltage vs. tc temperature

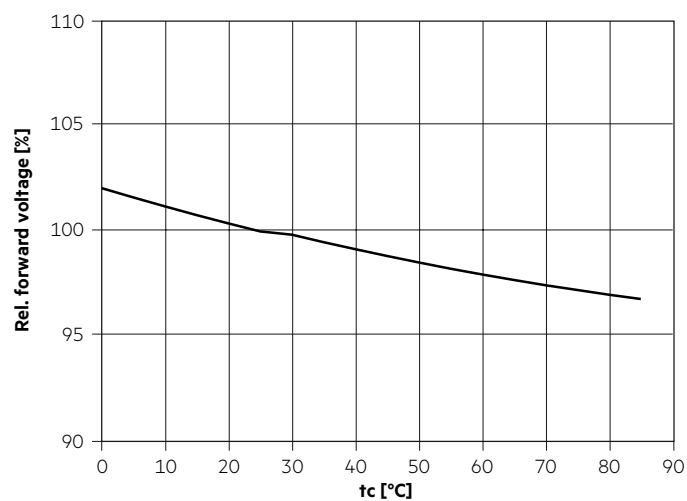

The diagrams are based on statistic values.  
The real values can be different.

## 6. Photometric characteristics

### 6.1 Coordinates and tolerances according to CIE 1931

The specified colour coordinates are integral measured by current impulse of 150 mA and a duration of 100 ms.  
 The ambient temperature of the measurement is  $t_a = 25^\circ\text{C}$ .  
 The measurement tolerance of the colour coordinates are  $\pm 0.01$ .

#### 3,000 K

	x0	y0
Centre	0.4338	0.4030

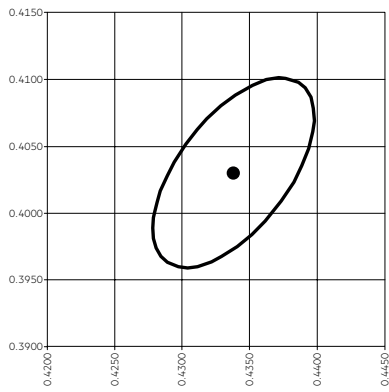

— MacAdam Ellipse: 3SDCM

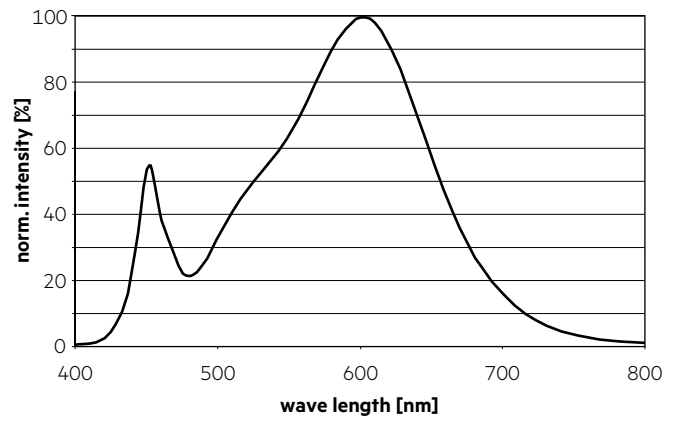

#### 4,000 K

	x0	y0
Center	0.3818	0.3797

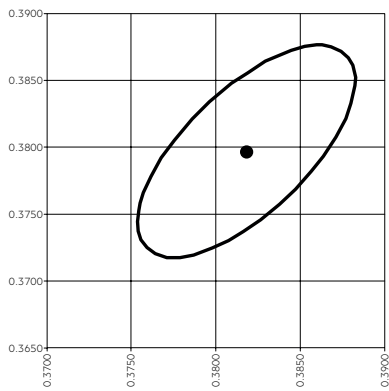

— MacAdam Ellipse: 3SDCM

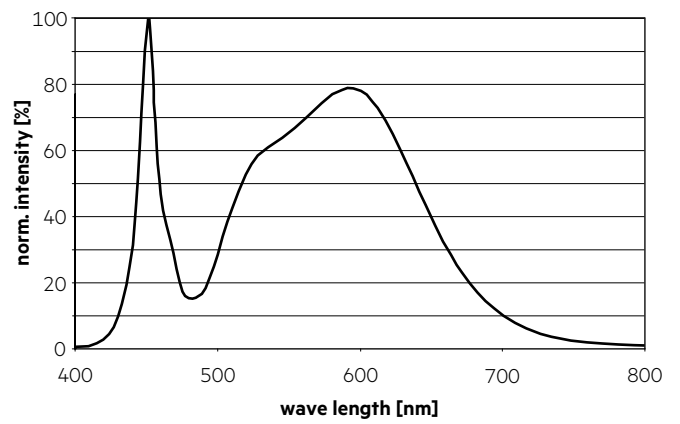

## 6.2 Light distribution

The optical design of the LLE product line ensures optimum homogeneity for the light distribution.

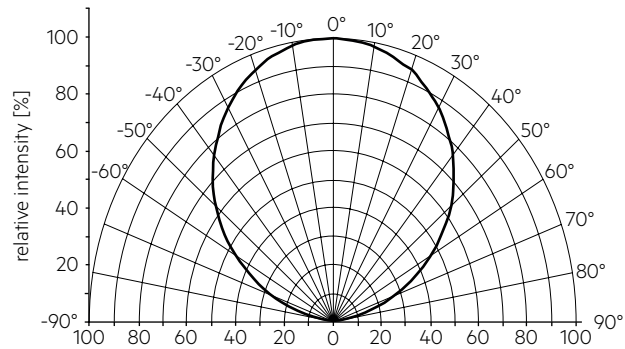

The colour temperature is measured integral over the complete module. The single LED light points can have deviations in the colour coordinates within MacAdam 5.

To ensure an ideal mixture of colours and a homogeneous light distribution a suitable optic (e. g. PMMA diffuser) and a sufficient spacing between module and optic (typ. 4 cm) should be used.

## 6.3 Relative luminous flux vs. tc temperature

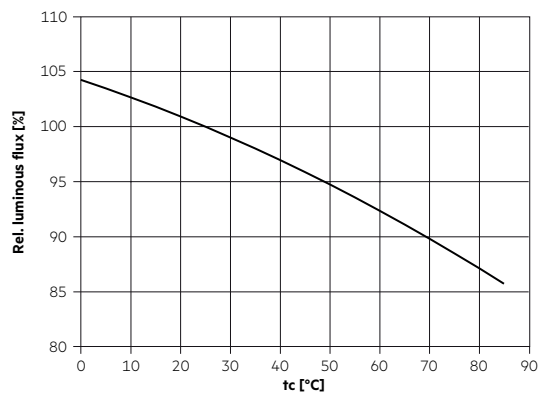

## 6.4 Relative luminous flux vs. operating current

### LLE 20x280mm 650lm 8xx LV SNC4

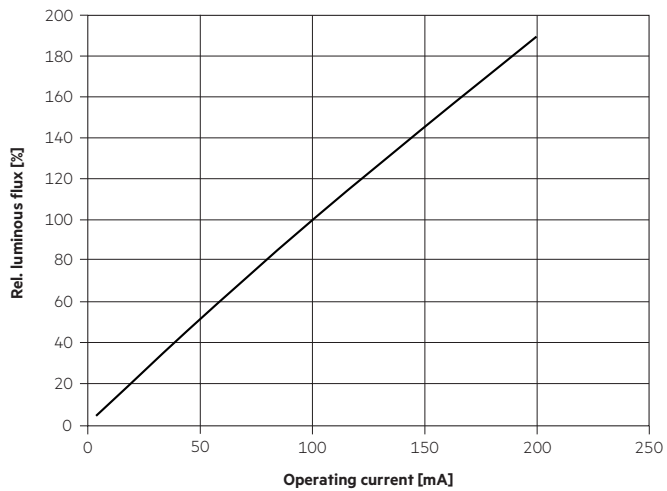

### LLE 20x560mm 1300lm 8xx LV SNC4

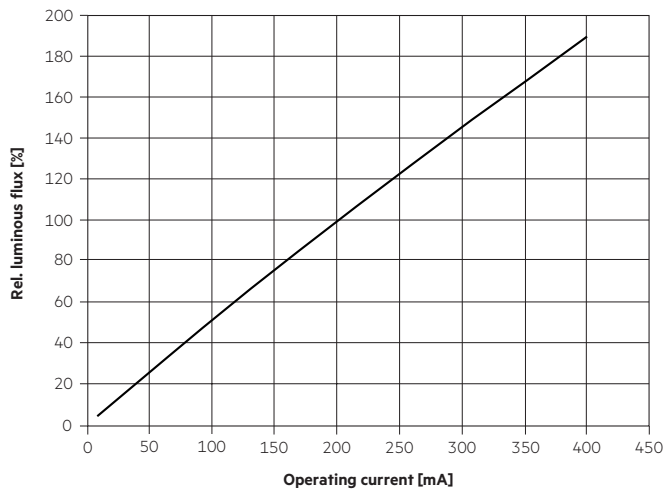

The diagrams are based on statistic values.  
The real values can be different.

## 7. Miscellaneous

### 7.1 Additional information

Additional technical information at [www.tridonic.com](http://www.tridonic.com) → Technical Data

Guarantee conditions at [www.tridonic.com](http://www.tridonic.com) → Services

Lifetime declarations are informative and represent no warranty claim.