

**Module LLE 20x280-560mm 1250lm LV SNC3**

Modules LLE essence



LLE 20x280mm 1250lm LV SNC3



LLE 20x560mm 2400lm LV SNC3

**Product description**

- \_ Optimal solution for linear and panel lights where cost is main priority, together with the new LC Ip SNC and ADV LED driver provides best system efficiency
- \_ 4 terminals for parallel wiring
- \_ Perfectly uniform light, even if several LED modules are used together in a line
- \_ Push terminals for quick and simple wiring of LED module to LED module
- \_ HE ... High Efficiency, NM ... Nominal Mode, HO ... High Output
- \_ Long lifetime up to 72,000 hours
- \_ 5 years guarantee (conditions at <https://www.tridonic.com/manufacture-guarantee-conditions>)

**Optical properties**

- \_ Colour temperatures 3,000, 4,000 and 6,500 K
- \_ Useful luminous flux 2,330 lm at Irated and tp = 25 °C
- \_ Efficacy of the LED module 171 lm/W at Irated and tp = 25 °C
- \_ High colour rendering index CRI > 80
- \_ Small colour tolerance (MacAdam 3) ①
- \_ Small luminous flux tolerances

**Mechanical properties**

- \_ Module dimension 20 x 280 mm and 20 x 560 mm
- \_ Simple installation (e.g. screws)

① Integral measurement over the complete module.

**Website**

<http://www.tridonic.com/28002932>

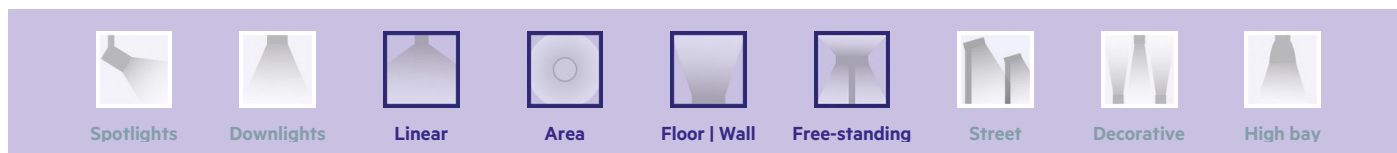
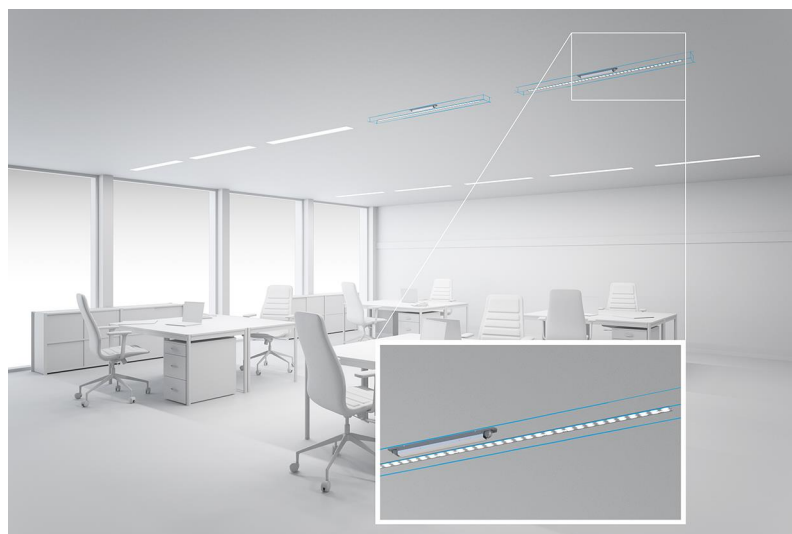



**Technical data**

Beam characteristic	120°
Ambient temperature ta	-40 ... +65 °C
tp rated	50 °C
tc	90 °C
Irated for 1,250 lm	200 mA
Irated for 2,400 lm	400 mA
Imax for 1,250 lm	360 mA
Imax for 2,400 lm	720 mA
Max. permissible LF current ripple for 1,250 lm	400 mA
Max. permissible LF current ripple for 2,400 lm	800 mA
Max. permissible peak current for 1,250 lm	600 mA / max. 10 ms
Max. permissible peak current for 2,400 lm	1,200 mA / max. 10 ms
Max. working voltage for insulation SELV <sup>②</sup>	< 60 V
Insulation test voltage	0.5 kV
CTI of the printed circuit board	≥ 600
Colour tolerance	3 SDCM
ESD classification	Severity level 2
Risk group (IEC 62471) <sup>③</sup>	RG1
Classification acc. to IEC 62031	Built-in
Type of protection	IPO0
Lumen maintenance L70B50	72,000 h
Guarantee (conditions at www.tridonic.com)	5 Year(s)

**Approval marks****Standards**

IEC 62031, IEC 62471, IEC 61000-4-2, IEC 62778, IEC 61547

**Specific technical data**

Type	Article number	Photometric code	Useful luminous flux at tp = 25 °C <sup>④</sup>	Expected luminous flux at tp rated <sup>⑤</sup>	Typ. forward current	Min. forward voltage at tp rated	Max. forward voltage at tp = 25 °C	Power consumption Pon at tp = 25 °C <sup>⑥</sup>	Efficacy of the module at tp = 25 °C	Expected efficacy of the module at tp rated	Colour rendering index CRI
<b>Operating mode NM at 200 mA per feet (280 mm module length)</b>											
LLE 20x280mm 1250lm 830 LV SNC3	28002932	830/359	1,110 lm	1,050 lm	200 mA	31.3 V	36.9 V	6.8 W	163 lm/W	156 lm/W	>>80
LLE 20x280mm 1250lm 840 LV SNC3	28002933	840/359	1,160 lm	1,100 lm	200 mA	31.3 V	36.9 V	6.8 W	171 lm/W	165 lm/W	>>80
LLE 20x280mm 1250lm 865 LV SNC3	28002934	865/359	1,160 lm	1,100 lm	200 mA	31.3 V	36.9 V	6.8 W	171 lm/W	165 lm/W	>>80
LLE 20x560mm 2400lm 830 LV SNC3	28002935	830/359	2,220 lm	2,100 lm	400 mA	31.3 V	36.9 V	13.6 W	163 lm/W	156 lm/W	>>80
LLE 20x560mm 2400lm 840 LV SNC3	28002936	840/359	2,330 lm	2,210 lm	400 mA	31.3 V	36.9 V	13.6 W	171 lm/W	164 lm/W	>>80
LLE 20x560mm 2400lm 865 LV SNC3	28002937	865/359	2,330 lm	2,210 lm	400 mA	31.3 V	36.9 V	13.6 W	171 lm/W	164 lm/W	>>80
<b>Operating mode HO at 250 mA per feet (280 mm module length)</b>											
LLE 20x280mm 1250lm 830 LV SNC3	28002932	830/359	-	1,290 lm	250 mA	31.9 V	37.6 V	-	-	151 lm/W	>>80
LLE 20x280mm 1250lm 840 LV SNC3	28002933	840/359	-	1,360 lm	250 mA	31.9 V	37.6 V	-	-	159 lm/W	>>80
LLE 20x280mm 1250lm 865 LV SNC3	28002934	865/359	-	1,360 lm	250 mA	31.9 V	37.6 V	-	-	159 lm/W	>>80
LLE 20x560mm 2400lm 830 LV SNC3	28002935	830/359	-	2,580 lm	500 mA	31.9 V	37.6 V	-	-	151 lm/W	>>80
LLE 20x560mm 2400lm 840 LV SNC3	28002936	840/359	-	2,710 lm	500 mA	31.9 V	37.6 V	-	-	158 lm/W	>>80
LLE 20x560mm 2400lm 865 LV SNC3	28002937	865/359	-	2,710 lm	500 mA	31.9 V	37.6 V	-	-	158 lm/W	>>80
<b>Operating mode HO at 300 mA per feet (280 mm module length)</b>											
LLE 20x280mm 1250lm 830 LV SNC3	28002932	830/359	-	1,520 lm	300 mA	32.6 V	38.4 V	-	-	145 lm/W	>>80
LLE 20x280mm 1250lm 840 LV SNC3	28002933	840/359	-	1,600 lm	300 mA	32.6 V	38.4 V	-	-	153 lm/W	>>80
LLE 20x280mm 1250lm 865 LV SNC3	28002934	865/359	-	1,600 lm	300 mA	32.6 V	38.4 V	-	-	153 lm/W	>>80
LLE 20x560mm 2400lm 830 LV SNC3	28002935	830/359	-	3,050 lm	600 mA	32.6 V	38.4 V	-	-	146 lm/W	>>80
LLE 20x560mm 2400lm 840 LV SNC3	28002936	840/359	-	3,210 lm	600 mA	32.6 V	38.4 V	-	-	153 lm/W	>>80
LLE 20x560mm 2400lm 865 LV SNC3	28002937	865/359	-	3,210 lm	600 mA	32.6 V	38.4 V	-	-	153 lm/W	>>80
<b>Operating mode HO at 350 mA per feet (280 mm module length)</b>											
LLE 20x280mm 1250lm 830 LV SNC3	28002932	830/359	-	1,750 lm	350 mA	33.3 V	39.2 V	-	-	140 lm/W	>>80
LLE 20x280mm 1250lm 840 LV SNC3	28002933	840/359	-	1,840 lm	350 mA	33.3 V	39.2 V	-	-	147 lm/W	>>80
LLE 20x280mm 1250lm 865 LV SNC3	28002934	865/359	-	1,840 lm	350 mA	33.3 V	39.2 V	-	-	147 lm/W	>>80
LLE 20x560mm 2400lm 830 LV SNC3	28002935	830/359	-	3,510 lm	700 mA	33.3 V	39.2 V	-	-	141 lm/W	>>80
LLE 20x560mm 2400lm 840 LV SNC3	28002936	840/359	-	3,690 lm	700 mA	33.3 V	39.2 V	-	-	148 lm/W	>>80
LLE 20x560mm 2400lm 865 LV SNC3	28002937	865/359	-	3,690 lm	700 mA	33.3 V	39.2 V	-	-	148 lm/W	>>80

② If mounted with M4 screws and plastic washers.

③ Measured at operating mode HO.

④ Tolerance of useful light flux - 0 % / + 15 %. Measurement uncertainty ± 10 %.

⑤ Tolerance of expected light flux - 0 % / + 15 %. Measurement uncertainty ± 10 %. Based on calculation.

⑥ Tolerance of power consumption Pon ± 10 %. Measurement uncertainty ± 5 %.



## ACL ENDCAP LLE

Accessory

**Product description**

- \_ ENDCAP for LLE
- \_ PUSH-FIX: Fast snap on mounting (sheet thickness 0.5 – 1.0 mm), for drilling hole 4 mm
- \_ SCREW-FIX: Screw mounting with EJOT Delta PT WN 5451 30x8 (not included), tightening torque 0.7 Nm
- \_ Clip made of polycarbonate

**Website**

<http://www.tridonic.com/28004379>

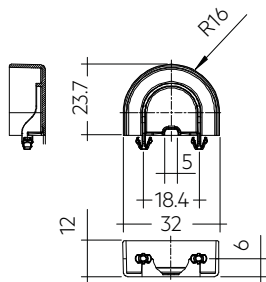
**Ordering data**

Type	Article number	Colour	Packaging, carton	Weight per pc.
ACL ENDCAP LLE20 PUSH-FIX	28004379	White	1,500 pc(s).	0.003 kg
ACL ENDCAP LLE24 PUSH-FIX	28001037	White	480 pc(s).	0.003 kg
ACL ENDCAP LLE24 SCREW-FIX	28002315	White	480 pc(s).	0.003 kg

## ACL LINEAR LENS 24mm

Accessory

**Product description LINEAR LENS**

- \_ Linear lens for LLE 20 / 24
- \_ Available with different beam characteristics
- \_ Protection against direct touch for non-SELV applications (recommendation: use all fixing points)
- \_ Fast snap on mounting on to LLE 20: with M4 screws and plastic washers, to LLE 24: with clips or plastic washers
- \_ Recommendation: Fastening with screws and plastic washers, see 2.3 Heat sink specifications in data sheet
- \_ Material: PMMA
- \_ Available lengths: 1,200, 1,500 and 1,800 mm, Tolerance: + 10 mm (ends raw)
- \_ Max. permissible temperature 80 °C
- \_ Photometric data available on website

**Product description Endcap**

- \_ ENDCAP for LINEAR LENS 24mm INTENSE, ASY and DASY
- \_ Mounting by clipping in and screwing from below using screw EJOT Delta PT WN 5451 20x4, tightening torque 0.7 Nm
- \_ Made of Polyamide UL94 V0

**Website**

<http://www.tridonic.com/28001428>

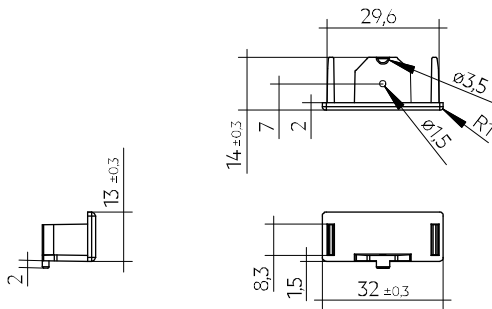
**Ordering data**

Type	Article number	Length L	Beam characteristic	Efficiency	Packaging, carton	Weight per pc.
ACL LINEAR LENS 24x1200mm 60°	28001428	1,200 mm	60°	97 %	21 pc(s).	0.196 kg
ACL LINEAR LENS 24x1200mm 90°	28001429	1,200 mm	90°	97 %	21 pc(s).	0.165 kg
ACL LINEAR LENS 24x1500mm 60°	28000953	1,500 mm	60°	97 %	21 pc(s).	0.261 kg
ACL LINEAR LENS 24x1500mm 90°	28000955	1,500 mm	90°	97 %	21 pc(s).	0.221 kg
ACL LINEAR LENS 24x1200mm INTENSE	28002024	1,200 mm	40°	95 %	18 pc(s).	0.261 kg
ACL LINEAR LENS 24x1500mm INTENSE	28002025	1,500 mm	40°	95 %	18 pc(s).	0.326 kg
ACL LINEAR LENS 24x1800mm INTENSE	28002026	1,800 mm	40°	95 %	18 pc(s).	0.392 kg
ACL LINEAR LENS 24x1200mm ASY	28002030	1,200 mm	asymmetric	95 %	18 pc(s).	0.250 kg
ACL LINEAR LENS 24x1500mm ASY	28002031	1,500 mm	asymmetric	95 %	18 pc(s).	0.312 kg
ACL LINEAR LENS 24x1800mm ASY	28002032	1,800 mm	asymmetric	95 %	18 pc(s).	0.375 kg
ACL LINEAR LENS 24x1200mm DASY	28002033	1,200 mm	double asymmetric	92 %	18 pc(s).	0.249 kg
ACL LINEAR LENS 24x1500mm DASY	28002034	1,500 mm	double asymmetric	92 %	18 pc(s).	0.311 kg
ACL LINEAR LENS 24x1800mm DASY	28002035	1,800 mm	double asymmetric	92 %	18 pc(s).	0.373 kg
ACL Endcap LENS 24mm PSF	28002669	-	-	-	3,600 pc(s).	0.003 kg

## 1. Standards

IEC 62031  
IEC 62471  
IEC 61000-4-2  
IEC 62778  
IEC 61547

### 1.1 Photometric code

Key for photometric code, e. g. 830 / 349

1 <sup>st</sup> digit	2 <sup>nd</sup> + 3 <sup>rd</sup> digit	4 <sup>th</sup> digit	5 <sup>th</sup> digit	6 <sup>th</sup> digit
Code CRI	Colour temperature in Kelvin x 100	MacAdam initial	MacAdam after 25% of the lifetime (max.6000h)	Luminous flux after 25% of the lifetime (max.6000h)
7 70 – 79				Code Luminous flux
8 80 – 89				7 ≥ 70 %
9 ≥90				8 ≥ 80 % 9 ≥ 90 %

### 1.2 Energy classification

Type	Colour temperature	Forward current	Energy classification	Energy consumption
LLE 20x280mm 1250lm 830 LV SNC3	3,000 K	200 mA	D	7 kWh / 1,000 h
LLE 20x280mm 1250lm 840 LV SNC3	4,000 K	200 mA	D	7 kWh / 1,000 h
LLE 20x280mm 1250lm 865 LV SNC3	6,500 K	200 mA	D	7 kWh / 1,000 h
LLE 20x560mm 2400lm 830 LV SNC3	3,000 K	400 mA	D	14 kWh / 1,000 h
LLE 20x560mm 2400lm 840 LV SNC3	4,000 K	400 mA	D	14 kWh / 1,000 h
LLE 20x560mm 2400lm 865 LV SNC3	6,500 K	400 mA	D	14 kWh / 1,000 h

Energy label and further information at [www.tridonic.com](http://www.tridonic.com) in the certificates tab of the corresponding product page and at the EPREL data base <https://eprel.ec.europa.eu/>

## 2. Thermal details

### 2.1 tc point, ambient temperature and lifetime

The temperature at tp reference point is crucial for the light output and lifetime of a LED product.

For LLE a tp temperature of 50 °C has to be complied in order to achieve an optimum between heat sink requirements, light output and lifetime.

Compliance with the maximum permissible reference temperature at the tc point must be checked under operating conditions in a thermally stable state. The maximum value must be determined under worst-case conditions for the relevant application.

The tc and tp temperature of LED modules from Tridonic are measured at the same reference point.

### 2.2 Storage and humidity

Storage temperature	-40 ... +85 °C
---------------------	----------------

Operation only in non condensing environment.  
Humidity during processing of the module should be between 30 to 70 %.

## 2.3 Heat sink values

### LLE 24x280mm 1250lm 8xx LV SNC3

ta	tp	Forward current	R <sub>th, hs-a</sub>	Cooling area
25 °C	50 °C	150 mA	9.84 K/W	68 cm <sup>2</sup>
25 °C	50 °C	200 mA	6.97 K/W	96 cm <sup>2</sup>
25 °C	50 °C	300 mA	4.22 K/W	158 cm <sup>2</sup>
35 °C	50 °C	150 mA	5.90 K/W	113 cm <sup>2</sup>
35 °C	50 °C	200 mA	4.18 K/W	160 cm <sup>2</sup>
35 °C	50 °C	300 mA	2.53 K/W	263 cm <sup>2</sup>
40 °C	50 °C	150 mA	3.93 K/W	170 cm <sup>2</sup>
40 °C	50 °C	200 mA	2.78 K/W	240 cm <sup>2</sup>
40 °C	50 °C	300 mA	1.68 K/W	396 cm <sup>2</sup>
45 °C	50 °C	150 mA	1.96 K/W	340 cm <sup>2</sup>
45 °C	50 °C	200 mA	1.39 K/W	481 cm <sup>2</sup>
45 °C	50 °C	300 mA	0.84 K/W	795 cm <sup>2</sup>

### LLE 24x560mm 2400lm 8xx LV SNC3

ta	tp	Forward current	R <sub>th, hs-a</sub>	Cooling area
25 °C	50 °C	300 mA	4.90 K/W	136 cm <sup>2</sup>
25 °C	50 °C	400 mA	3.47 K/W	192 cm <sup>2</sup>
25 °C	50 °C	600 mA	2.10 K/W	318 cm <sup>2</sup>
35 °C	50 °C	300 mA	2.94 K/W	227 cm <sup>2</sup>
35 °C	50 °C	400 mA	2.08 K/W	320 cm <sup>2</sup>
35 °C	50 °C	600 mA	1.26 K/W	531 cm <sup>2</sup>
40 °C	50 °C	300 mA	1.96 K/W	340 cm <sup>2</sup>
40 °C	50 °C	400 mA	1.39 K/W	481 cm <sup>2</sup>
40 °C	50 °C	600 mA	0.84 K/W	797 cm <sup>2</sup>
45 °C	50 °C	300 mA	0.98 K/W	682 cm <sup>2</sup>
45 °C	50 °C	400 mA	0.69 K/W	964 cm <sup>2</sup>
45 °C	50 °C	600 mA	0.42 K/W	1.602 cm <sup>2</sup>

### Notes

The actual cooling surface can differ because of the material, the structural shape, outside influences and the installation situation. Depending on the heat sink a heat conducting paste or heat conducting film might be necessary to keep the specified tp temperature.

### 3. Installation / wiring

#### 3.1 Electrical supply/choice of LED driver

LLE modules from Tridonic are not protected against overvoltages, overcurrents, overloads or short-circuit currents. Safe and reliable operation can only be guaranteed in conjunction with a LED driver which complies with the relevant standards. The use of LED driver from Tridonic in combination with LLE modules guarantees the necessary protection for safe and reliable operation.

If a LED driver other than Tridonic is used, it must provide the following protection:

- Short-circuit protection
- Overload protection
- Overtemperature protection



LLE modules must be supplied by a constant current LED driver. Operation with a constant voltage LED driver will lead to an irreversible damage of the module.

Wrong polarity can damage the LLE.

With parallel wiring tolerance-related differences in output are possible (thermal stress of the module) and can cause differences in brightness.

If a wire breaks or a complete module fails then the current passing through the other module increases. This may reduce its life considerably.

The max. permissible output current of the LED driver for parallel wiring is 3 A.

LLE have to be operated with SELV LED drivers.



LLE are basic insulated up to 60 V SELV (if mounted with M4 screws with head diameter 7 mm in combination with plastic washers) against ground and can be mounted directly on earthed metal parts of the luminaire. If the max. output voltage of the LED driver (also against earth) is above 60 V SELV, an additional insulation between LED module and heat sink is required (for example by insulated thermal pads) or by a suitable luminaire construction.

#### 3.2 Wiring

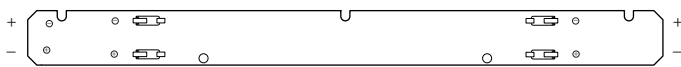

#### Wiring examples

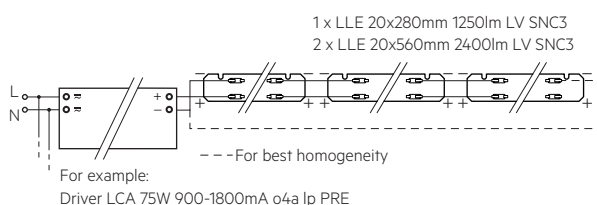
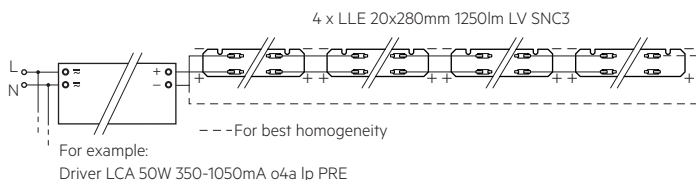

Type	Max. number with parallel wiring*
LLE 20x280mm 1250lm LV SNC3	6
LLE 20x560mm 2400lm LV SNC3	3

\* with direkt chaining (without additional terminals).

#### 3.3 Wiring type and cross section

For wiring use stranded wire with ferrules or solid wire from 0.2 to 0.75 mm<sup>2</sup>. For the push-wire connection you have to strip the insulation (8–9 mm).

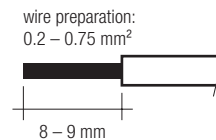

To remove the wires use a suitabel tool (e.g. Microcon release pin) or through twist and pull.

#### 3.4 Mounting instruction



None of the components of the LLE (substrate, LED, electronic components etc.) may be exposed to tensile or compressive stresses.

Max. torque for fixing: 0.5 Nm.

The LED modules are mounted onto a heat sink with min. 3 screws per module.



Chemical substance may harm the LED module. Chemical reactions could lead to colour shift, reduced luminous flux or a total failure of the module caused by corrosion of electrical connections.

Materials which are used in LED applications (e.g. sealings, adhesives) must not produce dissolver gas. They must not be condensation curing based, acetate curing based or contain sulfur, chlorine or phthalate.

Avoid corrosive atmosphere during usage and storage.

#### 3.5 EOS/ESD safety guidelines



The device / module contains components that are sensitive to electrostatic discharge and may only be installed in the factory and on site if appropriate EOS/ESD protection measures have been taken. No special measures need be taken for devices/modules with enclosed casings (contact with the pc board not possible), just normal installation practice. Please note the requirements set out in the document EOS / ESD guidelines (Guideline\_EOS\_ESD.pdf) at: <http://www.tridonic.com/esd-protection>



## 4. Lifetime

### 4.1 Lifetime, lumen maintenance and failure rate

The light output of an LED module decreases over the lifetime, this is characterized with the L value.

L70 means that the LED module will give 70 % of its initial luminous flux.

This value is always related to the number of operation hours and therefore defines the lifetime of an LED module.

As the L value is a statistical value and the lumen maintenance may vary over the delivered LED modules.

The B value defines the amount of modules which are below the specific L value, e.g. L70B10 means 10 % of the LED modules are below 70 % of the initial luminous flux, respectively 90 % will be above 70 % of the initial value.

In addition the percentage of failed modules (fatal failure) is characterized by the C value.

The F value is the combination of the B and C value. That means for F degradation and complete failures are considered, e.g. L70F10 means 10 % of the LED modules may fail or be below 70 % of the initial luminous flux.

### 4.2 Lumen maintenance for LLE 20mm LV SNC3

Forward current	tp						
	tempera- ture	L90 / F10	L90 / F50	L80 / F10	L80 / F50	L70 / F10	L70 / F50
100 mA / ft (280 mm module length)	40 °C	42,000 h	58,000 h	>72,000 h	>72,000 h	>72,000 h	>72,000 h
	45 °C	41,000 h	56,000 h	>72,000 h	>72,000 h	>72,000 h	>72,000 h
	50 °C	40,000 h	54,000 h	>72,000 h	>72,000 h	>72,000 h	>72,000 h
	55 °C	40,000 h	52,000 h	>72,000 h	>72,000 h	>72,000 h	>72,000 h
	60 °C	39,000 h	51,000 h	>72,000 h	>72,000 h	>72,000 h	>72,000 h
	65 °C	38,000 h	49,000 h	>72,000 h	>72,000 h	>72,000 h	>72,000 h
	70 °C	37,000 h	48,000 h	>72,000 h	>72,000 h	>72,000 h	>72,000 h
	75 °C	36,000 h	46,000 h	>72,000 h	>72,000 h	>72,000 h	>72,000 h
	80 °C	35,000 h	45,000 h	>72,000 h	>72,000 h	>72,000 h	>72,000 h
	85 °C	34,000 h	44,000 h	70,000 h	>72,000 h	>72,000 h	>72,000 h
200 mA / ft (280 mm module length)	40 °C	43,000 h	58,000 h	>72,000 h	>72,000 h	>72,000 h	>72,000 h
	45 °C	42,000 h	57,000 h	>72,000 h	>72,000 h	>72,000 h	>72,000 h
	50 °C	41,000 h	55,000 h	>72,000 h	>72,000 h	>72,000 h	>72,000 h
	55 °C	40,000 h	53,000 h	>72,000 h	>72,000 h	>72,000 h	>72,000 h
	60 °C	39,000 h	51,000 h	>72,000 h	>72,000 h	>72,000 h	>72,000 h
	65 °C	38,000 h	50,000 h	>72,000 h	>72,000 h	>72,000 h	>72,000 h
	70 °C	37,000 h	48,000 h	>72,000 h	>72,000 h	>72,000 h	>72,000 h
	75 °C	36,000 h	47,000 h	>72,000 h	>72,000 h	>72,000 h	>72,000 h
	80 °C	36,000 h	45,000 h	>72,000 h	>72,000 h	>72,000 h	>72,000 h
	85 °C	35,000 h	44,000 h	>72,000 h	>72,000 h	>72,000 h	>72,000 h

### 4.3 Switching capability

100,000 cycles

Tridonic test according to IEC 62717 Cl 10.3.3

30 s on / 30 s off at I<sub>max</sub>

## 5. Electrical values

### 5.1 Declaration of electrical parameters

Irated ... Nominal operating current the module is designed for.

I<sub>max</sub> ... Max. permissible continuous operating current incl. The tolerances of the LED driver.

Max. permissible LF current ripple ... Max. output current of the LED driver incl. Tolerances and LF current ripple must not exceed this value.

Max. permissible peak current ... The max. output peak current of the LED driver must not exceed this value.

### 5.2 Typ. forward voltage vs. forward current

LLE 20x280mm 1250lm 8xx LV SNC3

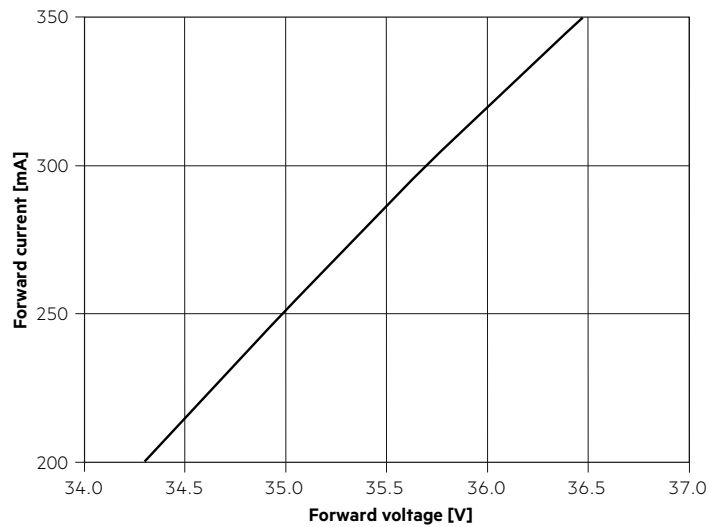

LLE 20x560mm 2400lm 8xx LV SNC3

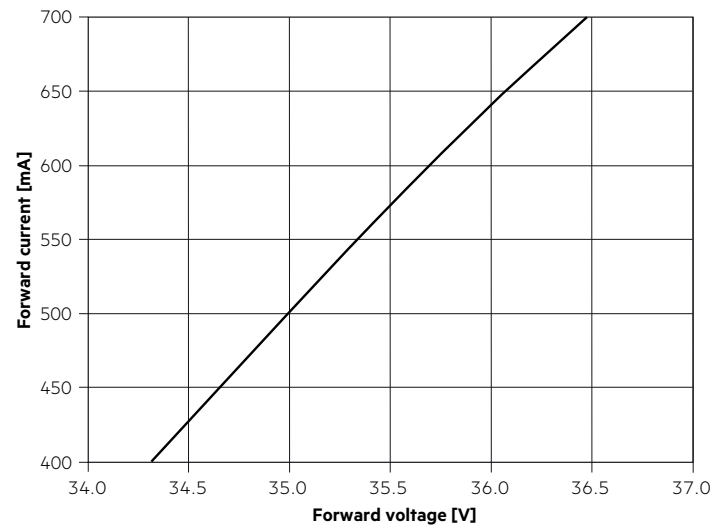

### 5.3 Forward voltage vs. tc temperature

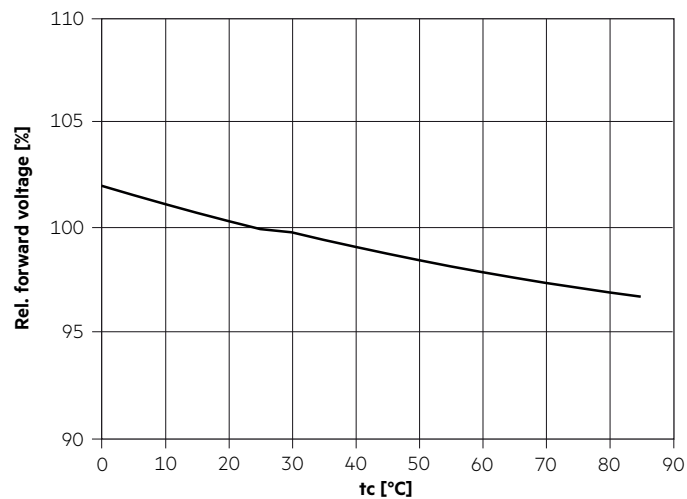

The diagrams are based on statistic values.  
The real values can be different.

## 6. Photometric characteristics

### 6.1 Coordinates and tolerances according to CIE 1931

The specified colour coordinates are integral measured by current impulse of 195 mA and a duration of 100 ms.  
 The ambient temperature of the measurement is  $t_a = 25^\circ\text{C}$ .  
 The measurement tolerance of the colour coordinates are  $\pm 0.01$ .

#### 3,000 K

	x0	y0
Centre	0.4354	0.4009

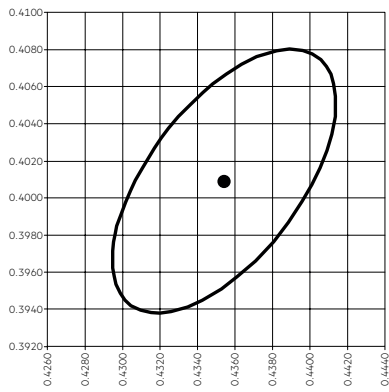

— MacAdam Ellipse: 3SDCM

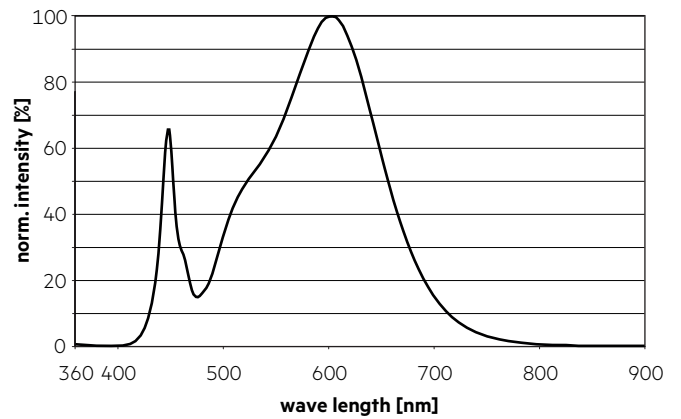

#### 4,000 K

	x0	y0
Center	0.3830	0.3771

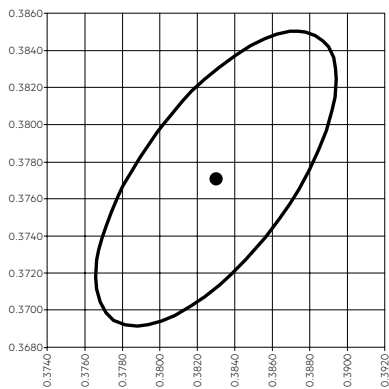

— MacAdam Ellipse: 3SDCM

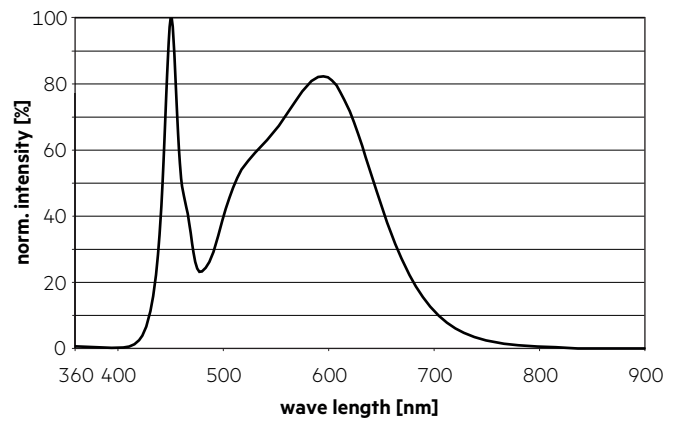

#### 6,500 K

	x0	y0
Center	0.3129	0.3261

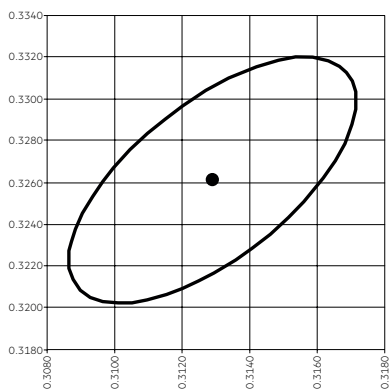

— MacAdam Ellipse: 3SDCM

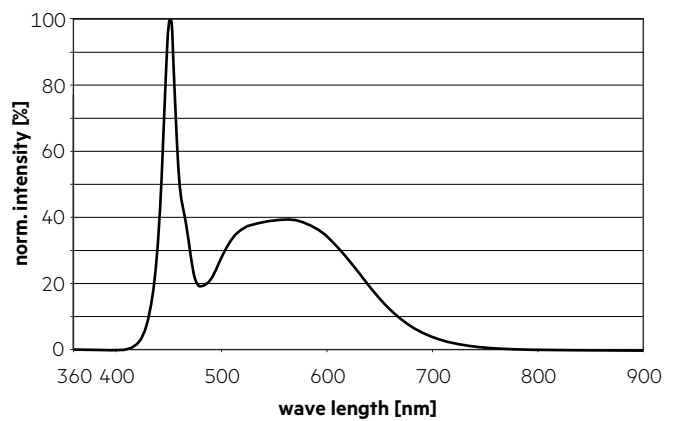

## 6.2 Light distribution

The optical design of the LLE product line ensures optimum homogeneity for the light distribution.

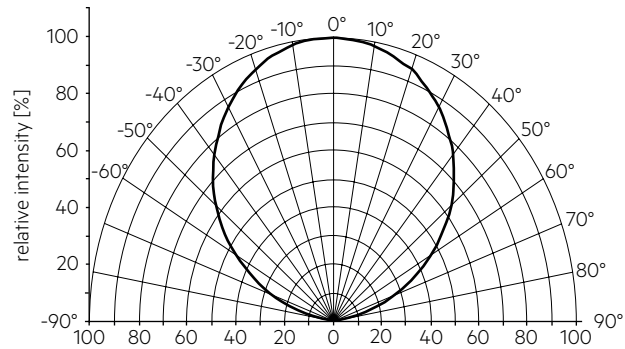

The colour temperature is measured integral over the complete module. The single LED light points can have deviations in the colour coordinates within MacAdam 5. To ensure an ideal mixture of colours and a homogeneous light distribution a suitable optic (e. g. PMMA diffuser) and a sufficient spacing between module and optic (typ. 4 cm) should be used.

## 6.3 Relative luminous flux vs. tc temperature

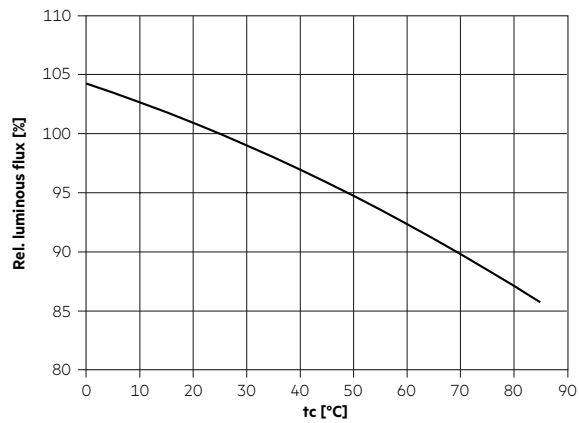

## 6.4 Relative luminous flux vs. operating current

### LLE 20x280mm 1250lm 8xx LV SNC3

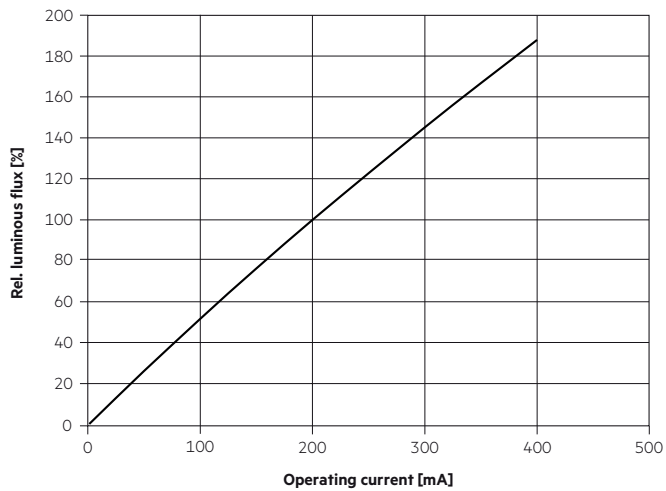

### LLE 20x560mm 2400lm 8xx LV SNC3

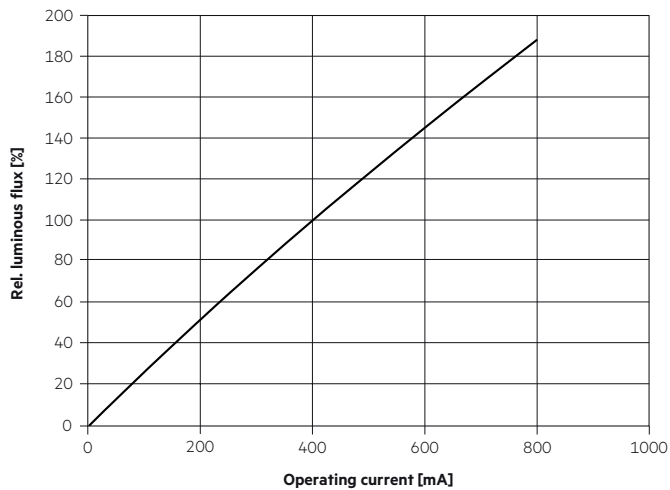

The diagrams are based on statistic values.  
The real values can be different.

## 7. Miscellaneous

### 7.1 Additional information

Additional technical information at [www.tridonic.com](http://www.tridonic.com) → Technical Data

Guarantee conditions at [www.tridonic.com](http://www.tridonic.com) → Services

Lifetime declarations are informative and represent no warranty claim.