

Module LLE 20x1120 / 20x1400mm HV SNC3

Modules LLE essence



LLE 20x1120mm 4400lm HV SNC3



LLE 20x1400mm 5500lm HV SNC3

Product description

- _ Ideal for linear and panel lights
- _ Push terminals for quick and simple wiring
- _ 3rd push terminal and integrated return path for easy wiring from one side of the module
- _ Reduced mounting and wiring effort
- _ HE ... High Efficiency, NM ... Nominal Mode, HO ... High Output
- _ Long lifetime up to 72,000 hours
- _ 5 years guarantee (Conditions at <https://www.tridonic.com/manufacture-guarantee-conditions>)

Optical properties

- _ Colour temperatures 3,000, 4,000, 5,000 and 6,500 K
- _ Useful luminous flux 4,660 lm (20 x 1,120 mm) and 5,820 lm (20 x 1,400 mm) at 4,000 K, Irated and tp = 25 °C
- _ Efficacy of the LED module 170 lm/W at 4,000 K, Irated and tp = 25 °C
- _ High colour rendering index CRI > 80
- _ Small colour tolerance (MacAdam 3) ^①
- _ Small luminous flux tolerances

Mechanical properties

- _ Module dimension 20 x 1,120 mm and 20 x 1,400 mm
- _ Simple installation (e.g. screws)

System solution

- _ Combine Tridonic's LED modules and dimmable drivers to achieve an outstanding system efficacy (configuration possible via <https://setbuilder.tridonic.com/>)

^① Integral measurement over the complete module.

Website

<http://www.tridonic.com/28004147>

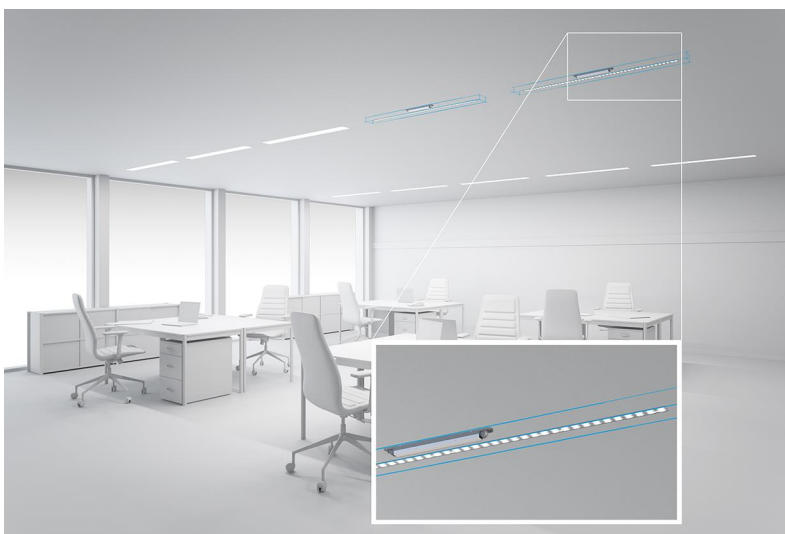

Spotlights



Downlights



Linear



Area



Floor | Wall



Free-standing



Street



Decorative



High bay

Technical data

Beam characteristic	120°
Ambient temperature t_a	-40 ... +65 °C
t_p rated	50 °C
t_c	90 °C
I_{rated}	300 mA
I_{max}	540 mA
Max. permissible LF current ripple	600 mA
Max. permissible peak current	900 mA / max. 10 ms
Max. working voltage for insulation [®]	400 V
Insulation test voltage	1.8 kV
CTI of the printed circuit board	≥ 600
Colour tolerance	3 SDCM
ESD classification	Severity level 2
Risk group (IEC 62471)	RG1
Classification acc. to IEC 62031	Built-in
Type of protection	IP00
Lumen maintenance L70B50	72,000 h
Guarantee (conditions at www.tridonic.com)	5 Year(s)

Approval marks**Standards**

IEC 62031, IEC 62471, IEC 61000-4-2, IEC 62778, IEC 61547

Specific technical data

Type	Article number	Photometric code	Useful luminous flux at $t_p = 25^\circ\text{C}$ ^③	Expected luminous flux at t_p rated ^④	Typ. forward current	Min. forward voltage at t_p rated	Max. forward voltage at $t_p = 25^\circ\text{C}$	Power consumption P_{on} at $t_p = 25^\circ\text{C}$	Efficacy of the module at $t_p = 25^\circ\text{C}$	Expected efficacy of the module at t_p rated	Colour rendering index CRI
Operating mode HE at 200 mA											
LLE 20x1120mm 4400lm 830 HV SNC3	28004147	830/359	-	2,910 lm	200 mA	82.7 V	91.6 V	-	-	165 lm/W	>>80
LLE 20x1120mm 4400lm 840 HV SNC3	28004148	840/359	-	3,060 lm	200 mA	82.7 V	91.6 V	-	-	173 lm/W	>>80
LLE 20x1120mm 4400lm 850 HV SNC3	28004149	850/359	-	3,100 lm	200 mA	82.7 V	91.6 V	-	-	175 lm/W	>>80
LLE 20x1120mm 4400lm 865 HV SNC3	28004150	865/359	-	3,060 lm	200 mA	82.7 V	91.6 V	-	-	173 lm/W	>>80
LLE 20x1400mm 5500lm 830 HV SNC3	28004151	830/359	-	3,640 lm	200 mA	103.4 V	114.5 V	-	-	165 lm/W	>>80
LLE 20x1400mm 5500lm 840 HV SNC3	28004152	840/359	-	3,820 lm	200 mA	103.4 V	114.5 V	-	-	173 lm/W	>>80
LLE 20x1400mm 5500lm 850 HV SNC3	28004153	850/359	-	3,870 lm	200 mA	103.4 V	114.5 V	-	-	175 lm/W	>>80
LLE 20x1400mm 5500lm 865 HV SNC3	28004154	865/359	-	3,820 lm	200 mA	103.4 V	114.5 V	-	-	173 lm/W	>>80
Operating mode HE at 250 mA											
LLE 20x1120mm 4400lm 830 HV SNC3	28004147	830/359	-	3,590 lm	250 mA	83.8 V	92.7 V	-	-	161 lm/W	>>80
LLE 20x1120mm 4400lm 840 HV SNC3	28004148	840/359	-	3,780 lm	250 mA	83.8 V	92.7 V	-	-	169 lm/W	>>80
LLE 20x1120mm 4400lm 850 HV SNC3	28004149	850/359	-	3,820 lm	250 mA	83.8 V	92.7 V	-	-	171 lm/W	>>80
LLE 20x1120mm 4400lm 865 HV SNC3	28004150	865/359	-	3,780 lm	250 mA	83.8 V	92.7 V	-	-	169 lm/W	>>80
LLE 20x1400mm 5500lm 830 HV SNC3	28004151	830/359	-	4,490 lm	250 mA	104.8 V	115.9 V	-	-	161 lm/W	>>80
LLE 20x1400mm 5500lm 840 HV SNC3	28004152	840/359	-	4,710 lm	250 mA	104.8 V	115.9 V	-	-	169 lm/W	>>80
LLE 20x1400mm 5500lm 850 HV SNC3	28004153	850/359	-	4,780 lm	250 mA	104.8 V	115.9 V	-	-	171 lm/W	>>80
LLE 20x1400mm 5500lm 865 HV SNC3	28004154	865/359	-	4,710 lm	250 mA	104.8 V	115.9 V	-	-	169 lm/W	>>80
Operating mode NM at 300 mA											
LLE 20x1120mm 4400lm 830 HV SNC3	28004147	830/359	4,440 lm	4,260 lm	300 mA	84.9 V	93.8 V	27.4 W	162 lm/W	157 lm/W	>>80
LLE 20x1120mm 4400lm 840 HV SNC3	28004148	840/359	4,660 lm	4,470 lm	300 mA	84.9 V	93.8 V	27.4 W	170 lm/W	165 lm/W	>>80
LLE 20x1120mm 4400lm 850 HV SNC3	28004149	850/359	4,720 lm	4,530 lm	300 mA	84.9 V	93.8 V	27.4 W	172 lm/W	167 lm/W	>>80
LLE 20x1120mm 4400lm 865 HV SNC3	28004150	865/359	4,660 lm	4,480 lm	300 mA	84.9 V	93.8 V	27.4 W	170 lm/W	165 lm/W	>>80
LLE 20x1400mm 5500lm 830 HV SNC3	28004151	830/359	5,550 lm	5,330 lm	300 mA	106.1 V	117.3 V	34.2 W	161 lm/W	157 lm/W	>>80
LLE 20x1400mm 5500lm 840 HV SNC3	28004152	840/359	5,820 lm	5,590 lm	300 mA	106.1 V	117.3 V	34.2 W	170 lm/W	165 lm/W	>>80
LLE 20x1400mm 5500lm 850 HV SNC3	28004153	850/359	5,900 lm	5,670 lm	300 mA	106.1 V	117.3 V	34.2 W	171 lm/W	167 lm/W	>>80
LLE 20x1400mm 5500lm 865 HV SNC3	28004154	865/359	5,820 lm	5,590 lm	300 mA	106.1 V	117.3 V	34.2 W	169 lm/W	165 lm/W	>>80
Operating mode HO at 350 mA											
LLE 20x1120mm 4400lm 830 HV SNC3	28004147	830/359	-	4,830 lm	350 mA	85.9 V	94.9 V	-	-	151 lm/W	>>80
LLE 20x1120mm 4400lm 840 HV SNC3	28004148	840/359	-	5,070 lm	350 mA	85.9 V	94.9 V	-	-	158 lm/W	>>80
LLE 20x1120mm 4400lm 850 HV SNC3	28004149	850/359	-	5,130 lm	350 mA	85.9 V	94.9 V	-	-	160 lm/W	>>80
LLE 20x1120mm 4400lm 865 HV SNC3	28004150	865/359	-	5,080 lm	350 mA	85.9 V	94.9 V	-	-	158 lm/W	>>80
LLE 20x1400mm 5500lm 830 HV SNC3	28004151	830/359	-	6,040 lm	350 mA	107.4 V	118.6 V	-	-	151 lm/W	>>80
LLE 20x1400mm 5500lm 840 HV SNC3	28004152	840/359	-	6,340 lm	350 mA	107.4 V	118.6 V	-	-	158 lm/W	>>80
LLE 20x1400mm 5500lm 850 HV SNC3	28004153	850/359	-	6,420 lm	350 mA	107.4 V	118.6 V	-	-	160 lm/W	>>80
LLE 20x1400mm 5500lm 865 HV SNC3	28004154	865/359	-	6,340 lm	350 mA	107.4 V	118.6 V	-	-	158 lm/W	>>80
Operating mode HO at 400 mA											
LLE 20x1120mm 4400lm 830 HV SNC3	28004147	830/359	-	5,250 lm	400 mA	86.9 V	96.0 V	-	-	142 lm/W	>>80
LLE 20x1120mm 4400lm 840 HV SNC3	28004148	840/359	-	5,520 lm	400 mA	86.9 V	96.0 V	-	-	149 lm/W	>>80
LLE 20x1120mm 4400lm 850 HV SNC3	28004149	850/359	-	5,580 lm	400 mA	86.9 V	96.0 V	-	-	151 lm/W	>>80
LLE 20x1120mm 4400lm 865 HV SNC3	28004150	865/359	-	5,520 lm	400 mA	86.9 V	96.0 V	-	-	149 lm/W	>>80
LLE 20x1400mm 5500lm 830 HV SNC3	28004151	830/359	-	6,570 lm	400 mA	108.7 V	119.9 V	-	-	142 lm/W	>>80
LLE 20x1400mm 5500lm 840 HV SNC3	28004152	840/359	-	6,890 lm	400 mA	108.7 V	119.9 V	-	-	149 lm/W	>>80
LLE 20x1400mm 5500lm 850 HV SNC3	28004153	850/359	-	6,990 lm	400 mA	108.7 V	119.9 V	-	-	151 lm/W	>>80
LLE 20x1400mm 5500lm 865 HV SNC3	28004154	865/359	-	6,890 lm	400 mA	108.7 V	119.9 V	-	-	149 lm/W	>>80
Operating mode HO at 450 mA											
LLE 20x1120mm 4400lm 830 HV SNC3	28004147	830/359	-	5,590 lm	450 mA	84.3 V	103.8 V	-	-	133 lm/W	>>80
LLE 20x1120mm 4400lm 840 HV SNC3	28004148	840/359	-	5,870 lm	450 mA	84.3 V	103.8 V	-	-	139 lm/W	>>80
LLE 20x1120mm 4400lm 850 HV SNC3	28004149	850/359	-	5,940 lm	450 mA	84.3 V	103.8 V	-	-	141 lm/W	>>80
LLE 20x1120mm 4400lm 865 HV SNC3	28004150	865/359	-	5,870 lm	450 mA	84.3 V	103.8 V	-	-	139 lm/W	>>80
LLE 20x1400mm 5500lm 830 HV SNC3	28004151	830/359	-	6,990 lm	450 mA	105.3 V	129.8 V	-	-	133 lm/W	>>80
LLE 20x1400mm 5500lm 840 HV SNC3	28004152	840/359	-	7,330 lm	450 mA	105.3 V	129.8 V	-	-	139 lm/W	>>80
LLE 20x1400mm 5500lm 850 HV SNC3	28004153	850/359	-	7,430 lm	450 mA	105.3 V	129.8 V	-	-	141 lm/W	>>80
LLE 20x1400mm 5500lm 865 HV SNC3	28004154	865/359	-	7,330 lm	450 mA	105.3 V	129.8 V	-	-	139 lm/W	>>80
Operating mode HO at 500 mA											
LLE 20x1120mm 4400lm 830 HV SNC3	28004147	830/359	-	5,860 lm	500 mA	85.1 V	104.9 V	-	-	124 lm/W	>>80
LLE 20x1120mm 4400lm 840 HV SNC3	28004148	840/359	-	6,150 lm	500 mA	85.1 V	104.9 V	-	-	130 lm/W	>>80
LLE 20x1120mm 4400lm 850 HV SNC3	28004149	850/359	-	6,230 lm	500 mA	85.1 V	104.9 V	-	-	132 lm/W	>>80
LLE 20x1120mm 4400lm 865 HV SNC3	28004150	865/359	-	6,160 lm	500 mA	85.1 V	104.9 V	-	-	130 lm/W	>>80
LLE 20x1400mm 5500lm 830 HV SNC3	28004151	830/359	-	7,330 lm	500 mA	106.4 V	131.1 V	-	-	124 lm/W	>>80
LLE 20x1400mm 5500lm 840 HV SNC3	28004152	840/359	-	7,690 lm	500 mA	106.4 V	131.1 V	-	-	130 lm/W	>>80
LLE 20x1400mm 5500lm 850 HV SNC3	28004153	850/359	-	7,790 lm	500 mA	106.4 V	131.1 V	-	-	132 lm/W	>>80
LLE 20x1400mm 5500lm 865 HV SNC3	28004154	865/359	-	7,690 lm	500 mA	106.4 V	131.1 V	-	-	130 lm/W	>>80

② For details see 3.1 Electrical supply/choice of LED driver in data sheet.

③ Tolerance of useful light flux - 0 % / + 15 %. Measurement uncertainty ± 10 %.

④ Tolerance of expected light flux - 0 % / + 15 %. Measurement uncertainty ± 10 %. Based on calculation.

⑤ Tolerance of power consumption P_{on} ± 10 %. Measurement uncertainty ± 5 %.

LINEAR COVER LLE

Accessory

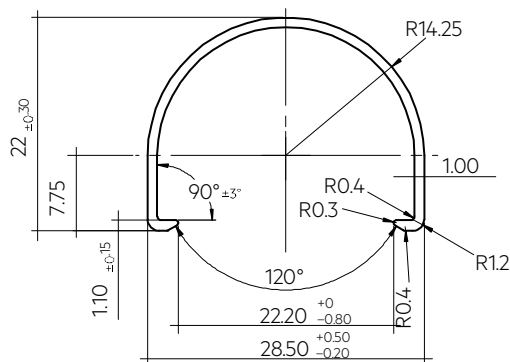

Product description

- _ LINEAR COVER for LLE
- _ Protection against direct touch for non-SELV applications (recommendation LLE 20: use all fixing points and screwed Endcap, recommendation LLE 24: use all fixing points)
- _ Fast snap on mounting on to LLE 20: with M4 screws and plastic washers, to LLE 24: with clips or plastic washers
- _ High transmission: transparent, semi-transparent and diffuse
- _ Material: PMMA
- _ Tolerances: ± 1 mm for 597 mm length (ends finished), + 10 mm from length 1,150 mm (ends raw)

Website

<http://www.tridonic.com/28000338>



Ordering data

Type	Article number	Colour	Length L	Efficiency	Packaging, carton	Weight per pc.
LINEAR COVER SY Transparent 1600mm	28000338	Transparent	1,600 mm	94 %	12 pc(s).	0.272 kg
ACL LINEAR COVER 20x1450mm FROSTED	28004145	Semi-transparent	1,450 mm	82 %	50 pc(s).	0.343 kg
ACL LINEAR COVER 20x1150mm FROSTED	28003527	Semi-transparent	1,150 mm	82 %	50 pc(s).	0.087 kg
LINEAR COVER SY Frosted 1800mm	28000437	Semi-transparent	1,800 mm	87 %	12 pc(s).	0.308 kg
LINEAR COVER SY Frosted 1600mm	28000339	Semi-transparent	1,600 mm	87 %	12 pc(s).	0.272 kg
LINEAR COVER SY Frosted 1500mm	28000435	Semi-transparent	1,500 mm	87 %	12 pc(s).	0.244 kg
LINEAR COVER SY Frosted 1200mm	28000422	Semi-transparent	1,200 mm	87 %	12 pc(s).	0.205 kg
LINEAR COVER SY Frosted 597mm	28000340	Semi-transparent	597 mm	87 %	12 pc(s).	0.102 kg
LINEAR COVER SY Diffuse 1800mm	28000438	Diffuse	1,800 mm	76 %	12 pc(s).	0.308 kg
LINEAR COVER SY Diffuse 1600mm	28000341	Diffuse	1,600 mm	76 %	12 pc(s).	0.272 kg
LINEAR COVER SY Diffuse 1500mm	28000436	Diffuse	1,500 mm	76 %	12 pc(s).	0.257 kg
LINEAR COVER SY Diffuse 1200mm	28000434	Diffuse	1,200 mm	76 %	12 pc(s).	0.205 kg
LINEAR COVER SY Diffuse 597mm	28000342	Diffuse	597 mm	76 %	12 pc(s).	0.102 kg

ACL ENDCAP LLE

Accessory

**Product description**

- _ ENDCAP for LLE
- _ PUSH-FIX: Fast snap on mounting (sheet thickness 0.5 – 1.0 mm), for drilling hole 4 mm
- _ SCREW-FIX: Screw mounting with EJOT Delta PT WN 5451 30x8 (not included), tightening torque 0.7 Nm
- _ Clip made of polycarbonate

Website

<http://www.tridonic.com/28004379>

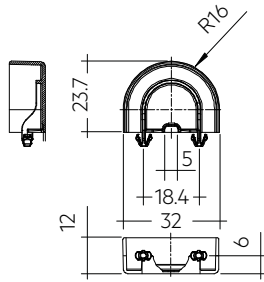
**Ordering data**

Type	Article number	Colour	Packaging, carton	Weight per pc.
ACL ENDCAP LLE20 PUSH-FIX	28004379	White	1,500 pc(s).	0.003 kg
ACL ENDCAP LLE24 PUSH-FIX	28001037	White	480 pc(s).	0.003 kg
ACL ENDCAP LLE24 SCREW-FIX	28002315	White	480 pc(s).	0.003 kg

ACL LINEAR LENS 24mm

Accessory

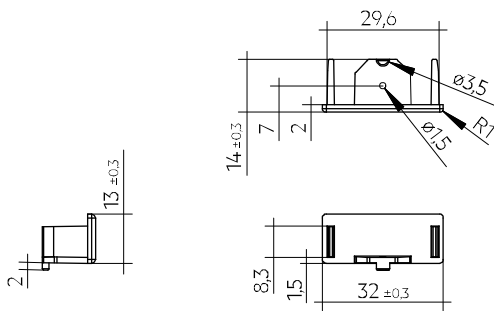
**Product description LINEAR LENS**

- _ Linear lens for LLE 20 / 24
- _ Available with different beam characteristics
- _ Protection against direct touch for non-SELV applications (recommendation: use all fixing points)
- _ Fast snap on mounting on to LLE 20: with M4 screws and plastic washers, to LLE 24: with clips or plastic washers
- _ Recommendation: Fastening with screws and plastic washers, see 2.3 Heat sink specifications in data sheet
- _ Material: PMMA
- _ Available lengths: 1,200, 1,500 and 1,800 mm, Tolerance: + 10 mm (ends raw)
- _ Max. permissible temperature 80 °C
- _ Photometric data available on website

Product description Endcap

- _ ENDCAP for LINEAR LENS 24mm INTENSE, ASY and DASY
- _ Mounting by clipping in and screwing from below using screw EJOT Delta PT WN 5451 20x4, tightening torque 0.7 Nm
- _ Made of Polyamide UL94 V0

Website

<http://www.tridonic.com/28001428>

**Ordering data**

Type	Article number	Length L	Beam characteristic	Efficiency	Packaging, carton	Weight per pc.
ACL LINEAR LENS 24x1200mm 60°	28001428	1,200 mm	60°	97 %	21 pc(s).	0.196 kg
ACL LINEAR LENS 24x1200mm 90°	28001429	1,200 mm	90°	97 %	21 pc(s).	0.165 kg
ACL LINEAR LENS 24x1500mm 60°	28000953	1,500 mm	60°	97 %	21 pc(s).	0.261 kg
ACL LINEAR LENS 24x1500mm 90°	28000955	1,500 mm	90°	97 %	21 pc(s).	0.221 kg
ACL LINEAR LENS 24x1200mm ASY	28002030	1,200 mm	asymmetric	95 %	18 pc(s).	0.250 kg
ACL LINEAR LENS 24x1500mm ASY	28002031	1,500 mm	asymmetric	95 %	18 pc(s).	0.312 kg
ACL LINEAR LENS 24x1800mm ASY	28002032	1,800 mm	asymmetric	95 %	18 pc(s).	0.375 kg
ACL LINEAR LENS 24x1200mm DASY	28002033	1,200 mm	double asymmetric	92 %	18 pc(s).	0.249 kg
ACL LINEAR LENS 24x1500mm DASY	28002034	1,500 mm	double asymmetric	92 %	18 pc(s).	0.311 kg
ACL LINEAR LENS 24x1800mm DASY	28002035	1,800 mm	double asymmetric	92 %	18 pc(s).	0.373 kg
ACL Endcap LENS 24mm PSF	28002669	-	-	-	3,600 pc(s).	0.003 kg

1. Standards

IEC 62031
IEC 62471
IEC 61000-4-2
IEC 62778
IEC 61547

1.1 Photometric code

Key for photometric code, e. g. 830 / 349

1 st digit	2 nd + 3 rd digit	4 th digit	5 th digit	6 th digit		
Code	Colour temperature in Kelvin x 100	MacAdam initial	MacAdam after 25% of the lifetime (max.6000h)	Luminous flux after 25% of the lifetime (max.6000h)		
7				70 – 79	Code	Luminous flux
8				80 – 89	7	≥ 70 %
9				≥90	8	≥ 80 %
				9	≥ 90 %	

1.2 Energy classification

Type	Colour temperature	Forward current	Energy classification	Energy consumption
LLE 20x1120mm 4400lm 830 HV SNC3	3,000 K	300 mA	D	28 kWh / 1,000 h
LLE 20x1120mm 4400lm 840 HV SNC3	4,000 K	300 mA	D	28 kWh / 1,000 h
LLE 20x1120mm 4400lm 850 HV SNC3	5,000 K	300 mA	D	28 kWh / 1,000 h
LLE 20x1120mm 4400lm 865 HV SNC3	6,500 K	300 mA	D	28 kWh / 1,000 h
LLE 20x1400mm 5500lm 830 HV SNC3	3,000 K	300 mA	D	35 kWh / 1,000 h
LLE 20x1400mm 5500lm 840 HV SNC3	4,000 K	300 mA	D	35 kWh / 1,000 h
LLE 20x1400mm 5500lm 850 HV SNC3	5,000 K	300 mA	D	35 kWh / 1,000 h
LLE 20x1400mm 5500lm 865 HV SNC3	6,500 K	300 mA	D	35 kWh / 1,000 h

Energy label and further information at www.tridonic.com in the certificates tab of the corresponding product page and at the EPREL data base <https://eprel.ec.europa.eu/>

2. Thermal details

2.1 tc point, ambient temperature and lifetime

The temperature at tp reference point is crucial for the light output and lifetime of a LED product.

For LLE a tp temperature of 50 °C has to be complied in order to achieve an optimum between heat sink requirements, light output and lifetime.

Compliance with the maximum permissible reference temperature at the tc point must be checked under operating conditions in a thermally stable state. The maximum value must be determined under worst-case conditions for the relevant application.

The tc and tp temperature of LED modules from Tridonic are measured at the same reference point.

2.2 Storage and humidity

Storage temperature	-40 ... +100 °C
---------------------	-----------------

Operation only in non condensing environment.

Humidity during processing of the module should be between 30 to 70 %.

2.3 Heat sink values

LLE 24x1120mm 4400lm SNC3

ta	tp	Forward current	R _{th, hs-a}	Cooling area
25 °C	50 °C	300 mA	1.72 K/W	389 cm ²
25 °C	50 °C	500 mA	0.79 K/W	843 cm ²
35 °C	50 °C	300 mA	0.93 K/W	714 cm ²
35 °C	50 °C	500 mA	0.38 K/W	1,758 cm ²
40 °C	50 °C	300 mA	0.54 K/W	1,227 cm ²
40 °C	50 °C	500 mA	0.17 K/W	3,843 cm ²

LLE 24x1400mm 5500lm SNC3

ta	tp	Forward current	R _{th, hs-a}	Cooling area
25 °C	50 °C	300 mA	1.36 K/W	491 cm ²
25 °C	50 °C	500 mA	0.63 K/W	1,061 cm ²
35 °C	50 °C	300 mA	0.74 K/W	902 cm ²
35 °C	50 °C	500 mA	0.30 K/W	2,217 cm ²
40 °C	50 °C	300 mA	0.43 K/W	1,554 cm ²
40 °C	50 °C	500 mA	0.14 K/W	4,866 cm ²

Notes

The actual cooling surface can differ because of the material, the structural shape, outside influences and the installation situation. Depending on the heat sink a heat conducting paste or heat conducting film might be necessary to keep the specified tp temperature.

3. Installation / wiring

3.1 Electrical supply/choice of LED driver

LLE modules from Tridonic are not protected against overvoltages, overcurrents, overloads or short-circuit currents. Safe and reliable operation can only be guaranteed in conjunction with a LED driver which complies with the relevant standards. The use of LED driver from Tridonic in combination with LLE modules guarantees the necessary protection for safe and reliable operation.

If a LED driver other than Tridonic is used, it must provide the following protection:

- Short-circuit protection
- Overload protection
- Overtemperature protection



LLE modules must be supplied by a constant current LED driver. Operation with a constant voltage LED driver will lead to an irreversible damage of the module.

Wrong polarity can damage the LLE.

The LLE module is designed for serial wiring.

LLE can be operated either from SELV LED drivers or from LED drivers with LV output voltage.



LLE are basic insulated up to 400 V (if mounted with M4 screws with head diameter 7 mm in combination with plastic washers on a flat surface) against ground and can be mounted directly on earthed metal parts of the luminaire. If the max. output voltage of the LED driver (also against earth) is above 400 V, an additional insulation between LED module and heat sink is required (for example by insulated thermal pads) or by a suitable luminaire construction. At voltages > 60 V an additional protection against direct touch (test finger) to the light emitting side of the module has to be guaranteed. This is typically achieved by means of a non removable light distributor over the module.

The module can be mounted with BJB P2F 28.903 fasteners.

Only the green marked mounting holes may be used for this purpose.

The manufacturer's mounting instructions must be observed.

Max. working voltage for insulation when mounted with BJB P2F 28.903 on a flat surface is 300 V.

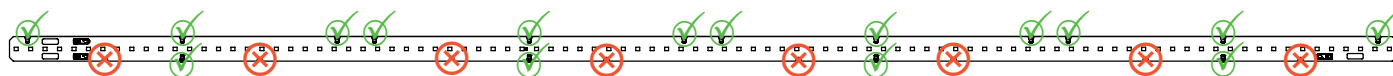

Protection against accidental contact of live parts and compliance with clearances and creepage distances must be ensured in the final application.

3.3 Wiring

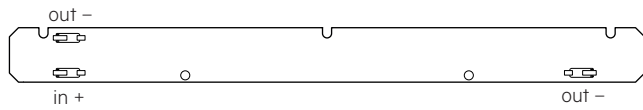

Wiring example

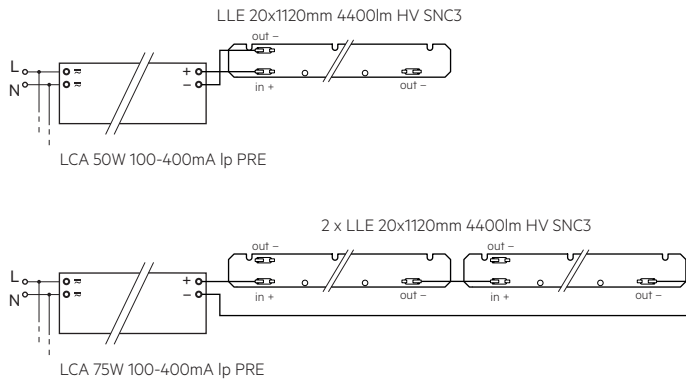

3.4 Wiring type and cross section

For wiring use stranded wire with ferrules or solid wire from 0.2 to 0.75 mm². For the push-wire connection you have to strip the insulation (8–9 mm).

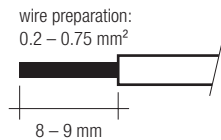

To remove the wires use a suitabel tool (e.g. Microcon release pin) or through twist and pull.

3.5 Mounting instruction

! None of the components of the LLE (substrate, LED, electronic components etc.) may be exposed to tensile or compressive stresses.

Max. torque for fixing: 0.5 Nm.

The LED modules are mounted onto a heat sink with min. 12 screws per module or ACL CLIP 4.3mm.

! Chemical substance may harm the LED module. Chemical reactions could lead to colour shift, reduced luminous flux or a total failure of the module caused by corrosion of electrical connections.

Materials which are used in LED applications (e.g. sealings, adhesives) must not produce dissolver gas. They must not be condensation curing based, acetate curing based or contain sulfur, chlorine or phthalate. Avoid corrosive atmosphere during usage and storage.

3.6 EOS/ESD safety guidelines

! The device / module contains components that are sensitive to electrostatic discharge and may only be installed in the factory and on site if appropriate EOS/ESD protection measures have been taken. No special measures need be taken for devices/modules with enclosed casings (contact with the pc board not possible), just normal installation practice. Please note the requirements set out in the document EOS / ESD guidelines (Guideline_EOS_ESD.pdf) at: <http://www.tridonic.com/esd-protection>

4. Lifetime

4.1 Lifetime, lumen maintenance and failure rate

The light output of an LED module decreases over the lifetime, this is characterized with the L value.

L70 means that the LED module will give 70 % of its initial luminous flux. This value is always related to the number of operation hours and therefore defines the lifetime of an LED module.

As the L value is a statistical value and the lumen maintenance may vary over the delivered LED modules.

The B value defines the amount of modules which are below the specific L value, e.g. L70B10 means 10 % of the LED modules are below 70 % of the initial luminous flux, respectively 90 % will be above 70 % of the initial value. In addition the percentage of failed modules (fatal failure) is characterized by the C value.

The F value is the combination of the B and C value. That means for F degradation and complete failures are considered, e.g. L70F10 means 10 % of the LED modules may fail or be below 70 % of the initial luminous flux.

4.2 Lumen maintenance for LLE

Forward current	tp temperature	L90 / F10 L90 / F50 L80 / F10 L80 / F50 L70 / F10 L70 / F50					
		300 mA	40 °C	42,000 h	58,000 h	>72,000 h	>72,000 h
	45 °C	41,000 h	56,000 h	>72,000 h	>72,000 h	>72,000 h	>72,000 h
	50 °C	40,000 h	54,000 h	>72,000 h	>72,000 h	>72,000 h	>72,000 h
	55 °C	40,000 h	52,000 h	>72,000 h	>72,000 h	>72,000 h	>72,000 h
	60 °C	39,000 h	51,000 h	>72,000 h	>72,000 h	>72,000 h	>72,000 h
	65 °C	38,000 h	49,000 h	>72,000 h	>72,000 h	>72,000 h	>72,000 h
	70 °C	37,000 h	48,000 h	>72,000 h	>72,000 h	>72,000 h	>72,000 h
	75 °C	36,000 h	46,000 h	>72,000 h	>72,000 h	>72,000 h	>72,000 h
	80 °C	35,000 h	45,000 h	>72,000 h	>72,000 h	>72,000 h	>72,000 h
	85 °C	34,000 h	44,000 h	70,000 h	>72,000 h	>72,000 h	>72,000 h

4.3 Switching capability

100,000 cycles

Tridonic test according to IEC 62717 Cl 10.3.3
30 s on / 30 s off at I_{max}

5. Electrical values

5.1 Declaration of electrical parameters

I_{rated} ... Nominal operating current the module is designed for.

I_{max} ... Max. permissible continuous operating current incl. The tolerances of the LED driver.

Max. permissible LF current ripple ... Max. output current of the LED driver incl. Tolerances and LF current ripple must not exceed this value.

Max. permissible peak current ... The max. output peak current of the LED driver must not exceed this value.

5.2 Typ. forward voltage vs. forward current

LLE 20x1120mm 4400lm 8xx HV SNC3

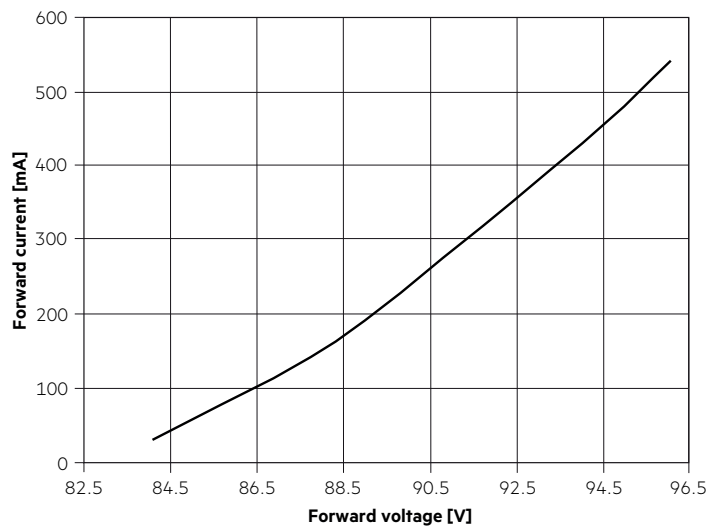

LLE 24x1400mm 5500lm 8xx HV SNC3

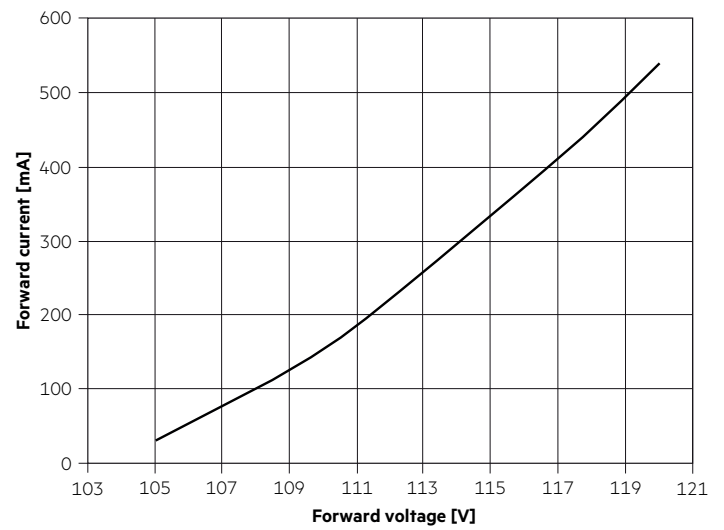

5.3 Forward voltage vs. t_c temperature

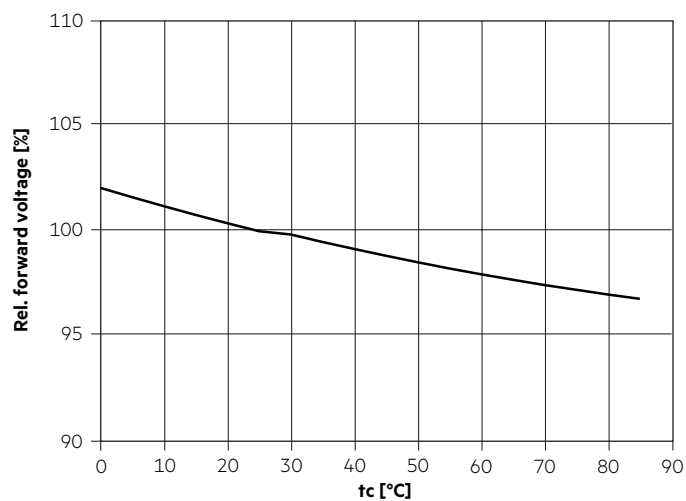

The diagrams are based on statistic values.
The real values can be different.

6. Photometric characteristics

6.1 Coordinates and tolerances according to CIE 1931

The specified colour coordinates are integral measured by current impulse of 450 mA and a duration of 100 ms.
 The ambient temperature of the measurement is $t_a = 25^\circ\text{C}$.
 The measurement tolerance of the colour coordinates are ± 0.01 .

3,000 K

	x0	y0
Centre	0.4338	0.4030

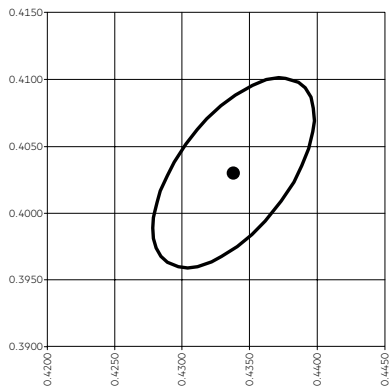

— MacAdam Ellipse: 3SDCM

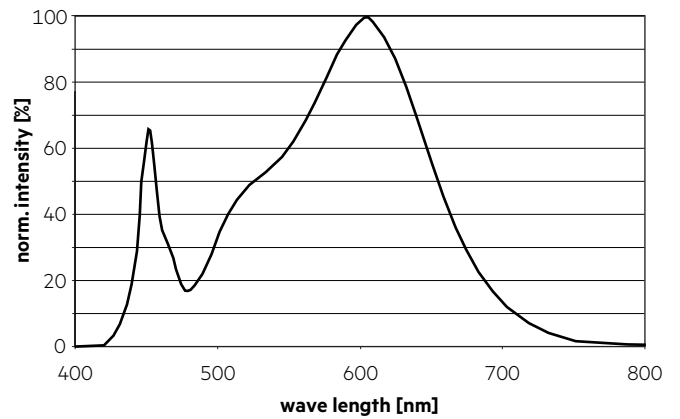

4,000 K

	x0	y0
Center	0.3818	0.3797

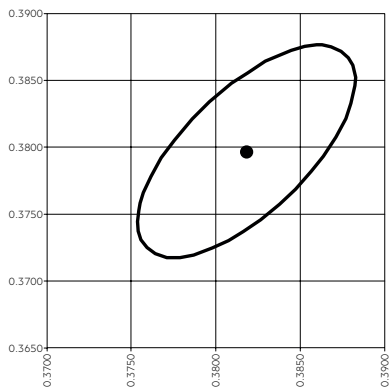

— MacAdam Ellipse: 3SDCM

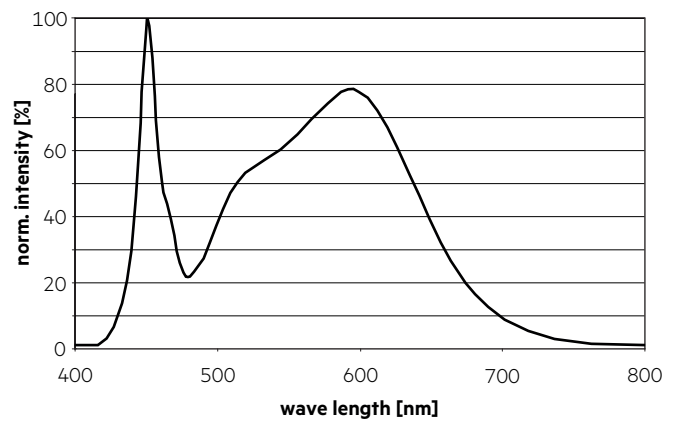

5,000 K

	x0	y0
Center	0.3447	0.3553

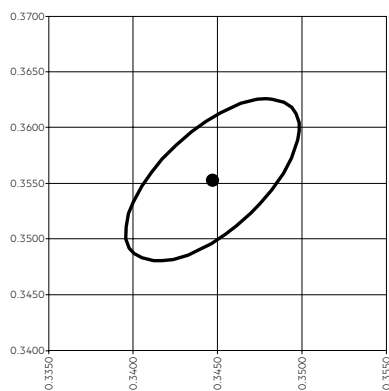

— MacAdam Ellipse: 3SDCM

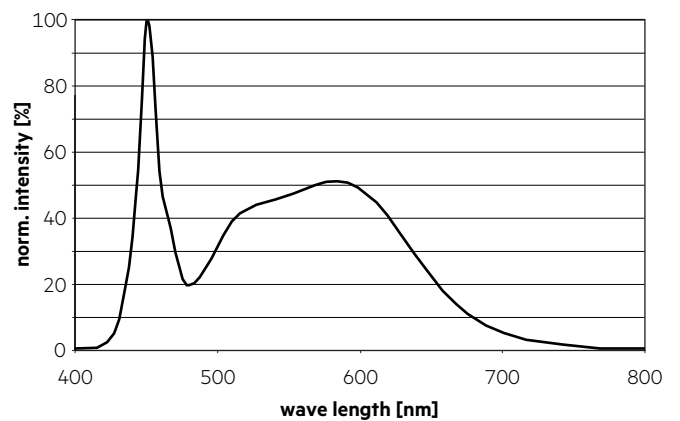

6,500 K

	x0	y0
Center	0.3123	0.3282

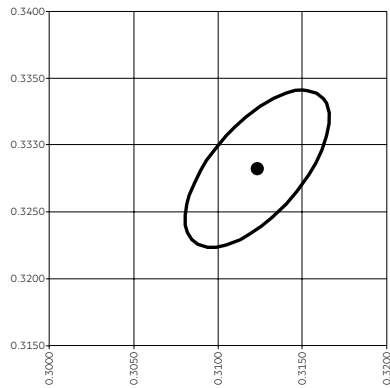

— MacAdam Ellipse: 3SDCM

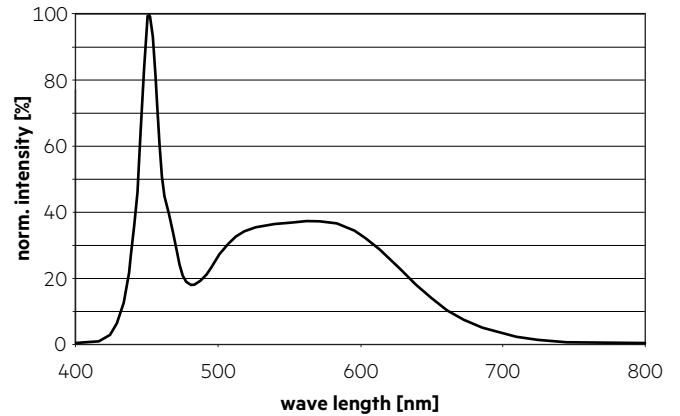

6.2 Light distribution

The optical design of the LLE product line ensures optimum homogeneity for the light distribution.

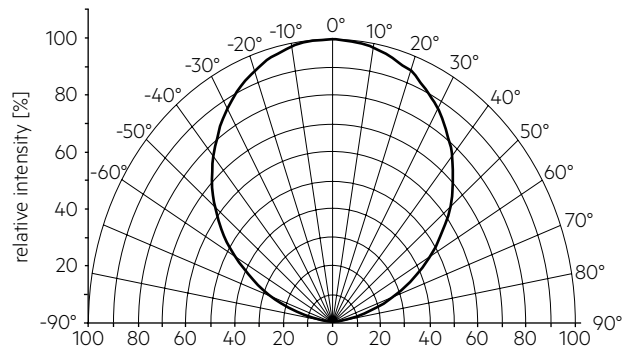

The colour temperature is measured integral over the complete module. The single LED light points can have deviations in the colour coordinates within MacAdam 5. To ensure an ideal mixture of colours and a homogeneous light distribution a suitable optic (e. g. PMMA diffuser) and a sufficient spacing between module and optic (typ. 4 cm) should be used.

6.4 Relative luminous flux vs. operating current

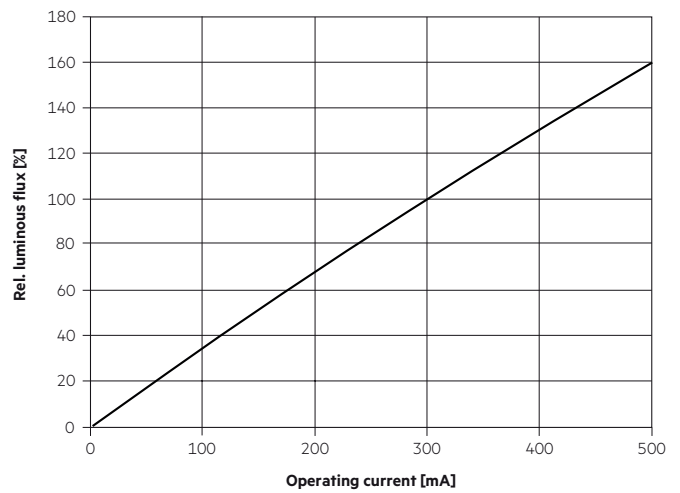

The diagrams are based on statistic values. The real values can be different.

6.3 Relative luminous flux vs. tc temperature

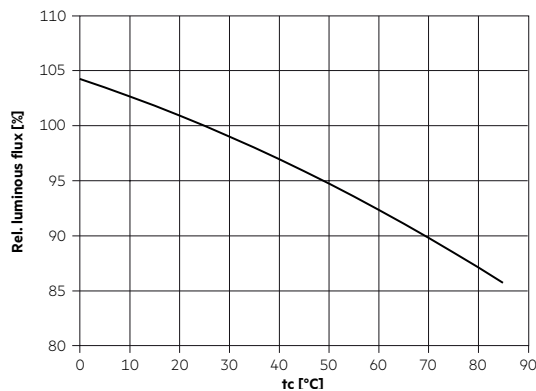

7. Miscellaneous

7.1 Additional information

Additional technical information at www.tridonic.com → Technical Data

Guarantee conditions at www.tridonic.com → Services

Lifetime declarations are informative and represent no warranty claim.