

Module LLE 20mm 750lm 927-965 CRI90 DL PRE

Modules LLE premium

**Product description**

- _ Linear Tunable White LED module
- _ Ideal for linear luminaires
- _ Push terminals for quick and simple wiring
- _ Design for LEDiL DAISY-MINI and KHATOD ANDROMEDA portfolio
- _ HE ... High Efficiency, NM ... Nominal Mode, HO ... High Output
- _ Orders only in full carton quantities.
- _ Long lifetime up to 102,000 hours
- _ 5 years guarantee (conditions at <https://www.tridonic.com/en/int/services/manufacturer-guarantee-conditions>)

Optical properties

- _ Colour temperatures 2,700 K to 6,500 K
- _ Efficacy up to 195 lm/W
- _ High colour rendering index CRI > 90
- _ High colour consistency (MacAdam 3)
- _ Small luminous flux tolerances

Mechanical properties

- _ Module dimension 20 x 280 mm
- _ Simple installation of lens and module with M3 screws

System solution

- _ Integrate compatible partner products into your final system solution:
<https://www.tridonic.com/en/int/products/accessories#partner>

Website<http://www.tridonic.com/28006240>

Linear



High bay



Decorative



Downlights



Spotlights



Free-standing



Area



Floor | Wall



Street

Specific technical data

Type	Article number	Colour temperature	Photometric code	Useful luminous flux ^① at tp = 25 °C	Expected luminous flux at tp rated	Typ. forward current	Min. forward voltage at tp rated	Max. forward voltage at tp = 25 °C	Power consumption P _{on} at tp = 25 °C	Efficacy of the module at tp = 25 °C	Expected efficacy of the module at tp rated	Colour rendering index CRI
Operating mode NM at 50 mA												
LLE 20x280mm 750lm 927-965 DL PRE	28006240	2,700 K	927/359	370 lm	350 lm	50 mA	35.7 V	38.5 V	1.9 W	195 lm/W	191 lm/W	>90
LLE 20x280mm 750lm 927-965 DL PRE	28006240	3,000 K	930/359	-	346 lm	50 mA	35.7 V	38.5 V	-	-	189 lm/W	>90
LLE 20x280mm 750lm 927-965 DL PRE	28006240	4,000 K	940/359	-	373 lm	50 mA	35.7 V	38.5 V	-	-	204 lm/W	>90
LLE 20x280mm 750lm 927-965 DL PRE	28006240	5,000 K	950/359	-	373 lm	50 mA	35.7 V	38.5 V	-	-	204 lm/W	>90
LLE 20x280mm 750lm 927-965 DL PRE	28006240	6,500 K	965/359	-	370 lm	50 mA	35.7 V	38.5 V	-	-	202 lm/W	>90
Operating mode HO at 100 mA												
LLE 20x280mm 750lm 927-965 DL PRE	28006240	2,700 K	927/359	-	692 lm	100 mA	36.7 V	39.5 V	-	-	184 lm/W	>90
LLE 20x280mm 750lm 927-965 DL PRE	28006240	3,000 K	930/359	-	685 lm	100 mA	36.7 V	39.5 V	-	-	182 lm/W	>90
LLE 20x280mm 750lm 927-965 DL PRE	28006240	4,000 K	940/359	-	738 lm	100 mA	36.7 V	39.5 V	-	-	196 lm/W	>90
LLE 20x280mm 750lm 927-965 DL PRE	28006240	5,000 K	950/359	-	738 lm	100 mA	36.7 V	39.5 V	-	-	196 lm/W	>90
LLE 20x280mm 750lm 927-965 DL PRE	28006240	6,500 K	965/359	-	731 lm	100 mA	36.7 V	39.5 V	-	-	194 lm/W	>90
Operating mode HO at 150 mA												
LLE 20x280mm 750lm 927-965 DL PRE	28006240	2,700 K	927/359	-	1,016 lm	150 mA	37.5 V	40.4 V	-	-	176 lm/W	>90
LLE 20x280mm 750lm 927-965 DL PRE	28006240	3,000 K	930/359	-	1,005 lm	150 mA	37.5 V	40.4 V	-	-	174 lm/W	>90
LLE 20x280mm 750lm 927-965 DL PRE	28006240	4,000 K	940/359	-	1,083 lm	150 mA	37.5 V	40.4 V	-	-	188 lm/W	>90
LLE 20x280mm 750lm 927-965 DL PRE	28006240	5,000 K	950/359	-	1,083 lm	150 mA	37.5 V	40.4 V	-	-	188 lm/W	>90
LLE 20x280mm 750lm 927-965 DL PRE	28006240	6,500 K	965/359	-	1,073 lm	150 mA	37.5 V	40.4 V	-	-	186 lm/W	>90

① Values for each channel.

② Measured at operating mode HO.

③ Tolerance of useful light flux - 0 % / + 15 %. Measurement uncertainty ± 10 %.

1. Standards

IEC 62031
IEC 62471
IEC 61000-4-2
IEC 62778
IEC 61547
UL 8750

1.1 Photometric code

Key for photometric code, e. g. 830 / 349

1 st digit		2 nd + 3 rd digit	4 th digit	5 th digit	6 th digit	
Code	CRI	Colour temperature in Kelvin x 100	MacAdam initial	MacAdam after 25% of the lifetime (max.6000h)	Luminous flux after 25% of the lifetime (max.6000h)	
7	70 – 79				Code	Luminous flux
8	80 – 89				7	≥ 70 %
9	≥90				8	≥ 80 %
				9	≥ 90 %	

1.2 Energy classification

Type	Colour temperature	Forward current	Energy classification	Energy consumption
LLE 20x280mm 750lm 927-965 DL PRE	2,700 K	50 mA	C	2 kWh / 1,000 h

Energy label and further information at www.tridonic.com in the certificates tab of the corresponding product page and at the EPREL data base <https://eprel.ec.europa.eu/>

2. Thermal details

2.1 tc point, ambient temperature and lifetime

The temperature at tp reference point is crucial for the light output and lifetime of a LED product.

For LLE a tp temperature of 65 °C has to be complied in order to achieve an optimum between heat sink requirements, light output and lifetime.

Compliance with the maximum permissible reference temperature at the tc point must be checked under operating conditions in a thermally stable state. The maximum value must be determined under worst-case conditions for the relevant application.

The tc and tp temperature of LED modules from Tridonic are measured at the same reference point.

2.2 Storage and humidity

Storage temperature	-40 ... +80 °C
---------------------	----------------

Operation only in non condensing environment.
Humidity during processing of the module should be between 30 to 70 %.

2.3 Heat sink values

LLE 20x280mm 750lm DL PRE

ta	tp	Forward current	R _{th, hs-a}	Cooling area
25 °C	65 °C	100 mA	26.67 K/W	25 cm ²
25 °C	65 °C	360 mA	4.92 K/W	136 cm ²
35 °C	65 °C	100 mA	19.79 K/W	34 cm ²
35 °C	65 °C	360 mA	3.47 K/W	192 cm ²
40 °C	65 °C	100 mA	16.34 K/W	41 cm ²
40 °C	65 °C	360 mA	2.75 K/W	242 cm ²
45 °C	65 °C	100 mA	12.90 K/W	52 cm ²
45 °C	65 °C	360 mA	2.03 K/W	328 cm ²
50 °C	65 °C	100 mA	9.46 K/W	70 cm ²
50 °C	65 °C	360 mA	1.31 K/W	510 cm ²
55 °C	65 °C	100 mA	6.02 K/W	111 cm ²
55 °C	65 °C	360 mA	0.59 K/W	1137 cm ²

Notes

The actual cooling surface can differ because of the material, the structural shape, outside influences and the installation situation. Depending on the heat sink a heat conducting paste or heat conducting film might be necessary to keep the specified tp temperature.

3. Installation / wiring

3.1 Electrical supply/choice of LED driver

LLE modules from Tridonic are not protected against overvoltages, overcurrents, overloads or short-circuit currents. Safe and reliable operation can only be guaranteed in conjunction with a LED driver which complies with the relevant standards. The use of LED driver from Tridonic in combination with LLE modules guarantees the necessary protection for safe and reliable operation.

If a LED driver other than Tridonic is used, it must provide the following protection:

- Short-circuit protection
- Overload protection
- Overtemperature protection



LLE modules must be supplied by a constant current LED driver. Operation with a constant voltage LED driver will lead to an irreversible damage of the module.

Wrong polarity can damage the LLE.

With parallel wiring tolerance-related differences in output are possible (thermal stress of the module) and can cause differences in brightness.

If a wire breaks or a complete module fails then the current passing through the other module increases. This may reduce its life considerably.

The max. permissible output current of the LED driver for parallel wiring is 3 A.

LLE have to be operated with SELV LED drivers.



LLE are basic insulated up to 60 V SELV (if mounted with M3 screws in combination with a lens like LEDiL DAISY) against ground and can be mounted directly on earthed metal parts of the luminaire. If the max. output voltage of the LED driver (also against earth) is above 60 V SELV, an additional insulation between LED module and heat sink is required (for example by insulated thermal pads) or by a suitable luminaire construction.

3.2 Wiring

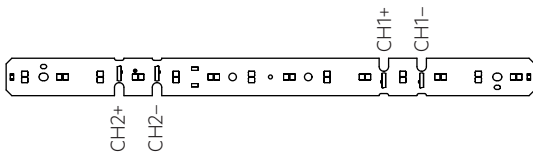

Wiring examples

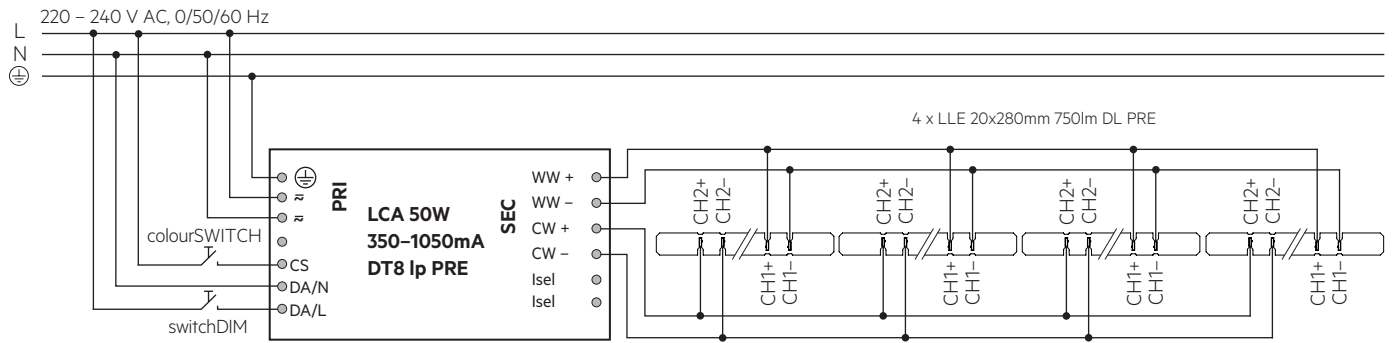

3.3 Wiring type and cross section

For wiring use solid wire from 0.2 – 0.75 mm² (AWG24–18).
 For the push-wire connection you have to strip the insulation (7.5–9.5 mm).

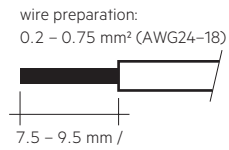

Release the wires by pressing it.

3.4 Mounting instruction



None of the components of the LLE (substrate, LED, electronic components etc.) may be exposed to tensile or compressive stresses.

Max. torque for fixing: 0.5 Nm.

The LED modules are mounted with min. 4 screws and the LEDiL DAISY-MINI. If no LEDiL DAISY-MINI is mounted, use plastic washers.



Chemical substance may harm the LED module. Chemical reactions could lead to colour shift, reduced luminous flux or a total failure of the module caused by corrosion of electrical connections.

Materials which are used in LED applications (e.g. sealings, adhesives) must not produce dissolver gas. They must not be condensation curing based, acetate curing based or contain sulfur, chlorine or phthalate.

Avoid corrosive atmosphere during usage and storage.

3.5 EOS/ESD safety guidelines



The device / module contains components that are sensitive to electrostatic discharge and may only be installed in the factory and on site if appropriate EOS/ESD protection measures have been taken. No special measures need be taken for devices/modules with enclosed casings (contact with the pc board not possible), just normal installation practice. Please note the requirements set out in the document EOS / ESD guidelines (Guideline_EOS_ESD.pdf) at: <http://www.tridonic.com/esd-protection>

4. Lifetime

4.1 Lifetime, lumen maintenance and failure rate

The light output of an LED module decreases over the lifetime, this is characterized with the L value.

L70 means that the LED module will give 70 % of its initial luminous flux.

This value is always related to the number of operation hours and therefore defines the lifetime of an LED module.

As the L value is a statistical value and the lumen maintenance may vary over the delivered LED modules.

The B value defines the amount of modules which are below the specific L value, e.g. L70B10 means 10 % of the LED modules are below 70 % of the initial luminous flux, respectively 90 % will be above 70 % of the initial value.

In addition the percentage of failed modules (fatal failure) is characterized by the C value.

4.2 Lumen maintenance for LLE 20mm DL PRE

LLE 20x280mm 750lm 927-965 DL PRE

Forward current	tp tempera- ture	L90 / B10	L90 / B50	L80 / B10	L80 / B50	L70 / B10	L70 / B50
		100 mA	55 °C	52k h	52k h	> 102k h	> 102k h
	80 °C	52k h	52k h	> 102k h	> 102k h	> 102k h	> 102k h
350 mA	55 °C	52k h	52k h	> 102k h	> 102k h	> 102k h	> 102k h
	80 °C	52k h	52k h	> 102k h	> 102k h	> 102k h	> 102k h

L00C03 >102k h. At tp rated and I rated, based on 10 switching cycles per day.

4.3 Switching capability

100,000 cycles

Tridonic test according to IEC 62717 Cl 10.3.3

30 s on / 30 s off at I_{max}

5. Electrical values

5.1 Declaration of electrical parameters

Irated ... Nominal operating current the module is designed for.

I_{max} ... Max. permissible continuous operating current incl. The tolerances of the LED driver.

Max. permissible LF current ripple ... Max. output current of the LED driver incl. Tolerances and LF current ripple must not exceed this value.

Max. permissible peak current ... The max. output peak current of the LED driver must not exceed this value.

5.2 Typ. forward voltage vs. forward current

LLE 20x280mm 750lm 9xx DL PRE

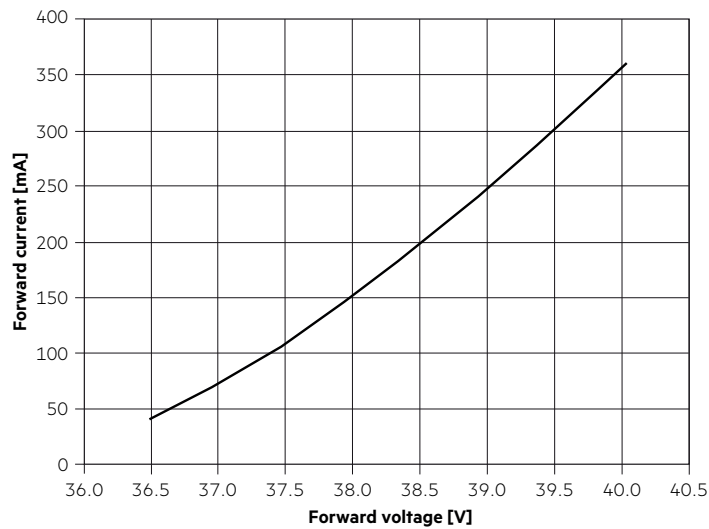

5.3 Forward voltage vs. tc temperature

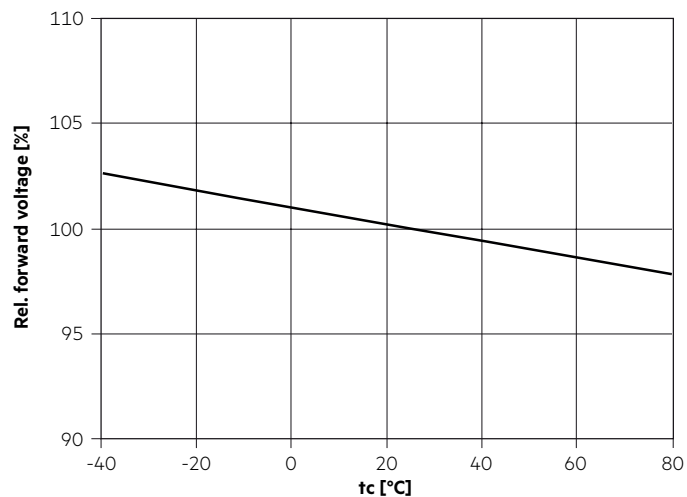

The diagrams are based on statistic values.
The real values can be different.

6. Photometric characteristics

6.1 Coordinates and tolerances according to CIE 1931

The specified colour coordinates are measured integral after a settling time of 100 ms. The current impuls depends on the module type.
 The ambient temperature of the measurement is $t_a = 25^\circ\text{C}$.
 The measurement tolerance of the colour coordinates are ± 0.01 .

Module type	Current impulse
LLE 20x280mm 750lm xxx DL PRE	55 mA

2,700 K

	x0	y0
Centre	0.4578	0.4101

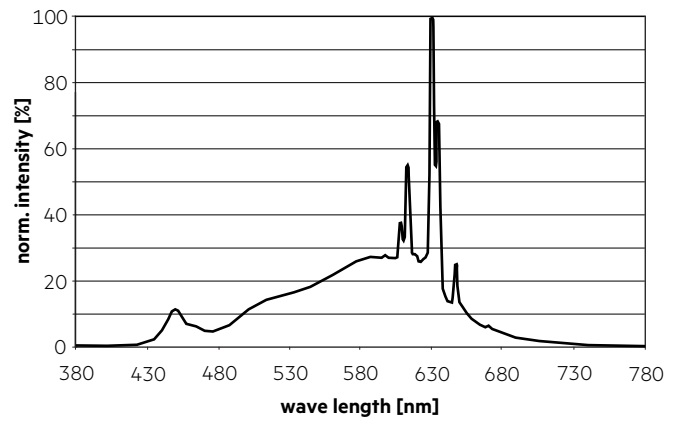
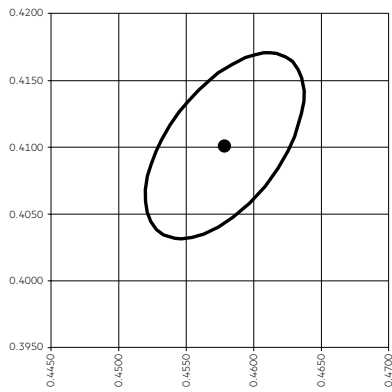

6,500 K

	x0	y0
Centre	0.3123	0.3282

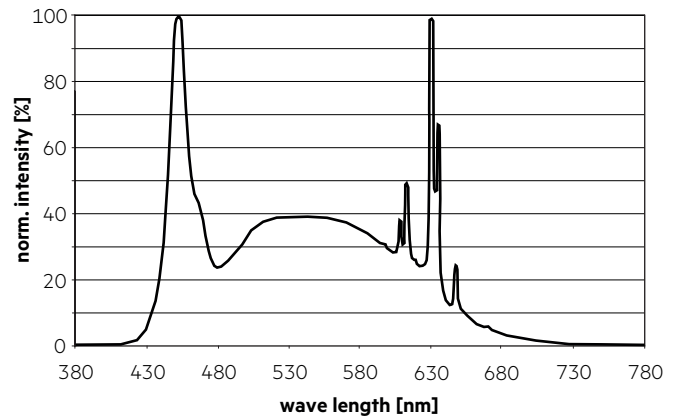
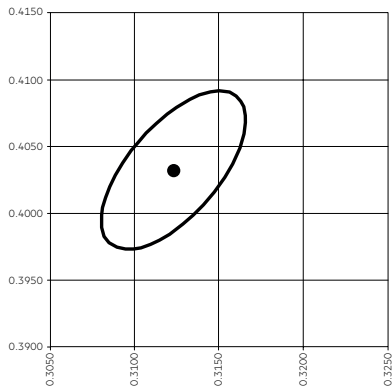

6.2 Light distribution

The optical design of the LLE product line ensures optimum homogeneity for the light distribution.

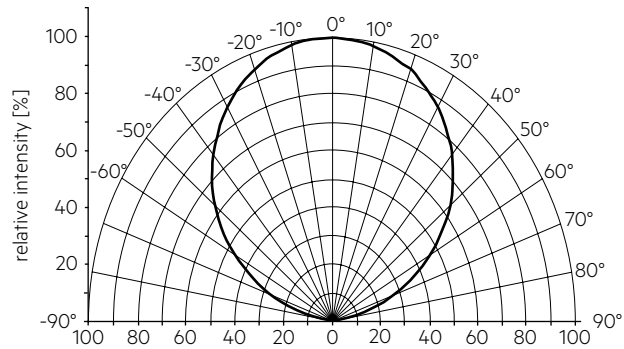

The colour temperature is measured integral over the complete module. The single LED light points can have deviations in the colour coordinates within MacAdam 5. To ensure an ideal mixture of colours and a homogeneous light distribution a suitable optic (e. g. PMMA diffuser) and a sufficient spacing between module and optic (typ. 4 cm) should be used.

7. Miscellaneous

7.1 Additional information

Additional technical information at www.tridonic.com → Technical Data

Lifetime declarations are informative and represent no warranty claim.

6.3 Relative luminous flux vs. tc temperature

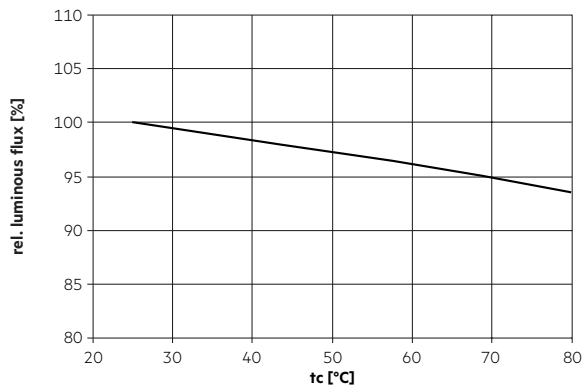

6.4 Relative luminous flux vs. operating current

LLE 20x280mm DL PRE

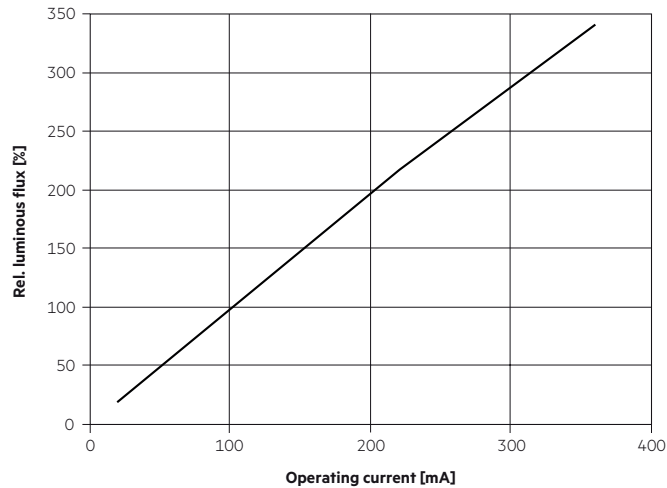

The diagrams are based on statistic values. The real values can be different.