

**Module LLE 16mm 1250lm CRI90 HV ADV6**

Modules LLE advanced



LLE 16x70mm 325lm HV ADV6



LLE 16x140mm 650lm HV ADV6



LLE 16x280mm 1250lm HV ADV6

**Product description**

- \_ Ideal for compact linear luminaire designs
- \_ Homogenous illumination thanks to small package distance
- \_ 2 terminals for serial wiring
- \_ Perfectly uniform light, even if several LED modules are used together in a line
- \_ Push terminals for quick and simple wiring of LED module to LED module
- \_ Min. order quantity LLE 16x70mm QTY4: 36 pcs. The LLE 16x70mm QTY4 module contains 4 single 16x70mm modules which have to be separated.
- \_ HE ... High Efficiency, NM ... Nominal Mode, HO ... High Output
- \_ Long lifetime up to 102,000 hours
- \_ 5 years guarantee (conditions at <https://www.tridonic.com/en/int/services/manufacturer-guarantee-conditions>)

**Optical properties**

- \_ Colour temperatures 2,700, 3,000, 3,500 and 4,000 K
- \_ Efficacy of the LED module 173 lm/W at Irated and tp = 25 °C
- \_ High colour rendering index CRI > 90
- \_ High colour consistency (MacAdam 3) ①
- \_ Small luminous flux tolerances

**Mechanical properties**

- \_ Module dimension 16 x 70 mm, 16 x 140 mm, 16 x 280 mm and 16 x 560 mm
- \_ Simple installation via clips or screws

**System solution**

- \_ Integrate compatible partner products into your final system solution: <https://www.tridonic.com/en/int/products/accessories#partner>
- \_ Combine Tridonic's LED modules and dimmable drivers to achieve an outstanding system efficacy (configuration possible via <https://setbuilder.tridonic.com/>)

① Integral measurement over the complete module.

**Website**

<http://www.tridonic.com/28004982>

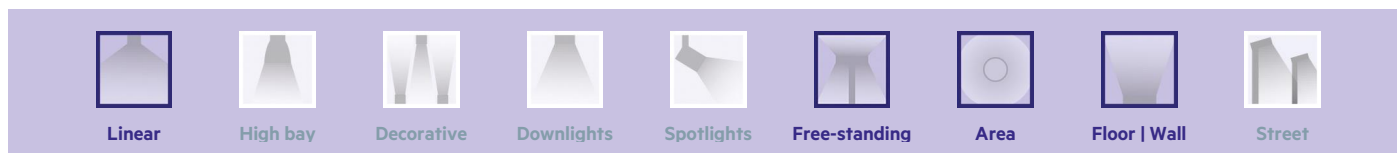
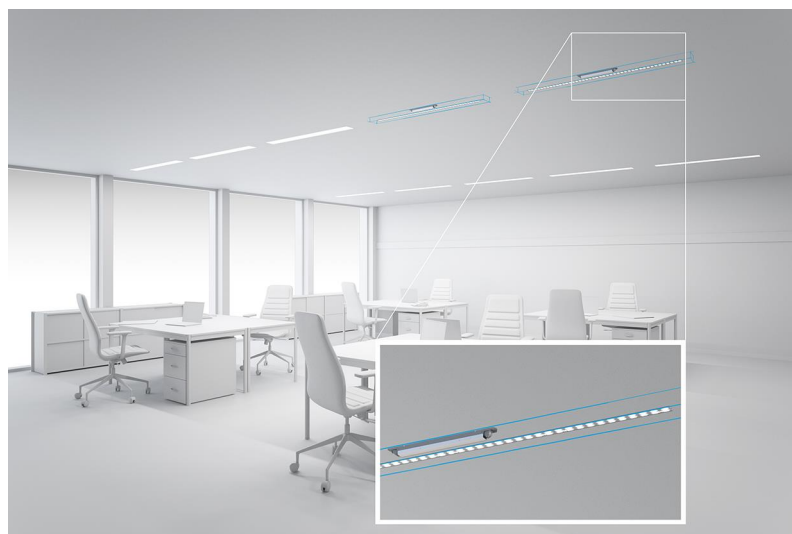

**Module LLE 16mm 1250lm CRI90 HV ADV6**  
Modules LLE advanced

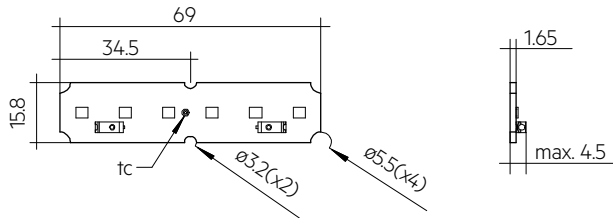

LLE 16x70mm 325lm HV ADV6

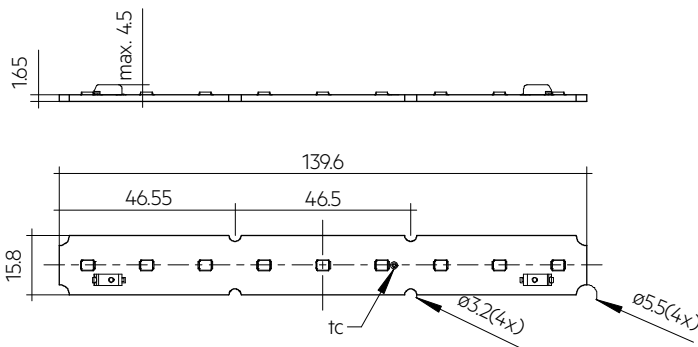

LLE 16x140mm 650lm HV ADV6

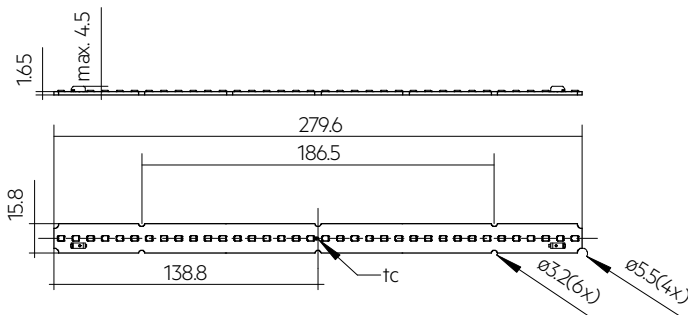

LLE 16x280mm 1250lm HV ADV6

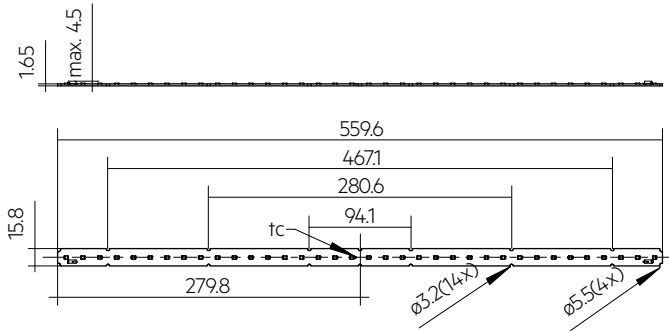

LLE 16x560mm 2400lm HV ADV6

**Ordering data**

| Type                               | Article number | Colour temperature | Packaging, carton | Weight per pc. |
|------------------------------------|----------------|--------------------|-------------------|----------------|
| LLE 16x70mm 325lm 930 HV ADV6 QTY4 | 28004982       | 3,000 K            | 144 pc(s).        | 0.017 kg       |
| LLE 16x70mm 325lm 940 HV ADV6 QTY4 | 28004983       | 4,000 K            | 144 pc(s).        | 0.017 kg       |
| LLE 16x140mm 650lm 927 HV ADV6     | 28004994       | 2,700 K            | 144 pc(s).        | 0.007 kg       |
| LLE 16x140mm 650lm 930 HV ADV6     | 28004995       | 3,000 K            | 144 pc(s).        | 0.007 kg       |
| LLE 16x140mm 650lm 935 HV ADV6     | 28004996       | 3,500 K            | 144 pc(s).        | 0.007 kg       |
| LLE 16x140mm 650lm 940 HV ADV6     | 28004997       | 4,000 K            | 144 pc(s).        | 0.007 kg       |
| LLE 16x280mm 1250lm 927 HV ADV6    | 28005006       | 2,700 K            | 144 pc(s).        | 0.014 kg       |
| LLE 16x280mm 1250lm 930 HV ADV6    | 28005007       | 3,000 K            | 144 pc(s).        | 0.014 kg       |
| LLE 16x280mm 1250lm 935 HV ADV6    | 28005008       | 3,500 K            | 144 pc(s).        | 0.014 kg       |
| LLE 16x280mm 1250lm 940 HV ADV6    | 28005009       | 4,000 K            | 144 pc(s).        | 0.014 kg       |
| LLE 16x560mm 2400lm 927 HV ADV6    | 28005016       | 2,700 K            | 144 pc(s).        | 0.028 kg       |
| LLE 16x560mm 2400lm 930 HV ADV6    | 28005017       | 3,000 K            | 144 pc(s).        | 0.028 kg       |
| LLE 16x560mm 2400lm 935 HV ADV6    | 28005018       | 3,500 K            | 144 pc(s).        | 0.028 kg       |
| LLE 16x560mm 2400lm 940 HV ADV6    | 28005019       | 4,000 K            | 144 pc(s).        | 0.028 kg       |

**Technical data**

|   |  |
|---|--|
| Beam characteristic   | 360°   |
| Ambient temperature $t_a$   | -40 ... +65 °C   |
| $t_p$ rated   | 50 °C  |
| $t_c$   | 85 °C  |
| $I_{rated}$   | 275 mA   |
| $I_{max}$   | 700 mA   |
| Max. permissible LF current ripple  | 800 mA   |
| Max. permissible peak current   | 1,350 mA / max. 10 ms                                    |
| Max. working voltage for insulation <sup>®</sup>                                  | 440 V  |
| Insulation test voltage   | 1.88 kV  |
| Colour tolerance  | 3 SDCM   |
| ESD classification  | Severity level 2   |
| Risk group (IEC 62471)  | RG1 (> 280 – 700 mA ( $I_{max}$ )), RGO ( $\leq$ 280 mA) |
| Classification acc. to IEC 62031  | Built-in   |
| Type of protection  | IP00   |
| Lumen maintenance L70B50  | 102,000 h  |
| Guarantee (conditions at <a href="http://www.tridonic.com">www.tridonic.com</a> ) | 5 Year(s)  |

**Approval marks****Standards**

IEC 62031, IEC 62471, IEC 61000-4-2, IEC 62778, IEC 61547

## Specific technical data

| Type                               | Article number | Photometric code | Useful luminous flux at $t_p = 25^\circ\text{C}$ <sup>②</sup> | Expected luminous flux at $t_p$ rated <sup>③</sup> | Typ. forward current | Min. forward voltage at $t_p$ rated | Max. forward voltage at $t_p = 25^\circ\text{C}$ | Power consumption $P_{on}$ at $t_p = 25^\circ\text{C}$ <sup>④</sup> | Efficacy of the module at $t_p = 25^\circ\text{C}$ | Expected efficacy of the module at $t_p$ rated | Colour rendering index CRI |
|------------------------------------|----------------|------------------|---|--|----------------------|-------------------------------------|--|---|--|--|----------------------------|
| <b>Operating mode HE</b>           |                |                  |   |  |                      |                                     |  |   |  |  |                            |
| LLE 16x70mm 325lm 930 HV ADV6 QTY4 | 28004982       | 930/359          | -   | 89 lm  | 100 mA               | 5.0 V                               | 5.5 V  | -   | -  | 169 lm/W                                       | >90                        |
| LLE 16x70mm 325lm 940 HV ADV6 QTY4 | 28004983       | 940/359          | -   | 93 lm  | 100 mA               | 5.0 V                               | 5.5 V  | -   | -  | 175 lm/W                                       | >90                        |
| LLE 16x140mm 650lm 927 HV ADV6     | 28004994       | 927/359          | -   | 173 lm   | 100 mA               | 10.1 V                              | 11.0 V   | -   | -  | 164 lm/W                                       | >90                        |
| LLE 16x140mm 650lm 930 HV ADV6     | 28004995       | 930/359          | -   | 178 lm   | 100 mA               | 10.1 V                              | 11.0 V   | -   | -  | 169 lm/W                                       | >90                        |
| LLE 16x140mm 650lm 935 HV ADV6     | 28004996       | 935/359          | -   | 183 lm   | 100 mA               | 10.1 V                              | 11.0 V   | -   | -  | 173 lm/W                                       | >90                        |
| LLE 16x140mm 650lm 940 HV ADV6     | 28004997       | 940/359          | -   | 185 lm   | 100 mA               | 10.1 V                              | 11.0 V   | -   | -  | 175 lm/W                                       | >90                        |
| LLE 16x280mm 1250lm 927 HV ADV6    | 28005006       | 927/359          | -   | 346 lm   | 100 mA               | 20.2 V                              | 22.0 V   | -   | -  | 164 lm/W                                       | >90                        |
| LLE 16x280mm 1250lm 930 HV ADV6    | 28005007       | 930/359          | -   | 356 lm   | 100 mA               | 20.2 V                              | 22.0 V   | -   | -  | 169 lm/W                                       | >90                        |
| LLE 16x280mm 1250lm 935 HV ADV6    | 28005008       | 935/359          | -   | 366 lm   | 100 mA               | 20.2 V                              | 22.0 V   | -   | -  | 173 lm/W                                       | >90                        |
| LLE 16x280mm 1250lm 940 HV ADV6    | 28005009       | 940/359          | -   | 370 lm   | 100 mA               | 20.2 V                              | 22.0 V   | -   | -  | 175 lm/W                                       | >90                        |
| LLE 16x560mm 2400lm 927 HV ADV6    | 28005016       | 927/359          | -   | 691 lm   | 100 mA               | 40.3 V                              | 43.9 V   | -   | -  | 164 lm/W                                       | >90                        |
| LLE 16x560mm 2400lm 930 HV ADV6    | 28005017       | 930/359          | -   | 712 lm   | 100 mA               | 40.3 V                              | 43.9 V   | -   | -  | 169 lm/W                                       | >90                        |
| LLE 16x560mm 2400lm 935 HV ADV6    | 28005018       | 935/359          | -   | 731 lm   | 100 mA               | 40.3 V                              | 43.9 V   | -   | -  | 173 lm/W                                       | >90                        |
| LLE 16x560mm 2400lm 940 HV ADV6    | 28005019       | 940/359          | -   | 741 lm   | 100 mA               | 40.3 V                              | 43.9 V   | -   | -  | 175 lm/W                                       | >90                        |
| <b>Operating mode NM</b>           |                |                  |   |  |                      |                                     |  |   |  |  |                            |
| LLE 16x70mm 325lm 930 HV ADV6 QTY4 | 28004982       | 930/359          | 250 lm  | 240 lm   | 275 mA               | 5.2 V                               | 5.7 V  | 1.5 W   | 165 lm/W   | 160 lm/W                                       | >90                        |
| LLE 16x70mm 325lm 940 HV ADV6 QTY4 | 28004983       | 940/359          | 260 lm  | 250 lm   | 275 mA               | 5.2 V                               | 5.7 V  | 1.5 W   | 172 lm/W   | 166 lm/W                                       | >90                        |
| LLE 16x140mm 650lm 927 HV ADV6     | 28004994       | 927/359          | 486 lm  | 466 lm   | 275 mA               | 10.4 V                              | 11.4 V   | 3.0 W   | 160 lm/W   | 155 lm/W                                       | >90                        |
| LLE 16x140mm 650lm 930 HV ADV6     | 28004995       | 930/359          | 501 lm  | 480 lm   | 275 mA               | 10.4 V                              | 11.4 V   | 3.0 W   | 165 lm/W   | 160 lm/W                                       | >90                        |
| LLE 16x140mm 650lm 935 HV ADV6     | 28004996       | 935/359          | 514 lm  | 493 lm   | 275 mA               | 10.4 V                              | 11.4 V   | 3.0 W   | 169 lm/W   | 164 lm/W                                       | >90                        |
| LLE 16x140mm 650lm 940 HV ADV6     | 28004997       | 940/359          | 520 lm  | 499 lm   | 275 mA               | 10.4 V                              | 11.4 V   | 3.0 W   | 172 lm/W   | 166 lm/W                                       | >90                        |
| LLE 16x280mm 1250lm 927 HV ADV6    | 28005006       | 927/359          | 971 lm  | 932 lm   | 275 mA               | 20.9 V                              | 22.7 V   | 6.1 W   | 160 lm/W   | 155 lm/W                                       | >90                        |
| LLE 16x280mm 1250lm 930 HV ADV6    | 28005007       | 930/359          | 1,001 lm  | 961 lm   | 275 mA               | 20.9 V                              | 22.7 V   | 6.1 W   | 165 lm/W   | 160 lm/W                                       | >90                        |
| LLE 16x280mm 1250lm 935 HV ADV6    | 28005008       | 935/359          | 1,028 lm  | 986 lm   | 275 mA               | 20.9 V                              | 22.7 V   | 6.1 W   | 169 lm/W   | 164 lm/W                                       | >90                        |
| LLE 16x280mm 1250lm 940 HV ADV6    | 28005009       | 940/359          | 1,041 lm  | 999 lm   | 275 mA               | 20.9 V                              | 22.7 V   | 6.1 W   | 172 lm/W   | 166 lm/W                                       | >90                        |
| LLE 16x560mm 2400lm 927 HV ADV6    | 28005016       | 927/359          | 1,942 lm  | 1,864 lm   | 275 mA               | 41.8 V                              | 45.4 V   | 12.1 W  | 160 lm/W   | 155 lm/W                                       | >90                        |
| LLE 16x560mm 2400lm 930 HV ADV6    | 28005017       | 930/359          | 2,002 lm  | 1,921 lm   | 275 mA               | 41.8 V                              | 45.4 V   | 12.1 W  | 165 lm/W   | 160 lm/W                                       | >90                        |
| LLE 16x560mm 2400lm 935 HV ADV6    | 28005018       | 935/359          | 2,055 lm  | 1,972 lm   | 275 mA               | 41.8 V                              | 45.4 V   | 12.1 W  | 169 lm/W   | 164 lm/W                                       | >90                        |
| LLE 16x560mm 2400lm 940 HV ADV6    | 28005019       | 940/359          | 2,082 lm  | 1,998 lm   | 275 mA               | 41.8 V                              | 45.4 V   | 12.1 W  | 172 lm/W   | 166 lm/W                                       | >90                        |
| <b>Operating mode HO</b>           |                |                  |   |  |                      |                                     |  |   |  |  |                            |
| LLE 16x70mm 325lm 930 HV ADV6 QTY4 | 28004982       | 930/359          | -   | 499 lm   | 600 mA               | 5.5 V                               | 5.9 V  | -   | -  | 145 lm/W                                       | >90                        |
| LLE 16x70mm 325lm 940 HV ADV6 QTY4 | 28004983       | 940/359          | -   | 519 lm   | 600 mA               | 5.5 V                               | 5.9 V  | -   | -  | 151 lm/W                                       | >90                        |
| LLE 16x140mm 650lm 927 HV ADV6     | 28004994       | 927/359          | -   | 968 lm   | 600 mA               | 11.0 V                              | 11.9 V   | -   | -  | 141 lm/W                                       | >90                        |
| LLE 16x140mm 650lm 930 HV ADV6     | 28004995       | 930/359          | -   | 998 lm   | 600 mA               | 11.0 V                              | 11.9 V   | -   | -  | 145 lm/W                                       | >90                        |
| LLE 16x140mm 650lm 935 HV ADV6     | 28004996       | 935/359          | -   | 1,024 lm   | 600 mA               | 11.0 V                              | 11.9 V   | -   | -  | 149 lm/W                                       | >90                        |
| LLE 16x140mm 650lm 940 HV ADV6     | 28004997       | 940/359          | -   | 1,038 lm   | 600 mA               | 11.0 V                              | 11.9 V   | -   | -  | 151 lm/W                                       | >90                        |
| LLE 16x280mm 1250lm 927 HV ADV6    | 28005006       | 927/359          | -   | 1,936 lm   | 600 mA               | 21.9 V                              | 23.8 V   | -   | -  | 141 lm/W                                       | >90                        |
| LLE 16x280mm 1250lm 930 HV ADV6    | 28005007       | 930/359          | -   | 1,996 lm   | 600 mA               | 21.9 V                              | 23.8 V   | -   | -  | 145 lm/W                                       | >90                        |
| LLE 16x280mm 1250lm 935 HV ADV6    | 28005008       | 935/359          | -   | 2,049 lm   | 600 mA               | 21.9 V                              | 23.8 V   | -   | -  | 149 lm/W                                       | >90                        |
| LLE 16x280mm 1250lm 940 HV ADV6    | 28005009       | 940/359          | -   | 2,075 lm   | 600 mA               | 21.9 V                              | 23.8 V   | -   | -  | 151 lm/W                                       | >90                        |
| LLE 16x560mm 2400lm 927 HV ADV6    | 28005016       | 927/359          | -   | 3,873 lm   | 600 mA               | 43.9 V                              | 47.5 V   | -   | -  | 141 lm/W                                       | >90                        |
| LLE 16x560mm 2400lm 930 HV ADV6    | 28005017       | 930/359          | -   | 3,991 lm   | 600 mA               | 43.9 V                              | 47.5 V   | -   | -  | 145 lm/W                                       | >90                        |
| LLE 16x560mm 2400lm 935 HV ADV6    | 28005018       | 935/359          | -   | 4,097 lm   | 600 mA               | 43.9 V                              | 47.5 V   | -   | -  | 149 lm/W                                       | >90                        |
| LLE 16x560mm 2400lm 940 HV ADV6    | 28005019       | 940/359          | -   | 4,150 lm   | 600 mA               | 43.9 V                              | 47.5 V   | -   | -  | 151 lm/W                                       | >90                        |

② If mounted with M3 screws with 6 mm head diameter and plastic washer.

③ The detailed explanation, see data sheet section 1.1.

④ Tolerance of useful light flux - 0 % / + 15 %. Measurement uncertainty  $\pm 10$  %.

⑤ Measurement uncertainty  $\pm 10$  %. Based on calculation.

⑥ Tolerance of power consumption  $P_{on} \pm 10$  %. Measurement uncertainty  $\pm 5$  %.

## ACL BRIDGE LLE16

Accessory

**Product description**

- \_ Clip for fixation for LLE16
- \_ Fast snap on mounting (for sheet thickness 0.5 – 1.0 mm)
- \_ For drilling hole 3 mm
- \_ Clip made of polycarbonate
- \_ Minimum sales quantity 200 pcs.

**Website**

<http://www.tridonic.com/28001035>

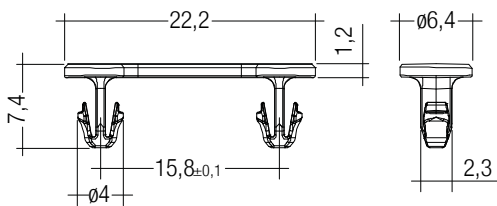
**Ordering data**

| Type                      | Article number | Colour | Packaging, bag | Weight per pc. |
|---------------------------|----------------|--------|----------------|----------------|
| ACL BRIDGE LLE16 PUSH-FIX | 28001035       | White  | 200 pc(s).     | 0.001 kg       |

## ACL LINEAR COVER 16mm

Accessory

**Product description**

- \_ LINEAR COVER for LLE 16
- \_ Protection against direct touch for non-SELV applications (recommendation: use all fixing points) <sup>①</sup>
- \_ Fast snap on mounting on to LLE 16 with clips or plastic washers
- \_ High transmission: transparent, semi-transparent and diffuse
- \_ Linear lense made of PMMA
- \_ Tolerances LINEAR COVER: + 10 mm for 1,600 / 1,200 mm length (ends raw)

① Ends must be covered by the luminaire construction.

**Website**

<http://www.tridonic.com/28000950>

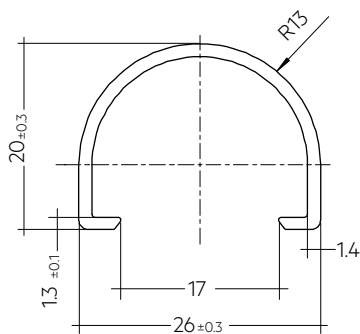
**Ordering data**

| Type                               | Article number | Colour           | Length L | Packaging, carton | Weight per pc. |
|------------------------------------|----------------|------------------|----------|-------------------|----------------|
| ACL LINEAR COVER 16x1600mm FROSTED | 28000950       | Semi-transparent | 1,600 mm | 24 pc(s).         | 0.147 kg       |
| ACL LINEAR COVER 16x1200mm FROSTED | 28002827       | Semi-transparent | 1,200 mm | 24 pc(s).         | 0.100 kg       |
| ACL LINEAR COVER 16x1600mm DIFFUSE | 28000951       | Diffuse          | 1,600 mm | 24 pc(s).         | 0.147 kg       |
| ACL LINEAR COVER 16x1200mm DIFFUSE | 28002828       | Diffuse          | 1,200 mm | 24 pc(s).         | 0.100 kg       |

## 1. Standards

IEC 62031  
IEC 62471  
IEC 61000-4-2  
IEC 62778  
IEC 61547

### 1.1 Photometric code

Key for photometric code, e. g. 830 / 349

| 1 <sup>st</sup> digit | 2 <sup>nd</sup> + 3 <sup>rd</sup> digit | 4 <sup>th</sup> digit | 5 <sup>th</sup> digit                         | 6 <sup>th</sup> digit                               |               |        |
|-----------------------|---|-----------------------|---|---|---------------|--------|
| Code                  | Colour temperature in Kelvin x 100      | MacAdam initial       | MacAdam after 25% of the lifetime (max.6000h) | Luminous flux after 25% of the lifetime (max.6000h) |               |        |
|                       |   |                       |   | Code  | Luminous flux |        |
| 7                     |   |                       |   | 70 – 79   | 7             | ≥ 70 % |
| 8                     |   |                       |   | 80 – 89   | 8             | ≥ 80 % |
| 9                     | ≥90                                     | 9                     | ≥ 90 %  |   |               |        |

### 1.2 Risk group

| Forward current       | Risk group (IEC 62471) |
|-----------------------|------------------------|
| ≤ 280 mA              | RG0                    |
| > 280 – 700 mA (Imax) | RG1                    |

### 1.3 Energy classification

| Type                               | Colour temperature | Forward current | Energy classification | Energy consumption |
|------------------------------------|--------------------|-----------------|-----------------------|--------------------|
| LLE 16x70mm 325lm 930 HV ADV6 QTY4 | 3,000 K            | 275 mA          | D                     | 2 kWh / 1,000 h    |
| LLE 16x70mm 325lm 940 HV ADV6 QTY4 | 4,000 K            | 275 mA          | C                     | 2 kWh / 1,000 h    |
| LLE 16x140mm 650lm 927 HV ADV6     | 2,700 K            | 275 mA          | D                     | 4 kWh / 1,000 h    |
| LLE 16x140mm 650lm 930 HV ADV6     | 3,000 K            | 275 mA          | D                     | 4 kWh / 1,000 h    |
| LLE 16x140mm 650lm 935 HV ADV6     | 3,500 K            | 275 mA          | D                     | 4 kWh / 1,000 h    |
| LLE 16x140mm 650lm 940 HV ADV6     | 4,000 K            | 275 mA          | C                     | 4 kWh / 1,000 h    |
| LLE 16x280mm 1250lm 927 HV ADV6    | 2,700 K            | 275 mA          | D                     | 7 kWh / 1,000 h    |
| LLE 16x280mm 1250lm 930 HV ADV6    | 3,000 K            | 275 mA          | D                     | 7 kWh / 1,000 h    |
| LLE 16x280mm 1250lm 935 HV ADV6    | 3,500 K            | 275 mA          | D                     | 7 kWh / 1,000 h    |
| LLE 16x280mm 1250lm 940 HV ADV6    | 4,000 K            | 275 mA          | D                     | 7 kWh / 1,000 h    |
| LLE 16x560mm 2400lm 927 HV ADV6    | 2,700 K            | 275 mA          | D                     | 13 kWh / 1,000 h   |
| LLE 16x560mm 2400lm 930 HV ADV6    | 3,000 K            | 275 mA          | D                     | 13 kWh / 1,000 h   |
| LLE 16x560mm 2400lm 935 HV ADV6    | 3,500 K            | 275 mA          | C                     | 13 kWh / 1,000 h   |
| LLE 16x560mm 2400lm 940 HV ADV6    | 4,000 K            | 275 mA          | D                     | 13 kWh / 1,000 h   |

Energy label and further information at [www.tridonic.com](http://www.tridonic.com) in the certificates tab of the corresponding product page and at the EPREL data base <https://eprel.ec.europa.eu/>

## 2. Thermal details

### 2.1 tc point, ambient temperature and lifetime

The temperature at tp reference point is crucial for the light output and lifetime of a LED product.

For LLE a tp temperature of 50 °C has to be complied in order to achieve an optimum between heat sink requirements, light output and lifetime.

Compliance with the maximum permissible reference temperature at the tc point must be checked under operating conditions in a thermally stable state. The maximum value must be determined under worst-case conditions for the relevant application.

The tc and tp temperature of LED modules from Tridonic are measured at the same reference point.

### 2.2 Storage and humidity

|                     |                |
|---------------------|----------------|
| Storage temperature | -40 ... +85 °C |
|---------------------|----------------|

Operation only in non condensing environment.

Humidity during processing of the module should be between 30 to 70 %.

### 2.3 Heat sink values

#### LLE 16x70mm 325lm ADV6

| ta    | tp    | Forward current | R <sub>th, hs-a</sub> | Cooling area        |
|-------|-------|-----------------|-----------------------|---------------------|
| 25 °C | 50 °C | 275 mA          | 37.75 K/W             | 18 cm <sup>2</sup>  |
| 25 °C | 50 °C | 600 mA          | 9.59 K/W              | 70 cm <sup>2</sup>  |
| 35 °C | 50 °C | 275 mA          | 20.94 K/W             | 32 cm <sup>2</sup>  |
| 35 °C | 50 °C | 600 mA          | 4.04 K/W              | 165 cm <sup>2</sup> |
| 40 °C | 50 °C | 275 mA          | 12.53 K/W             | 53 cm <sup>2</sup>  |
| 40 °C | 50 °C | 600 mA          | 1.26 K/W              | 528 cm <sup>2</sup> |
| 45 °C | 50 °C | 275 mA          | 4.12 K/W              | 162 cm <sup>2</sup> |

#### LLE 16x140mm 650lm ADV6

| ta    | tp    | Forward current | R <sub>th, hs-a</sub> | Cooling area         |
|-------|-------|-----------------|-----------------------|----------------------|
| 25 °C | 50 °C | 275 mA          | 18.88 K/W             | 35 cm <sup>2</sup>   |
| 25 °C | 50 °C | 600 mA          | 4.79 K/W              | 139 cm <sup>2</sup>  |
| 35 °C | 50 °C | 275 mA          | 10.47 K/W             | 64 cm <sup>2</sup>   |
| 35 °C | 50 °C | 600 mA          | 2.02 K/W              | 330 cm <sup>2</sup>  |
| 40 °C | 50 °C | 275 mA          | 6.26 K/W              | 106 cm <sup>2</sup>  |
| 40 °C | 50 °C | 600 mA          | 0.63 K/W              | 1056 cm <sup>2</sup> |
| 45 °C | 50 °C | 275 mA          | 2.06 K/W              | 324 cm <sup>2</sup>  |

#### LLE 16x280mm 1250lm ADV6

| ta    | tp    | Forward current | R <sub>th, hs-a</sub> | Cooling area          |
|-------|-------|-----------------|-----------------------|-----------------------|
| 25 °C | 50 °C | 275 mA          | 9.44 K/W              | 71 cm <sup>2</sup>    |
| 25 °C | 50 °C | 600 mA          | 2.40 K/W              | 278 cm <sup>2</sup>   |
| 35 °C | 50 °C | 275 mA          | 5.23 K/W              | 127 cm <sup>2</sup>   |
| 35 °C | 50 °C | 600 mA          | 1.01 K/W              | 661 cm <sup>2</sup>   |
| 40 °C | 50 °C | 275 mA          | 3.13 K/W              | 213 cm <sup>2</sup>   |
| 40 °C | 50 °C | 600 mA          | 0.32 K/W              | 2,111 cm <sup>2</sup> |
| 45 °C | 50 °C | 275 mA          | 1.03 K/W              | 647 cm <sup>2</sup>   |

**LLE 16x560mm 2400lm ADV6**

| ta    | tp    | Forward current | R <sub>th, hs-a</sub> | Cooling area          |
|-------|-------|-----------------|-----------------------|-----------------------|
| 25 °C | 50 °C | 275 mA          | 4.72 K/W              | 141 cm <sup>2</sup>   |
| 25 °C | 50 °C | 600 mA          | 1.20 K/W              | 556 cm <sup>2</sup>   |
| 35 °C | 50 °C | 275 mA          | 2.62 K/W              | 255 cm <sup>2</sup>   |
| 35 °C | 50 °C | 600 mA          | 0.50 K/W              | 1,321 cm <sup>2</sup> |
| 40 °C | 50 °C | 275 mA          | 1.57 K/W              | 426 cm <sup>2</sup>   |
| 40 °C | 50 °C | 600 mA          | 0.16 K/W              | 4,223 cm <sup>2</sup> |
| 45 °C | 50 °C | 275 mA          | 0.52 K/W              | 1,294 cm <sup>2</sup> |

**Notes**

The actual cooling surface can differ because of the material, the structural shape, outside influences and the installation situation. Depending on the heat sink a heat conducting paste or heat conducting film might be necessary to keep the specified tp temperature.

For applications with a small distance between LED module and lens or operating currents higher than 500 mA, screw mounting is recommended to ensure a reliable thermal connection between LED module and cooling surface.

**3. Installation / wiring****3.1 Electrical supply/choice of LED driver**

LLE modules from Tridonic are not protected against overvoltages, overcurrents, overloads or short-circuit currents. Safe and reliable operation can only be guaranteed in conjunction with a LED driver which complies with the relevant standards. The use of LED driver from Tridonic in combination with LLE modules guarantees the necessary protection for safe and reliable operation.

If a LED driver other than Tridonic is used, it must provide the following protection:

- Short-circuit protection
- Overload protection
- Overtemperature protection



LLE modules must be supplied by a constant current LED driver. Operation with a constant voltage LED driver will lead to an irreversible damage of the module.

Wrong polarity can damage the LLE.

The LLE module is designed for serial wiring.

LLE can be operated either from SELV LED drivers or from LED drivers with LV output voltage.



LLE are basic insulated up to 440 V (if mounted with M3 screws with head diameter 6 mm in combination with plastic washers) against ground and can be mounted directly on earthed metal parts of the luminaire. If the max. output voltage of the LED driver (also against earth) is above 440 V, an additional insulation between LED module and heat sink is required (for example by insulated thermal pads) or by a suitable luminaire construction.

At voltages > 60 V an additional protection against direct touch (test finger) to the light emitting side of the module has to be guaranteed. This is typically achieved by means of a non removable light distributor over the module.

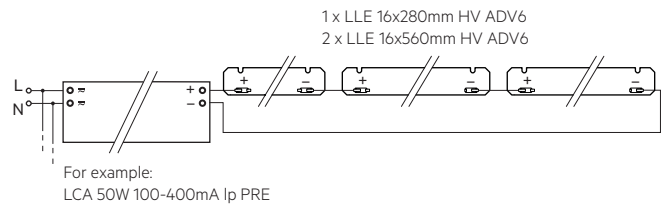
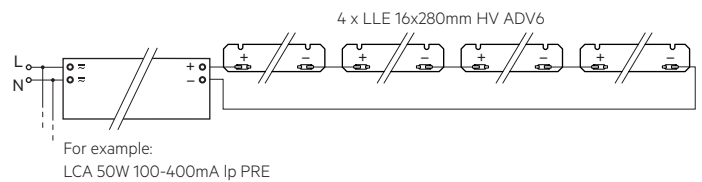
**3.2 Wiring****Wiring examples for serial wiring****3.3 Wiring type and cross section**

For wiring use solid wire from 0.14 to 0.5 mm<sup>2</sup>.

No reconnection with smaller diameters possible if used with >0.34 mm<sup>2</sup>.

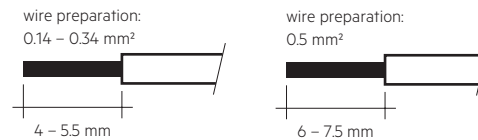

To remove the wires use a suitabel tool (Wago 206-859) or through twist and pull.

### 3.4 Mounting instruction



None of the components of the LLE (substrate, LED, electronic components etc.) may be exposed to tensile or compressive stresses.

Max. torque for fixing: 0.5 Nm.

The LED modules are mounted onto a heat sink with M3 screws with plastic washers or ACL BRIDGE LLE16 PUSH-FIX.

All fastening point must be used for mounting.

The cut-outs on the end faces must not be used for fastening.

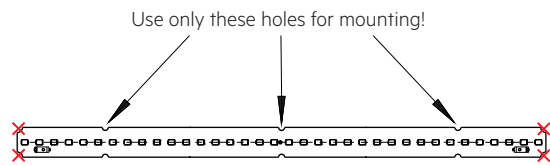

Only touch the module at the edge to separate the modules (see marking below).



Chemical substance may harm the LED module. Chemical reactions could lead to colour shift, reduced luminous flux or a total failure of the module caused by corrosion of electrical connections.

Materials which are used in LED applications (e.g. sealings, adhesives) must not produce dissolver gas. They must not be condensation curing based, acetate curing based or contain sulfur, chlorine or phthalate.

Avoid corrosive atmosphere during usage and storage.

### 3.5 EOS/ESD safety guidelines



The device / module contains components that are sensitive to electrostatic discharge and may only be installed in the factory and on site if appropriate EOS/ESD protection measures have been taken. No special measures need be taken for devices/modules with enclosed casings (contact with the pc board not possible), just normal installation practice. Please note the requirements set out in the document EOS / ESD guidelines (Guideline\_EOS\_ESD.pdf) at: <http://www.tridonic.com/esd-protection>



## 4. Lifetime

### 4.1 Lifetime, lumen maintenance and failure rate

The light output of an LED module decreases over the lifetime, this is characterized with the L value.

L70 means that the LED module will give 70 % of its initial luminous flux.

This value is always related to the number of operation hours and therefore defines the lifetime of an LED module.

As the L value is a statistical value and the lumen maintenance may vary over the delivered LED modules.

The B value defines the amount of modules which are below the specific L value, e.g. L70B10 means 10 % of the LED modules are below 70 % of the initial luminous flux, respectively 90 % will be above 70 % of the initial value.

In addition the percentage of failed modules (fatal failure) is characterized by the C value.

The F value is the combination of the B and C value. That means for F degradation and complete failures are considered, e.g. L70F10 means 10 % of the LED modules may fail or be below 70 % of the initial luminous flux.

### 4.2 Lumen maintenance for LLE 16mm HV ADV6

| Forward current | tp               | L90 / B10 | L90 / B50 | L80 / B10 | L80 / B50 | L70 / B10 | L70 / B50 |
|-----------------|------------------|-----------|-----------|-----------|-----------|-----------|-----------|
|                 | tempera-<br>ture |           |           |           |           |           |           |
| 700 mA          | 55 °C            | 52k h     | 52k h     | > 102k h  | > 102k h  | > 102k h  | > 102k h  |
|                 | 85 °C            | 52k h     | 52k h     | > 102k h  | > 102k h  | > 102k h  | > 102k h  |

L00C03 >102k h. At tp rated and I rated, based on 10 swichting cycles per day.

### 4.3 Switching capability

100,000 cycles

Tridonic test according to IEC 62717 Cl 10.3.3

30 s on / 30 s off at Imax

## 5. Electrical values

### 5.1 Declaration of electrical parameters

Irated ... Nominal operating current the module is designed for.

I<sub>max</sub> ... Max. permissible continuous operating current incl. The tolerances of the LED driver.

Max. permissible LF current ripple ... Max. output current of the LED driver incl. Tolerances and LF current ripple must not exceed this value.

Max. permissible peak current ... The max. output peak current of the LED driver must not exceed this value.

### 5.2 Typ. forward voltage vs. forward current

**LLE 16x70mm 325lm 9xx HV ADV6**

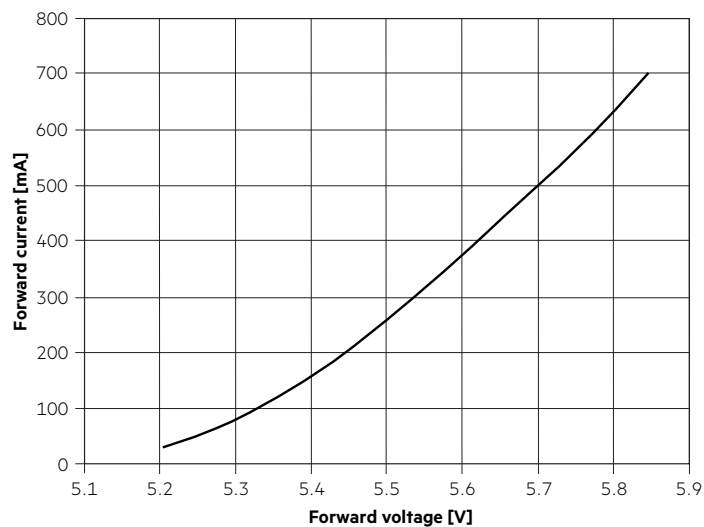

**LLE 16x140mm 650lm 9xx HV ADV6**

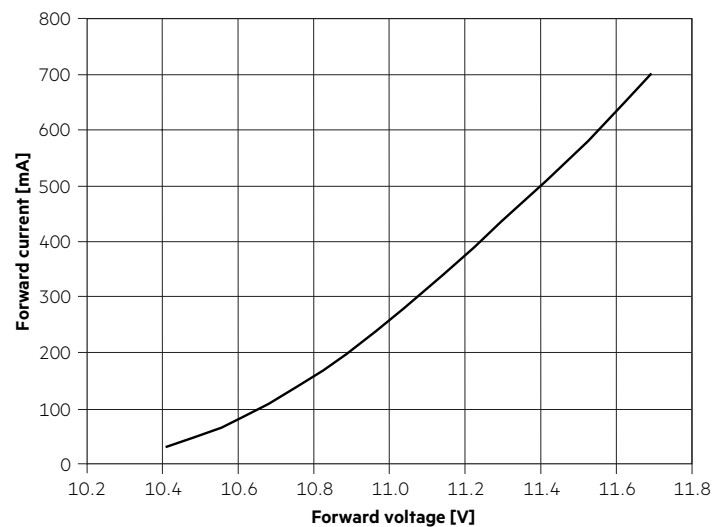

**LLE 16x280mm 1250lm 9xx HV ADV6**

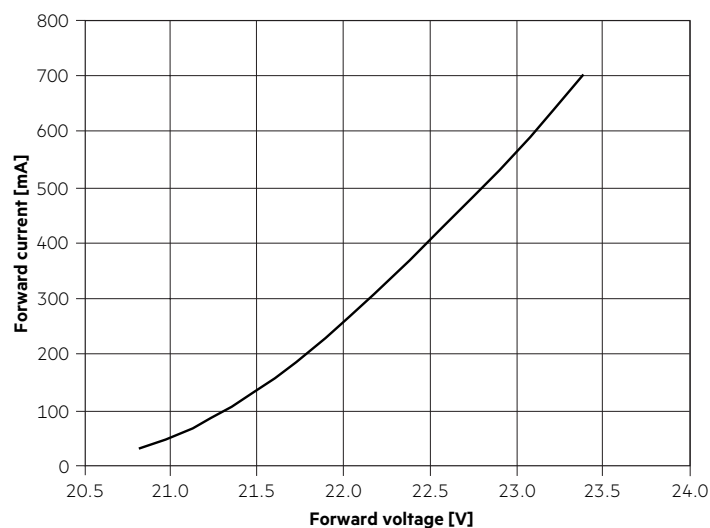

**LLE 16x560mm 2400lm 9xx HV ADV6**

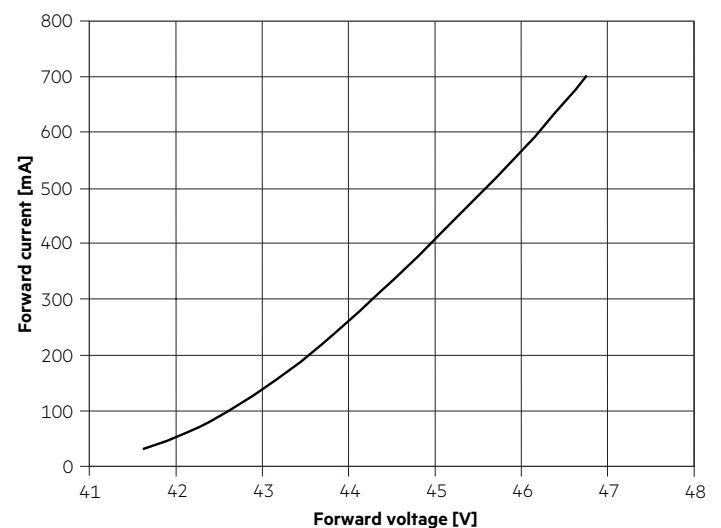

The diagrams are based on statistic values.  
The real values can be different.

5.3 Forward voltage vs. tc temperature

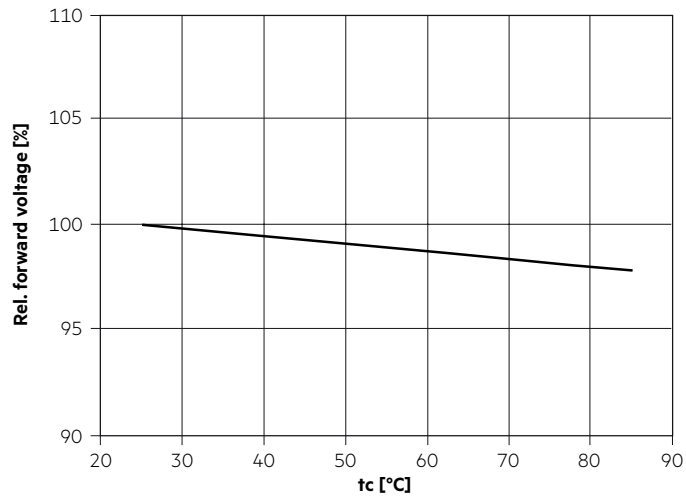

The diagrams are based on statistic values.  
The real values can be different.

## 6. Photometric characteristics

### 6.1 Coordinates and tolerances according to CIE 1931

The specified colour coordinates are integral measured by current impulse of 195 mA and a duration of 100 ms.  
 The ambient temperature of the measurement is  $t_a = 25^\circ\text{C}$ .  
 The measurement tolerance of the colour coordinates are  $\pm 0.01$ .

2,700 K

|        | x0     | y0     |
|--------|--------|--------|
| Centre | 0.4578 | 0.4101 |

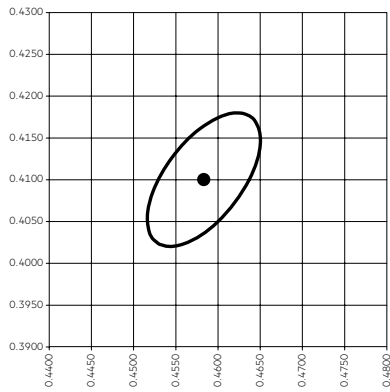

— MacAdam Ellipse: 3SDCM

| TM30 |    | CRI |    |
|------|----|-----|----|
| Rf   | Rg | Ra  | R9 |
| 91   | 99 | 93  | 57 |

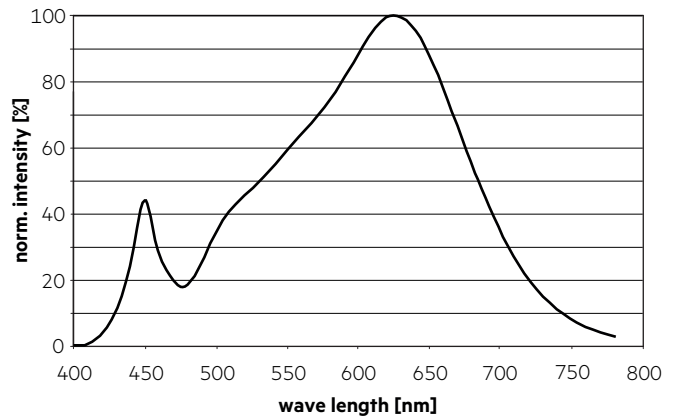

Colour vector graphic

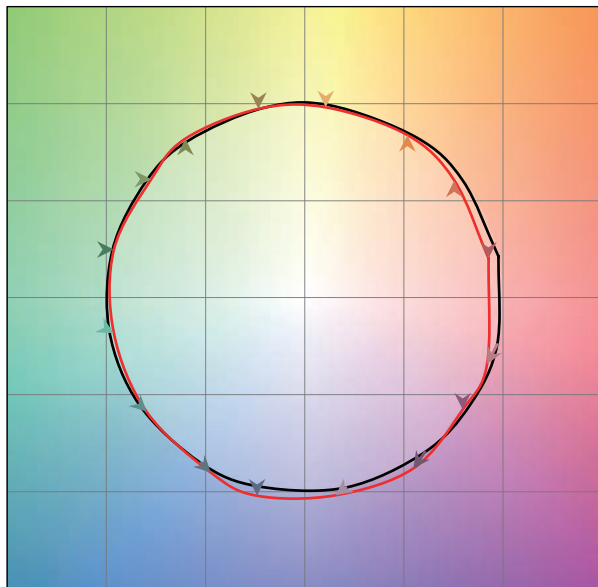

— Reference source  
 — Test source

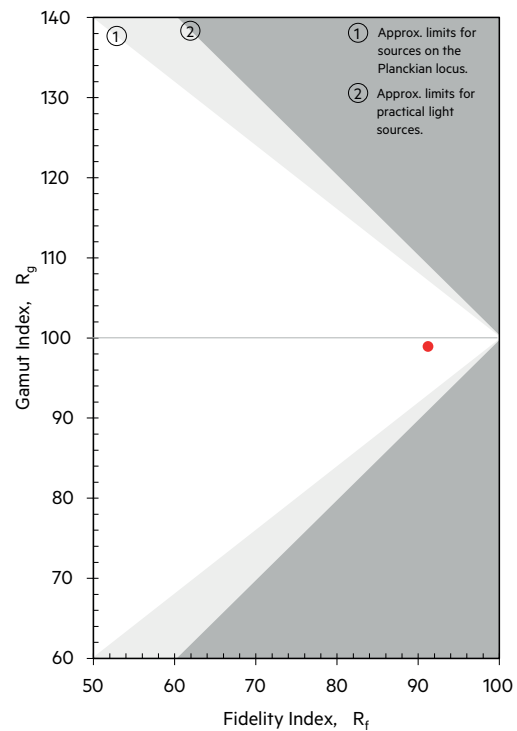

— MacAdam Ellipse: 3SDCM

3,000 K

|        | x0     | y0     |
|--------|--------|--------|
| Centre | 0.4338 | 0.4030 |

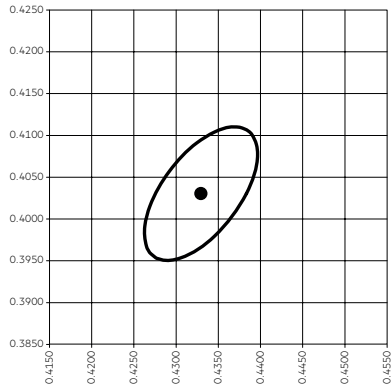

— MacAdam Ellipse: 3SDCM

| TM30 |    | CRI |    |
|------|----|-----|----|
| Rf   | Rg | Ra  | R9 |
| 90   | 98 | 92  | 57 |

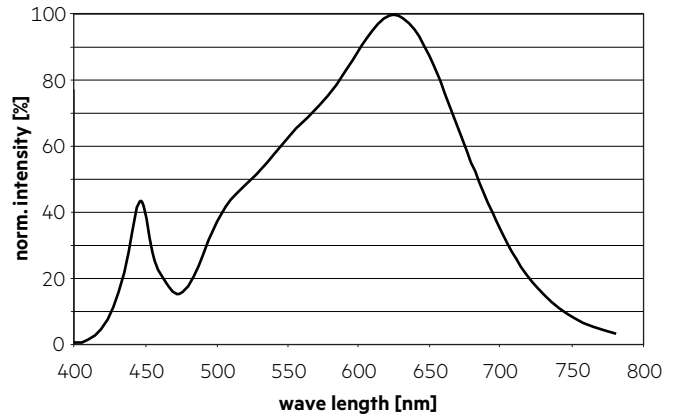

Colour vector graphic

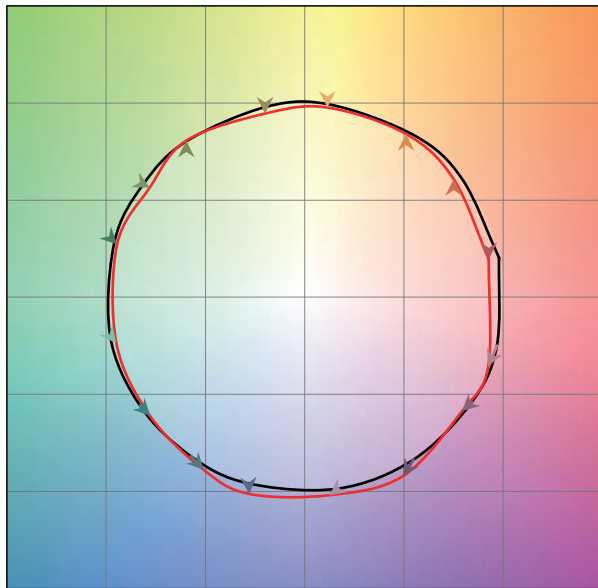

— Reference source  
— Test source

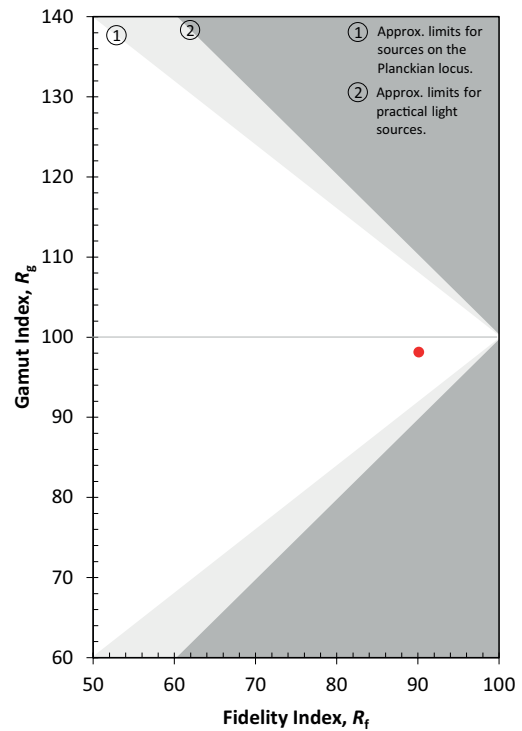

3,500 K

|        | x0     | y0     |
|--------|--------|--------|
| Centre | 0.4073 | 0.3917 |

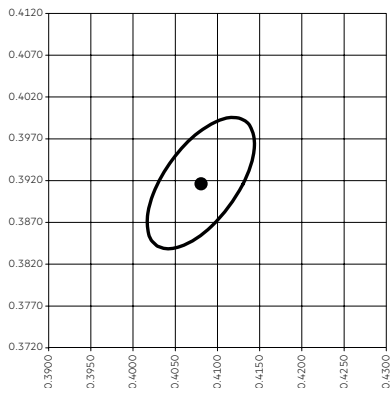

| TM30 |    | CRI |    |
|------|----|-----|----|
| Rf   | Rg | Ra  | R9 |
| 90   | 99 | 93  | 63 |

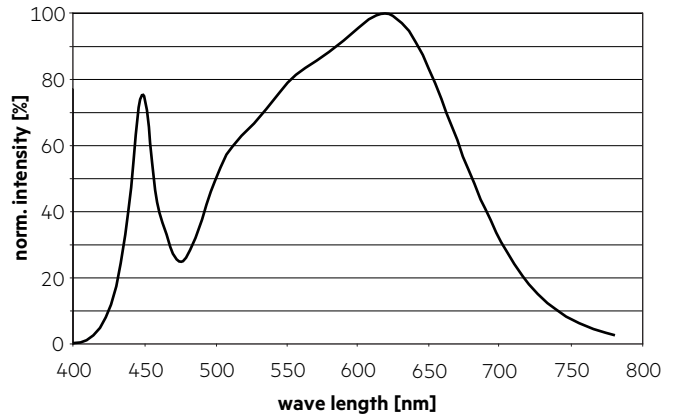

Colour vector graphic

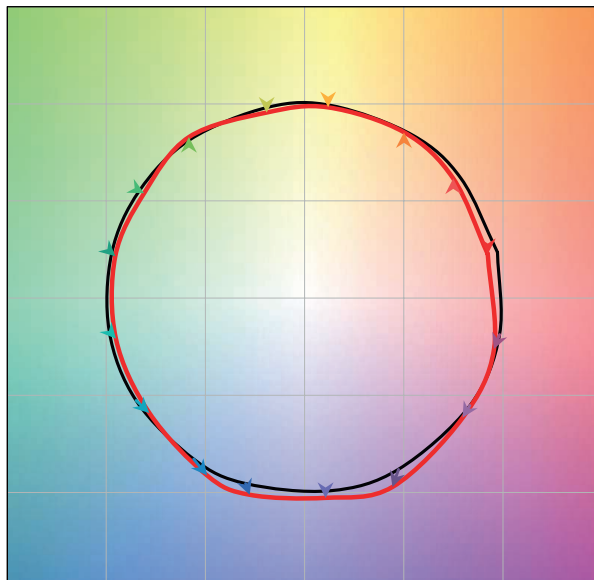

— Reference source  
— Test source

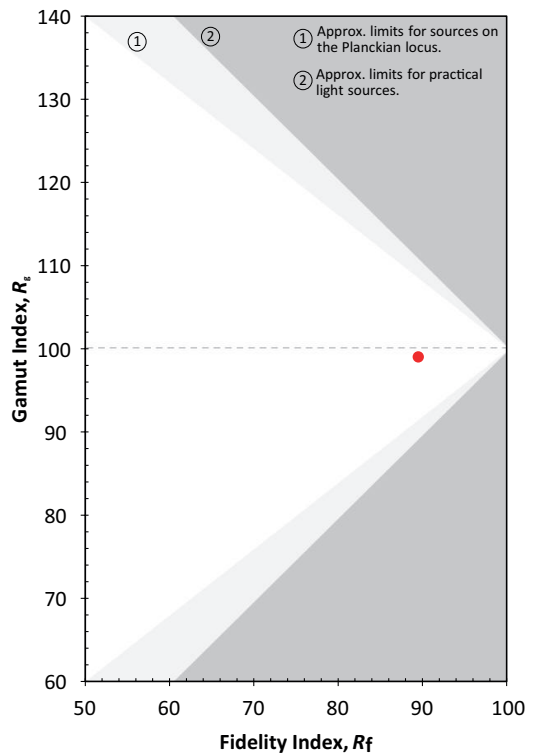

4,000 K

|        | x0     | y0     |
|--------|--------|--------|
| Center | 0.3818 | 0.3797 |

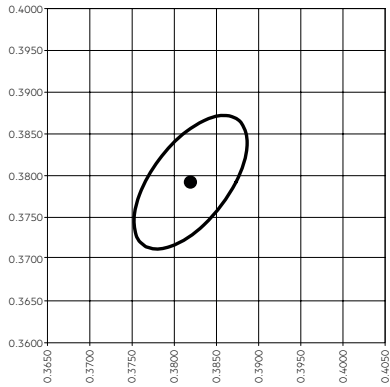

— MacAdam Ellipse: 3SDCM

| TM30 |    | CRI |    |
|------|----|-----|----|
| Rf   | Rg | Ra  | R9 |
| 89   | 99 | 91  | 54 |

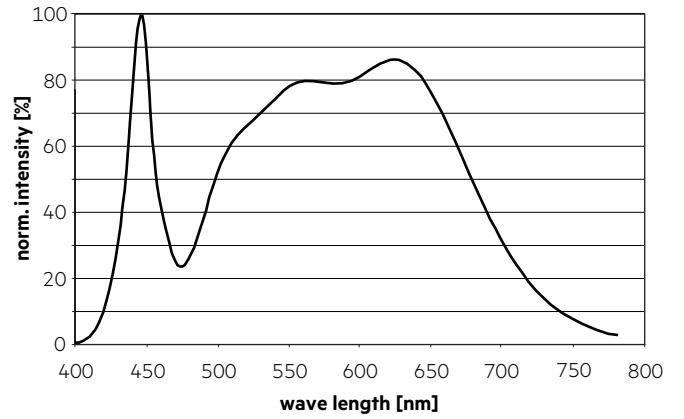

Colour vector graphic

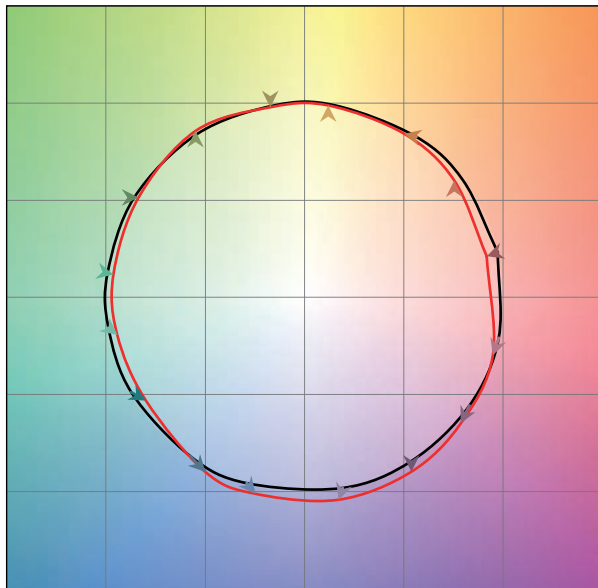

— Reference source  
— Test source

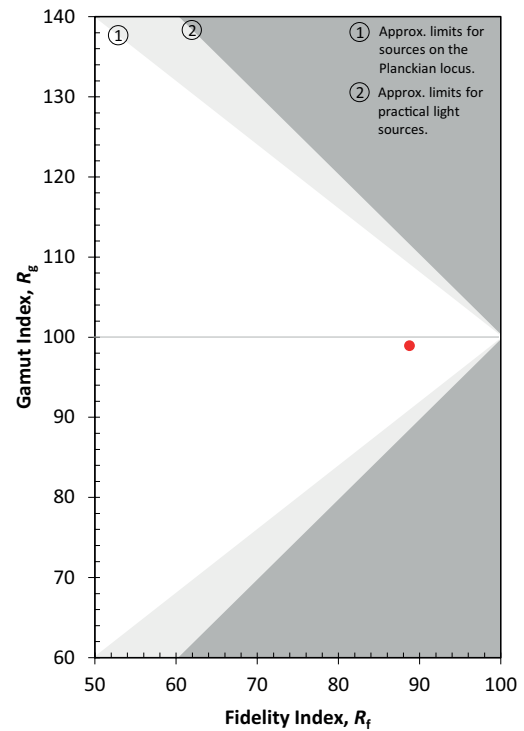

## 6.2 Light distribution

The optical design of the LLE product line ensures optimum homogeneity for the light distribution.

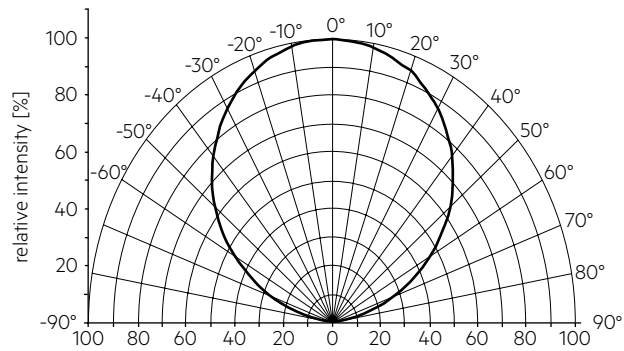

The colour temperature is measured integral over the complete module. The single LED light points can have deviations in the colour coordinates within MacAdam 5.

To ensure an ideal mixture of colours and a homogeneous light distribution a suitable optic (e. g. PMMA diffuser) and a sufficient spacing between module and optic (typ. 4 cm) should be used.

## 6.3 Relative luminous flux vs. tc temperature

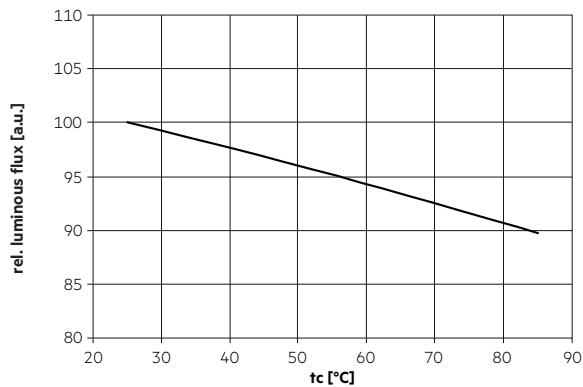

## 6.4 Relative luminous flux vs. operating current

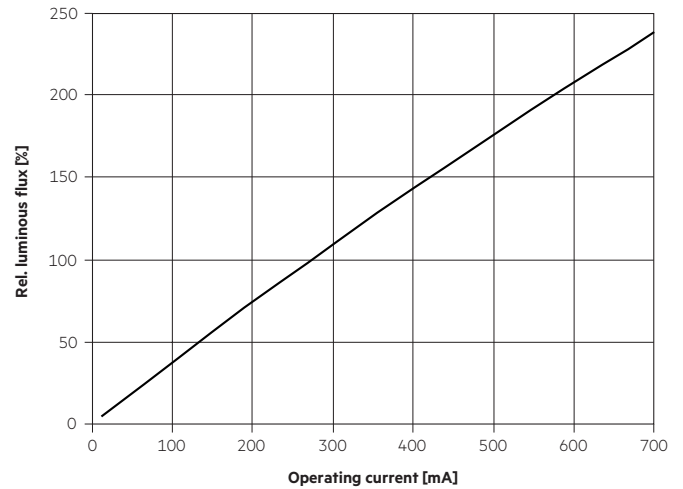

The diagrams are based on statistic values.  
The real values can be different.

## 7. Miscellaneous

### 7.1 Additional information

Additional technical information at [www.tridonic.com](http://www.tridonic.com) → Technical Data

Guarantee conditions at [www.tridonic.com](http://www.tridonic.com) → Services

Lifetime declarations are informative and represent no warranty claim.