

Module LLE 16mm 1250lm CRI90 HV ADV5

Modules LLE advanced

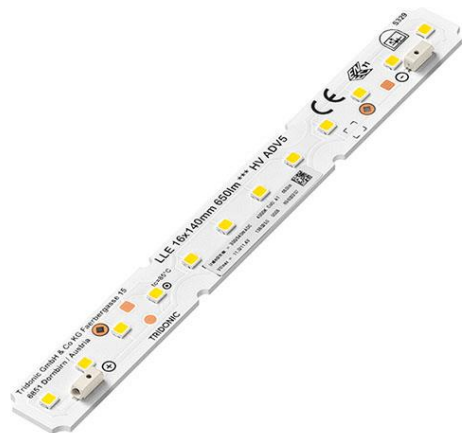

LLE 16x140mm 650lm HV ADV5



LLE 16x280mm 1250lm HV ADV5



LLE 16x560mm 2400lm HV ADV5

Product description

- _ Ideal for compact linear luminaire designs
- _ Homogenous illumination thanks to small package distance
- _ 2 terminals for serial wiring
- _ Perfectly uniform light, even if several LED modules are used together in a line
- _ Push terminals for quick and simple wiring of LED module to LED module
- _ HE ... High Efficiency, NM ... Nominal Mode, HO ... High Output
- _ Min. order quantity LLE 16x70mm 325lm 9xx HV ADV5 QTY4: 32 pcs. The LLE 16x70mm 325lm 9xx HV ADV5 module contains 4 single 16x70mm modules which have to be separated.
- _ Long lifetime up to 72,000 hours
- _ 5 years guarantee (conditions at <https://www.tridonic.com/manufacturer-guarantee-conditions>)

Optical properties

- _ Colour temperatures 2,700, 3,000 and 4,000 K
- _ Useful luminous flux 2,152 lm at Irated and tp = 25 °C
- _ Efficacy of the LED module 164 lm/W at Irated and tp = 25 °C
- _ High colour rendering index CRI > 90
- _ High colour consistency (MacAdam 3) ①
- _ Small luminous flux tolerances

Mechanical properties

- _ Module dimension 16 x 140 mm, 16 x 280 mm and 16 x 560 mm
- _ Simple installation via clips or screws

System solution

- _ Combine Tridonic's LED modules and dimmable drivers to achieve an outstanding system efficacy (configuration possible via <https://setbuilder.tridonic.com/>)

① Integral measurement over the complete module.

Website

<http://www.tridonic.com/28004001>

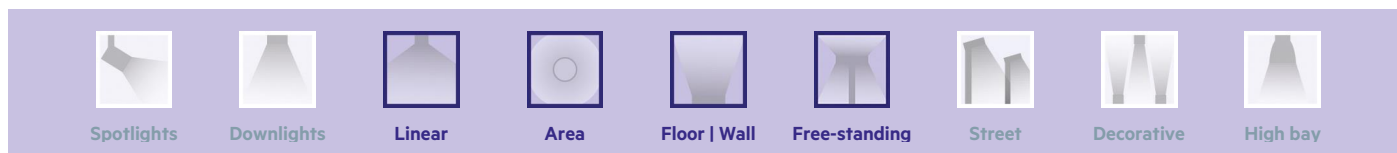
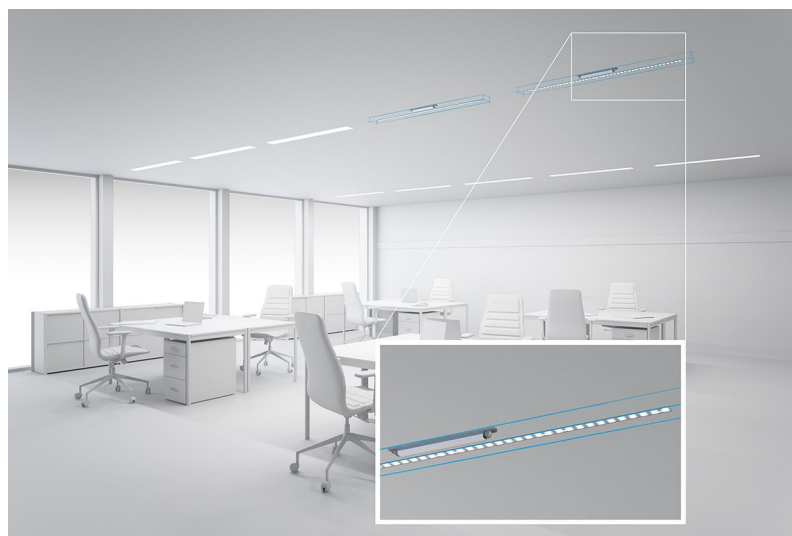

Module LLE 16mm 1250lm CRI90 HV ADV5

Modules LLE advanced

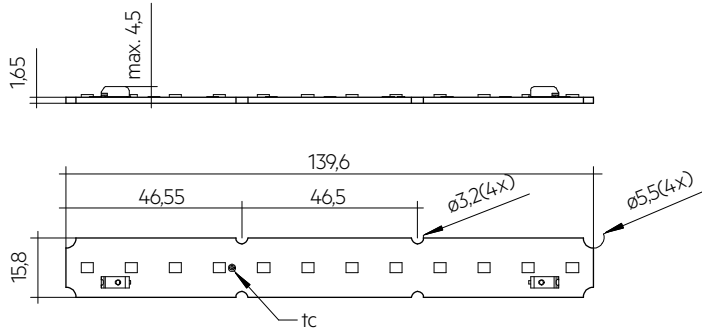

LLE 16x140mm 650lm HV ADV5

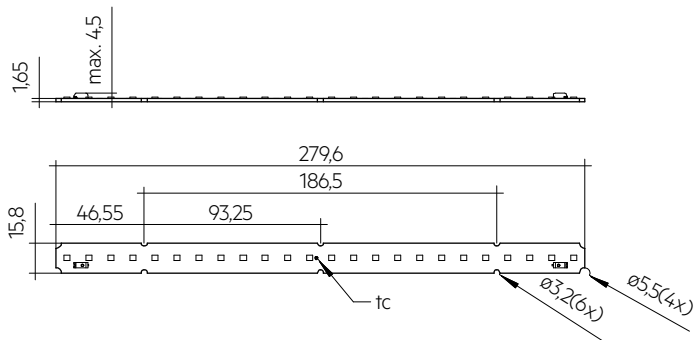

LLE 16x280mm 1250lm HV ADV5

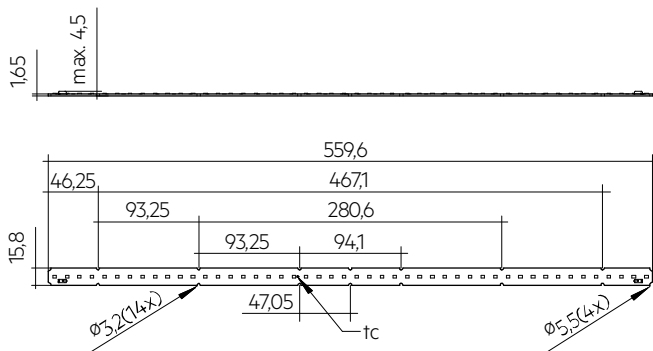

LLE 16x560mm 2400lm HV ADV5

Ordering data

Type	Article number	Article status	Colour temperature	Packaging, carton	Weight per pc.
LLE 16x70mm 325lm 930 HV ADV5 QTY4	28004001	On demand	3,000 K	144 pc(s).	0.017 kg
LLE 16x70mm 325lm 940 HV ADV5 QTY4	28004002	On demand	4,000 K	144 pc(s).	0.017 kg
LLE 16x140mm 650lm 927 HV ADV5	28004003	On demand	2,700 K	144 pc(s).	0.007 kg
LLE 16x140mm 650lm 930 HV ADV5	28004004	Standard	3,000 K	144 pc(s).	0.007 kg
LLE 16x140mm 650lm 935 HV ADV5	28004005	On demand	3,500 K	144 pc(s).	0.007 kg
LLE 16x140mm 650lm 940 HV ADV5	28004006	Standard	4,000 K	144 pc(s).	0.007 kg
LLE 16x280mm 1250lm 927 HV ADV5	28004007	Standard	2,700 K	144 pc(s).	0.014 kg
LLE 16x280mm 1250lm 930 HV ADV5	28004008	Standard	3,000 K	144 pc(s).	0.014 kg
LLE 16x280mm 1250lm 935 HV ADV5	28004009	On demand	3,500 K	144 pc(s).	0.014 kg
LLE 16x280mm 1250lm 940 HV ADV5	28004010	Standard	4,000 K	144 pc(s).	0.014 kg
LLE 16x560mm 2400lm 927 HV ADV5	28004011	On demand	2,700 K	144 pc(s).	0.028 kg
LLE 16x560mm 2400lm 930 HV ADV5	28004012	Standard	3,000 K	144 pc(s).	0.028 kg
LLE 16x560mm 2400lm 935 HV ADV5	28004013	On demand	3,500 K	144 pc(s).	0.028 kg
LLE 16x560mm 2400lm 940 HV ADV5	28004014	Standard	4,000 K	144 pc(s).	0.028 kg

Technical data

Beam characteristic	120°
Ambient temperature ta	-40 ... +65 °C
tp rated	50 °C
tc	85 °C
Irated	300 mA
I _{max}	540 mA
Max. permissible LF current ripple	595 mA
Max. permissible peak current	900 mA / max. 8 ms
Max. working voltage for insulation [®]	400 V
Insulation test voltage	1.8 kV
CTI of the printed circuit board	≥ 600
Colour tolerance	3 SDCM
ESD classification	Severity level 4
Risk group (IEC 62471) at ≤ 470 mA	RG0
Risk group (IEC 62471) at I _{max}	RG1
Classification acc. to IEC 62031	Built-in
Type of protection	IPO0
Lumen maintenance L70B50	72,000 h
Guarantee (conditions at www.tridonic.com)	5 Year(s)

Approval marks**Standards**

IEC 62031, IEC 62471, IEC 61000-4-2, IEC 62778, IEC 61547, UL 8750

Specific technical data

Type	Article number	Photometric code	Useful luminous flux at $t_p = 25^\circ\text{C}$ ^③	Expected luminous flux at t_p rated ^④	Typ. forward current	Min. forward voltage at t_p rated	Max. forward voltage at $t_p = 25^\circ\text{C}$	Power consumption P_{on} at $t_p = 25^\circ\text{C}$ ^⑤	Efficacy of the module at $t_p = 25^\circ\text{C}$	Expected efficacy of the module at t_p rated	Colour rendering index CRI
Operating mode HE at 200 mA											
LLE 16x70mm 325lm 930 HV ADV5 QTY4	28004001	930/359	-	171 lm	200 mA	5.1 V	5.7 V	-	-	155 lm/W	>>90
LLE 16x70mm 325lm 940 HV ADV5 QTY4	28004002	940/359	-	179 lm	200 mA	5.1 V	5.7 V	-	-	163 lm/W	>>90
LLE 16x140mm 650lm 927 HV ADV5	28004003	927/359	-	327 lm	200 mA	10.2 V	11.4 V	-	-	149 lm/W	>>90
LLE 16x140mm 650lm 930 HV ADV5	28004004	930/359	-	345 lm	200 mA	10.2 V	11.4 V	-	-	162 lm/W	>>90
LLE 16x140mm 650lm 935 HV ADV5	28004005	935/359	-	354 lm	200 mA	10.2 V	11.4 V	-	-	161 lm/W	>>90
LLE 16x140mm 650lm 940 HV ADV5	28004006	940/359	-	363 lm	200 mA	10.2 V	11.4 V	-	-	171 lm/W	>>90
LLE 16x280mm 1250lm 927 HV ADV5	28004007	927/359	-	654 lm	200 mA	20.4 V	22.7 V	-	-	152 lm/W	>>90
LLE 16x280mm 1250lm 930 HV ADV5	28004008	930/359	-	704 lm	200 mA	20.4 V	22.7 V	-	-	162 lm/W	>>90
LLE 16x280mm 1250lm 935 HV ADV5	28004009	935/359	-	710 lm	200 mA	20.4 V	22.7 V	-	-	165 lm/W	>>90
LLE 16x280mm 1250lm 940 HV ADV5	28004010	940/359	-	728 lm	200 mA	20.4 V	22.7 V	-	-	168 lm/W	>>90
LLE 16x560mm 2400lm 927 HV ADV5	28004011	927/359	-	1,309 lm	200 mA	40.9 V	45.3 V	-	-	150 lm/W	>>90
LLE 16x560mm 2400lm 930 HV ADV5	28004012	930/359	-	1,393 lm	200 mA	40.9 V	45.3 V	-	-	161 lm/W	>>90
LLE 16x560mm 2400lm 935 HV ADV5	28004013	935/359	-	1,419 lm	200 mA	40.9 V	45.3 V	-	-	163 lm/W	>>90
LLE 16x560mm 2400lm 940 HV ADV5	28004014	940/359	-	1,458 lm	200 mA	40.9 V	45.3 V	-	-	169 lm/W	>>90
Operating mode NM at 300 mA											
LLE 16x70mm 325lm 930 HV ADV5 QTY4	28004001	930/359	253 lm	246 lm	300 mA	5.2 V	5.8 V	1.7 W	149 lm/W	145 lm/W	>>90
LLE 16x70mm 325lm 940 HV ADV5 QTY4	28004002	940/359	264 lm	257 lm	300 mA	5.2 V	5.8 V	1.7 W	155 lm/W	151 lm/W	>>90
LLE 16x140mm 650lm 927 HV ADV5	28004003	927/359	484 lm	471 lm	300 mA	10.4 V	11.6 V	3.3 W	147 lm/W	143 lm/W	>>90
LLE 16x140mm 650lm 930 HV ADV5	28004004	930/359	512 lm	497 lm	300 mA	10.4 V	11.6 V	3.3 W	155 lm/W	152 lm/W	>>90
LLE 16x140mm 650lm 935 HV ADV5	28004005	935/359	524 lm	510 lm	300 mA	10.4 V	11.6 V	3.3 W	159 lm/W	155 lm/W	>>90
LLE 16x140mm 650lm 940 HV ADV5	28004006	940/359	542 lm	527 lm	300 mA	10.4 V	11.6 V	3.3 W	164 lm/W	161 lm/W	>>90
LLE 16x280mm 1250lm 927 HV ADV5	28004007	927/359	968 lm	941 lm	300 mA	20.8 V	23.1 V	6.7 W	144 lm/W	143 lm/W	>>90
LLE 16x280mm 1250lm 930 HV ADV5	28004008	930/359	1,038 lm	1,008 lm	300 mA	20.8 V	23.1 V	6.7 W	155 lm/W	152 lm/W	>>90
LLE 16x280mm 1250lm 935 HV ADV5	28004009	935/359	1,049 lm	1,021 lm	300 mA	20.8 V	23.1 V	6.7 W	157 lm/W	155 lm/W	>>90
LLE 16x280mm 1250lm 940 HV ADV5	28004010	940/359	1,080 lm	1,050 lm	300 mA	20.8 V	23.1 V	6.7 W	161 lm/W	158 lm/W	>>90
LLE 16x560mm 2400lm 927 HV ADV5	28004011	927/359	1,936 lm	1,883 lm	300 mA	41.7 V	46.2 V	13.3 W	146 lm/W	143 lm/W	>>90
LLE 16x560mm 2400lm 930 HV ADV5	28004012	930/359	2,055 lm	2,006 lm	300 mA	41.7 V	46.2 V	13.3 W	155 lm/W	152 lm/W	>>90
LLE 16x560mm 2400lm 935 HV ADV5	28004013	935/359	2,099 lm	2,042 lm	300 mA	41.7 V	46.2 V	13.3 W	158 lm/W	155 lm/W	>>90
LLE 16x560mm 2400lm 940 HV ADV5	28004014	940/359	2,152 lm	2,092 lm	300 mA	41.7 V	46.2 V	13.3 W	162 lm/W	159 lm/W	>>90
Operating mode HO at 500 mA											
LLE 16x70mm 325lm 930 HV ADV5 QTY4	28004001	930/359	-	397 lm	500 mA	5.3 V	6.0 V	-	-	142 lm/W	>>90
LLE 16x70mm 325lm 940 HV ADV5 QTY4	28004002	940/359	-	414 lm	500 mA	5.3 V	6.0 V	-	-	148 lm/W	>>90
LLE 16x140mm 650lm 927 HV ADV5	28004003	927/359	-	760 lm	500 mA	10.7 V	11.9 V	-	-	133 lm/W	>>90
LLE 16x140mm 650lm 930 HV ADV5	28004004	930/359	-	802 lm	500 mA	10.7 V	11.9 V	-	-	143 lm/W	>>90
LLE 16x140mm 650lm 935 HV ADV5	28004005	935/359	-	821 lm	500 mA	10.7 V	11.9 V	-	-	144 lm/W	>>90
LLE 16x140mm 650lm 940 HV ADV5	28004006	940/359	-	845 lm	500 mA	10.7 V	11.9 V	-	-	151 lm/W	>>90
LLE 16x280mm 1250lm 927 HV ADV5	28004007	927/359	-	1,519 lm	500 mA	21.5 V	23.8 V	-	-	133 lm/W	>>90
LLE 16x280mm 1250lm 930 HV ADV5	28004008	930/359	-	1,627 lm	500 mA	21.5 V	23.8 V	-	-	143 lm/W	>>90
LLE 16x280mm 1250lm 935 HV ADV5	28004009	935/359	-	1,647 lm	500 mA	21.5 V	23.8 V	-	-	144 lm/W	>>90
LLE 16x280mm 1250lm 940 HV ADV5	28004010	940/359	-	1,684 lm	500 mA	21.5 V	23.8 V	-	-	148 lm/W	>>90
LLE 16x560mm 2400lm 927 HV ADV5	28004011	927/359	-	3,038 lm	500 mA	43.1 V	47.6 V	-	-	134 lm/W	>>90
LLE 16x560mm 2400lm 930 HV ADV5	28004012	930/359	-	3,171 lm	500 mA	43.1 V	47.6 V	-	-	141 lm/W	>>90
LLE 16x560mm 2400lm 935 HV ADV5	28004013	935/359	-	3,294 lm	500 mA	43.1 V	47.6 V	-	-	145 lm/W	>>90
LLE 16x560mm 2400lm 940 HV ADV5	28004014	940/359	-	3,382 lm	500 mA	43.1 V	47.6 V	-	-	149 lm/W	>>90

② If mounted with M3 screws and plastic washers.

③ Tolerance of useful light flux - 0 % / + 15 %. Measurement uncertainty ± 10 %.

④ Tolerance of expected light flux - 0 % / + 15 %. Measurement uncertainty ± 10 %. Based on calculation.

⑤ Tolerance of power consumption P_{on} ± 10 %. Measurement uncertainty ± 5 %.

ACL BRIDGE LLE16

Accessory

**Product description**

- _ Clip for fixation for LLE16
- _ Fast snap on mounting (for sheet thickness 0.5 – 1.0 mm)
- _ For drilling hole 3 mm
- _ Clip made of polycarbonate
- _ Minimum sales quantity 200 pcs.

Website

<http://www.tridonic.com/28001035>

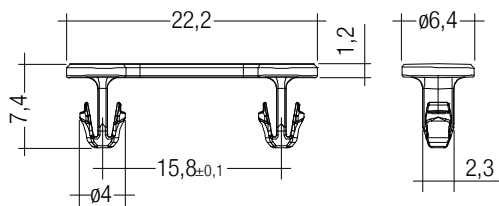
**Ordering data**

Type	Article number	Colour	Packaging, bag	Weight per pc.
ACL BRIDGE LLE16 PUSH-FIX	28001035	White	200 pc(s).	0.001 kg

ACL LINEAR COVER 16mm

Accessory

**Product description**

- _ LINEAR COVER for LLE 16
- _ Protection against direct touch for non-SELV applications (recommendation: use all fixing points) ^①
- _ Fast snap on mounting on to LLE 16 with clips or plastic washers
- _ High transmission: transparent, semi-transparent and diffuse
- _ Linear lense made of PMMA
- _ Tolerances LINEAR COVER: + 10 mm for 1,600 / 1,200 mm length (ends raw)

① Ends must be covered by the luminaire construction.

Website

<http://www.tridonic.com/28000950>

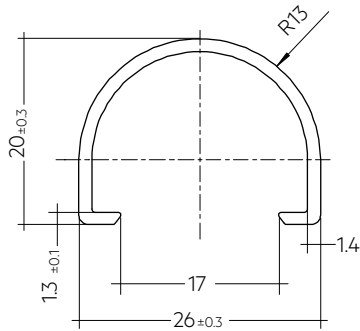
**Ordering data**

Type	Article number	Colour	Length L	Packaging, carton	Weight per pc.
ACL LINEAR COVER 16x1600mm FROSTED	28000950	Semi-transparent	1,600 mm	24 pc(s).	0.147 kg
ACL LINEAR COVER 16x1200mm FROSTED	28002827	Semi-transparent	1,200 mm	24 pc(s).	0.100 kg
ACL LINEAR COVER 16x1600mm DIFFUSE	28000951	Diffuse	1,600 mm	24 pc(s).	0.147 kg
ACL LINEAR COVER 16x1200mm DIFFUSE	28002828	Diffuse	1,200 mm	24 pc(s).	0.100 kg

1. Standards

IEC 62031
IEC 62471
IEC 61000-4-2
IEC 62778
IEC 61547
UL 8750 (for CLASS2 circuits and dry locations)

1.1 Photometric code

Key for photometric code, e. g. 830 / 349

1 st digit	2 nd + 3 rd digit	4 th digit	5 th digit	6 th digit		
Code	CRI	Colour temperature in Kelvin x 100	MacAdam initial	MacAdam after 25% of the lifetime (max.6000h)	Luminous flux after 25% of the lifetime (max.6000h)	
7	70 – 79				Code	Luminous flux
8	80 – 89				7	≥ 70 %
9	≥90				8	≥ 80 %
					9	≥ 90 %

1.2 Energy classification

Type	Colour temperature	Forward current	Energy classification	Energy consumption
LLE 16x70mm 325lm 930 HV ADV5 QTY4	3,000 K	300 mA	D	2 kWh / 1,000 h
LLE 16x70mm 325lm 940 HV ADV5 QTY4	4,000 K	300 mA	D	2 kWh / 1,000 h
LLE 16x140mm 650lm 927 HV ADV5	2,700 K	300 mA	D	4 kWh / 1,000 h
LLE 16x140mm 650lm 930 HV ADV5	3,000 K	300 mA	D	4 kWh / 1,000 h
LLE 16x140mm 650lm 935 HV ADV5	3,500 K	300 mA	D	4 kWh / 1,000 h
LLE 16x140mm 650lm 940 HV ADV5	4,000 K	300 mA	D	4 kWh / 1,000 h
LLE 16x280mm 1250lm 927 HV ADV5	2,700 K	300 mA	E	7 kWh / 1,000 h
LLE 16x280mm 1250lm 930 HV ADV5	3,000 K	300 mA	D	7 kWh / 1,000 h
LLE 16x280mm 1250lm 935 HV ADV5	3,500 K	300 mA	D	7 kWh / 1,000 h
LLE 16x280mm 1250lm 940 HV ADV5	4,000 K	300 mA	D	7 kWh / 1,000 h
LLE 16x560mm 2400lm 927 HV ADV5	2,700 K	300 mA	E	14 kWh / 1,000 h
LLE 16x560mm 2400lm 930 HV ADV5	3,000 K	300 mA	D	14 kWh / 1,000 h
LLE 16x560mm 2400lm 935 HV ADV5	3,500 K	300 mA	D	14 kWh / 1,000 h
LLE 16x560mm 2400lm 940 HV ADV5	4,000 K	300 mA	D	14 kWh / 1,000 h

Energy label and further information at www.tridonic.com in the certificates tab of the corresponding product page and at the EPREL data base <https://eprel.ec.europa.eu/>

2. Thermal details

2.1 tc point, ambient temperature and lifetime

The temperature at tp reference point is crucial for the light output and lifetime of a LED product.

For LLE a tp temperature of 50 °C has to be complied in order to achieve an optimum between heat sink requirements, light output and lifetime.

Compliance with the maximum permissible reference temperature at the tc point must be checked under operating conditions in a thermally stable state. The maximum value must be determined under worst-case conditions for the relevant application.

The tc and tp temperature of LED modules from Tridonic are measured at the same reference point.

2.2 Storage and humidity

Storage temperature	-40... +85 °C
---------------------	---------------

Operation only in non condensing environment.

Humidity during processing of the module should be between 30 to 70 %

Data sheet 05/25-LED625-5

Subject to change without notice.

2.3 Heat sink values

LLE 16x140mm 650lm ADV5

ta	tp	Forward current	R _{th, hs-a}	Cooling area
25 °C	50 °C	300 mA	1614 K/W	41 cm ²
25 °C	50 °C	500 mA	8.64 K/W	77 cm ²
35 °C	50 °C	300 mA	9.68 K/W	69 cm ²
35 °C	50 °C	500 mA	5.18 K/W	129 cm ²
40 °C	50 °C	300 mA	6.45 K/W	103 cm ²
40 °C	50 °C	500 mA	3.44 K/W	194 cm ²
45 °C	50 °C	300 mA	3.21 K/W	208 cm ²
45 °C	50 °C	500 mA	1.71 K/W	389 cm ²

LLE 16x280mm 1250lm ADV5

ta	tp	Forward current	R _{th, hs-a}	Cooling area
25 °C	50 °C	300 mA	8.19 K/W	81 cm ²
25 °C	50 °C	500 mA	4.36 K/W	153 cm ²
35 °C	50 °C	300 mA	4.91 K/W	136 cm ²
35 °C	50 °C	500 mA	2.61 K/W	255 cm ²
40 °C	50 °C	300 mA	3.27 K/W	204 cm ²
40 °C	50 °C	500 mA	1.74 K/W	383 cm ²
45 °C	50 °C	300 mA	1.63 K/W	409 cm ²
45 °C	50 °C	500 mA	0.86 K/W	771 cm ²

LLE 16x560mm 2400lm ADV5

ta	tp	Forward current	R _{th, hs-a}	Cooling area
25 °C	50 °C	300 mA	4.27 K/W	156 cm ²
25 °C	50 °C	500 mA	2.25 K/W	296 cm ²
35 °C	50 °C	300 mA	2.56 K/W	260 cm ²
35 °C	50 °C	500 mA	1.35 K/W	494 cm ²
40 °C	50 °C	300 mA	1.71 K/W	391 cm ²
40 °C	50 °C	500 mA	0.90 K/W	742 cm ²
45 °C	50 °C	300 mA	0.85 K/W	784 cm ²
45 °C	50 °C	500 mA	0.45 K/W	1,493 cm ²

Notes

The actual cooling surface can differ because of the material, the structural shape, outside influences and the installation situation. Depending on the heat sink a heat conducting paste or heat conducting film might be necessary to keep the specified tp temperature.

3. Installation / wiring

3.1 Electrical supply/choice of LED driver

LLE modules from Tridonic are not protected against overvoltages, overcurrents, overloads or short-circuit currents. Safe and reliable operation can only be guaranteed in conjunction with a LED driver which complies with the relevant standards. The use of LED driver from Tridonic in combination with LLE modules guarantees the necessary protection for safe and reliable operation.

If a LED driver other than Tridonic is used, it must provide the following protection:

- Short-circuit protection
- Overload protection
- Overtemperature protection



LLE modules must be supplied by a constant current LED driver. Operation with a constant voltage LED driver will lead to an irreversible damage of the module.

Wrong polarity can damage the LLE.

The LLE module is designed for serial wiring.

With parallel wiring tolerance-related differences in output are possible (thermal stress of the module) and can cause differences in brightness.

If a wire breaks or a complete module fails then the current passing through the other module increases. This may reduce its life considerably.

The max. permissible output current of the LED driver for parallel wiring is 1,080 mA.

Parallel wiring is only permitted with 280 mm or 560 mm modules.

LLE can be operated either from SELV LED drivers or from LED drivers with LV output voltage.



LLE are basic insulated up to 400 V (if mounted with M3 screws with head diameter 7 mm in combination with plastic washers) against ground and can be mounted directly on earthed metal parts of the luminaire. If the max. output voltage of the LED driver (also against earth) is above 400 V, an additional insulation between LED module and heat sink is required (for example by insulated thermal pads) or by a suitable luminaire construction.

At voltages > 60 V an additional protection against direct touch (test finger) to the light emitting side of the module has to be guaranteed.

This is typically achieved by means of a non removable light distributor over the module.

3.2 Wiring



Wiring examples for serial wiring

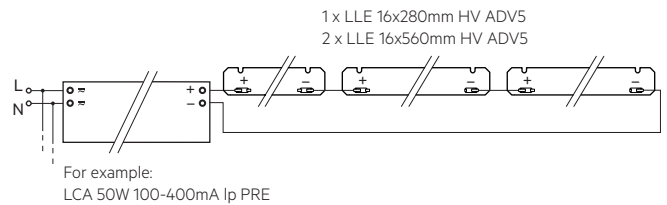
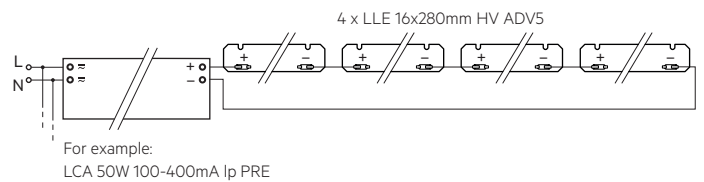

Wiring examples for parallel wiring

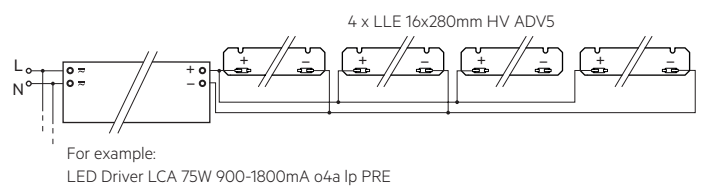

3.3 Wiring type and cross section

For wiring use solid wire from 0.14 to 0.5 mm².

No reconnection with smaller diameters possible if used with >0.34 mm².

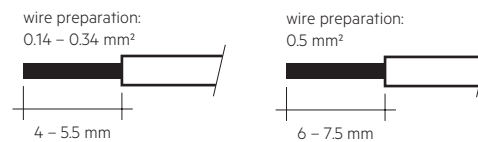

To remove the wires use a suitabel tool (Wago 206-859) or through twist and pull.

3.4 Mounting instruction



None of the components of the LLE (substrate, LED, electronic components etc.) may be exposed to tensile or compressive stresses.

Max. torque for fixing: 0.5 Nm.

The LED modules are mounted onto a heat sink with min. 6 M3 screws with plastic washers per module or ACL BRIDGE LLE16 PUSH-FIX.

Only touch the module at the edge to separate the modules (see marking below).



Chemical substance may harm the LED module. Chemical reactions could lead to colour shift, reduced luminous flux or a total failure of the module caused by corrosion of electrical connections.

Materials which are used in LED applications (e.g. sealings, adhesives) must not produce dissolver gas. They must not be condensation curing based, acetate curing based or contain sulfur, chlorine or phthalate.

Avoid corrosive atmosphere during usage and storage.

3.5 EOS/ESD safety guidelines



The device / module contains components that are sensitive to electrostatic discharge and may only be installed in the factory and on site if appropriate EOS/ESD protection measures have been taken. No special measures need be taken for devices/modules with enclosed casings (contact with the pc board not possible), just normal installation practice. Please note the requirements set out in the document EOS / ESD guidelines (Guideline_EOS_ESD.pdf) at: <http://www.tridonic.com/esd-protection>

4. Lifetime

4.1 Lifetime, lumen maintenance and failure rate

The light output of an LED module decreases over the lifetime, this is characterized with the L value.

L70 means that the LED module will give 70 % of its initial luminous flux.

This value is always related to the number of operation hours and therefore defines the lifetime of an LED module.

As the L value is a statistical value and the lumen maintenance may vary over the delivered LED modules.

The B value defines the amount of modules which are below the specific L value, e.g. L70B10 means 10 % of the LED modules are below 70 % of the initial luminous flux, respectively 90 % will be above 70 % of the initial value.

In addition the percentage of failed modules (fatal failure) is characterized by the C value.

The F value is the combination of the B and C value. That means for F degradation and complete failures are considered, e.g. L70F10 means 10 % of the LED modules may fail or be below 70 % of the initial luminous flux.

4.2 Lumen maintenance for LLE 16mm HV ADV5

Forward current	tp tempera- ture	tp						
		L90 / F10	L90 / F50	L80 / F10	L80 / F50	L70 / F10	L70 / F50	
150 mA	40 °C	43,000 h	59,000 h	>72,000 h	>72,000 h	>72,000 h	>72,000 h	
	45 °C	42,000 h	57,000 h	>72,000 h	>72,000 h	>72,000 h	>72,000 h	
	50 °C	41,000 h	55,000 h	>72,000 h	>72,000 h	>72,000 h	>72,000 h	
	55 °C	40,000 h	54,000 h	>72,000 h	>72,000 h	>72,000 h	>72,000 h	
	60 °C	39,000 h	52,000 h	>72,000 h	>72,000 h	>72,000 h	>72,000 h	
	65 °C	38,000 h	50,000 h	>72,000 h	>72,000 h	>72,000 h	>72,000 h	
	70 °C	38,000 h	49,000 h	>72,000 h	>72,000 h	>72,000 h	>72,000 h	
	75 °C	37,000 h	47,000 h	>72,000 h	>72,000 h	>72,000 h	>72,000 h	
	80 °C	36,000 h	46,000 h	>72,000 h	>72,000 h	>72,000 h	>72,000 h	
	85 °C	35,000 h	45,000 h	>72,000 h	>72,000 h	>72,000 h	>72,000 h	
	200 mA	40 °C	43,000 h	58,000 h	>72,000 h	>72,000 h	>72,000 h	>72,000 h
		45 °C	42,000 h	57,000 h	>72,000 h	>72,000 h	>72,000 h	>72,000 h
		50 °C	41,000 h	55,000 h	>72,000 h	>72,000 h	>72,000 h	>72,000 h
55 °C		40,000 h	53,000 h	>72,000 h	>72,000 h	>72,000 h	>72,000 h	
60 °C		39,000 h	51,000 h	>72,000 h	>72,000 h	>72,000 h	>72,000 h	
65 °C		38,000 h	50,000 h	>72,000 h	>72,000 h	>72,000 h	>72,000 h	
70 °C		37,000 h	48,000 h	>72,000 h	>72,000 h	>72,000 h	>72,000 h	
75 °C		36,000 h	47,000 h	>72,000 h	>72,000 h	>72,000 h	>72,000 h	
80 °C		36,000 h	45,000 h	>72,000 h	>72,000 h	>72,000 h	>72,000 h	
85 °C		35,000 h	44,000 h	>72,000 h	>72,000 h	>72,000 h	>72,000 h	
300 mA		40 °C	42,000 h	58,000 h	>72,000 h	>72,000 h	>72,000 h	>72,000 h
		45 °C	41,000 h	56,000 h	>72,000 h	>72,000 h	>72,000 h	>72,000 h
		50 °C	40,000 h	54,000 h	>72,000 h	>72,000 h	>72,000 h	>72,000 h
	55 °C	40,000 h	52,000 h	>72,000 h	>72,000 h	>72,000 h	>72,000 h	
	60 °C	39,000 h	51,000 h	>72,000 h	>72,000 h	>72,000 h	>72,000 h	
	65 °C	38,000 h	49,000 h	>72,000 h	>72,000 h	>72,000 h	>72,000 h	
	70 °C	37,000 h	48,000 h	>72,000 h	>72,000 h	>72,000 h	>72,000 h	
	75 °C	36,000 h	46,000 h	>72,000 h	>72,000 h	>72,000 h	>72,000 h	
	80 °C	35,000 h	45,000 h	>72,000 h	>72,000 h	>72,000 h	>72,000 h	
	85 °C	34,000 h	44,000 h	70,000 h	>72,000 h	>72,000 h	>72,000 h	

Forward current	tp tempera- ture	tp						
		L90 / F10	L90 / F50	L80 / F10	L80 / F50	L70 / F10	L70 / F50	
375 mA	40 °C	42,000 h	57,000 h	>72,000 h	>72,000 h	>72,000 h	>72,000 h	
	45 °C	41,000 h	55,000 h	>72,000 h	>72,000 h	>72,000 h	>72,000 h	
	50 °C	40,000 h	54,000 h	>72,000 h	>72,000 h	>72,000 h	>72,000 h	
	55 °C	39,000 h	52,000 h	>72,000 h	>72,000 h	>72,000 h	>72,000 h	
	60 °C	38,000 h	50,000 h	>72,000 h	>72,000 h	>72,000 h	>72,000 h	
	65 °C	37,000 h	49,000 h	>72,000 h	>72,000 h	>72,000 h	>72,000 h	
	70 °C	37,000 h	47,000 h	>72,000 h	>72,000 h	>72,000 h	>72,000 h	
	75 °C	36,000 h	46,000 h	>72,000 h	>72,000 h	>72,000 h	>72,000 h	
	80 °C	35,000 h	44,000 h	71,000 h	>72,000 h	>72,000 h	>72,000 h	
	85 °C	34,000 h	43,000 h	69,000 h	>72,000 h	>72,000 h	>72,000 h	
	450 mA	40 °C	42,000 h	56,000 h	>72,000 h	>72,000 h	>72,000 h	>72,000 h
		45 °C	41,000 h	55,000 h	>72,000 h	>72,000 h	>72,000 h	>72,000 h
		50 °C	40,000 h	53,000 h	>72,000 h	>72,000 h	>72,000 h	>72,000 h
55 °C		39,000 h	51,000 h	>72,000 h	>72,000 h	>72,000 h	>72,000 h	
60 °C		38,000 h	50,000 h	>72,000 h	>72,000 h	>72,000 h	>72,000 h	
65 °C		37,000 h	48,000 h	>72,000 h	>72,000 h	>72,000 h	>72,000 h	
70 °C		36,000 h	47,000 h	>72,000 h	>72,000 h	>72,000 h	>72,000 h	
75 °C		35,000 h	45,000 h	>72,000 h	>72,000 h	>72,000 h	>72,000 h	
80 °C		35,000 h	44,000 h	70,000 h	>72,000 h	>72,000 h	>72,000 h	
85 °C		34,000 h	43,000 h	69,000 h	>72,000 h	>72,000 h	>72,000 h	
500 mA		40 °C	41,000 h	56,000 h	>72,000 h	>72,000 h	>72,000 h	>72,000 h
		45 °C	40,000 h	54,000 h	>72,000 h	>72,000 h	>72,000 h	>72,000 h
		50 °C	39,000 h	52,000 h	>72,000 h	>72,000 h	>72,000 h	>72,000 h
	55 °C	38,000 h	51,000 h	>72,000 h	>72,000 h	>72,000 h	>72,000 h	
	60 °C	38,000 h	49,000 h	>72,000 h	>72,000 h	>72,000 h	>72,000 h	
	65 °C	37,000 h	48,000 h	>72,000 h	>72,000 h	>72,000 h	>72,000 h	
	70 °C	36,000 h	46,000 h	>72,000 h	>72,000 h	>72,000 h	>72,000 h	
	75 °C	35,000 h	45,000 h	71,000 h	>72,000 h	>72,000 h	>72,000 h	
	80 °C	34,000 h	43,000 h	70,000 h	>72,000 h	>72,000 h	>72,000 h	
	85 °C	34,000 h	42,000 h	68,000 h	>72,000 h	>72,000 h	>72,000 h	

4.3 Switching capability

100,000 cycles

Tridonic test according to IEC 62717 Cl 10.3.3

30 s on / 30 s off at Imax

5. Electrical values

5.1 Declaration of electrical parameters

Irated ... Nominal operating current the module is designed for.

I_{max} ... Max. permissible continuous operating current incl. The tolerances of the LED driver.

Max. permissible LF current ripple ... Max. output current of the LED driver incl. Tolerances and LF current ripple must not exceed this value.

Max. permissible peak current ... The max. output peak current of the LED driver must not exceed this value.

5.2 Typ. forward voltage vs. forward current

LLE 16x140mm 650lm 9xx HV ADV5

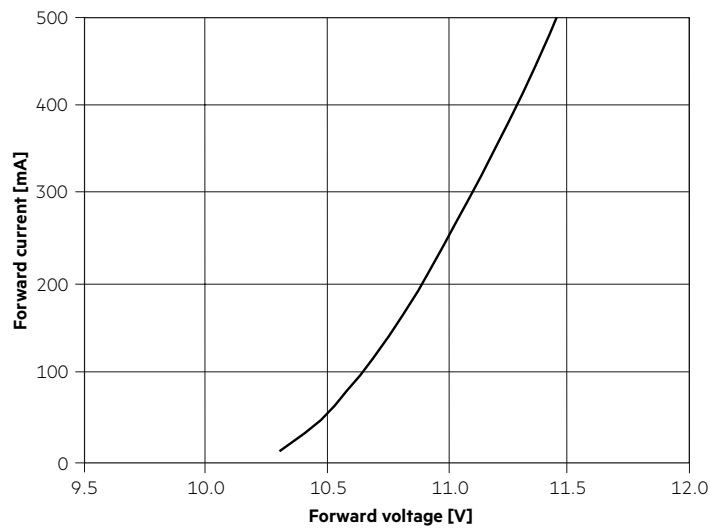

LLE 16x280mm 1250lm 9xx HV ADV5

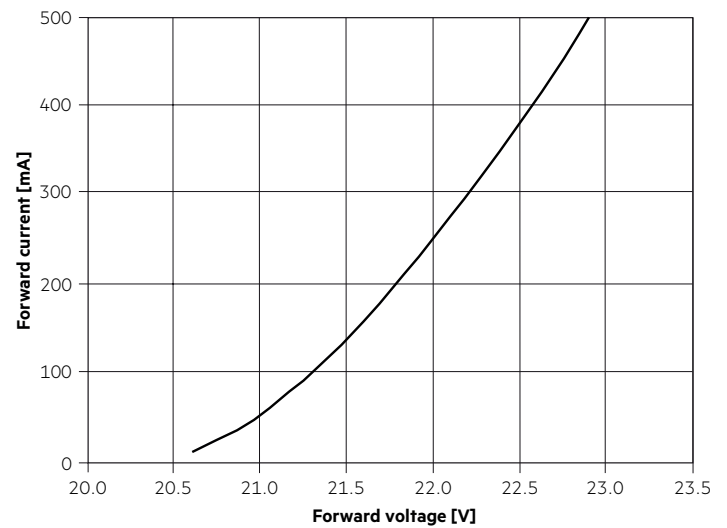

LLE 16x560mm 2400lm 9xx HV ADV5

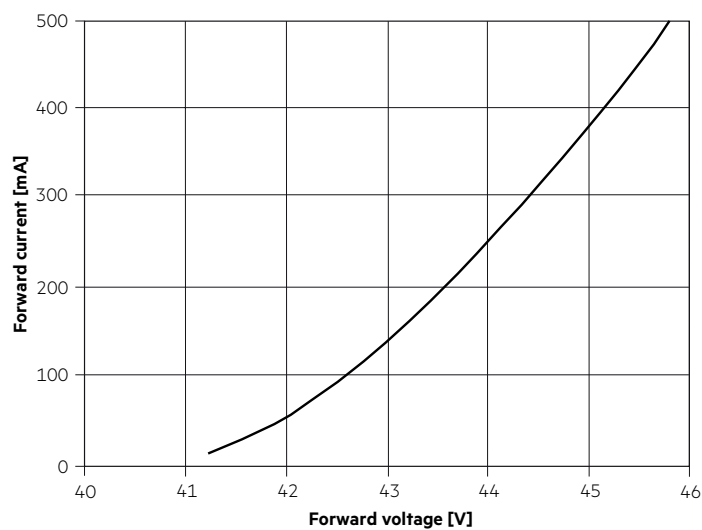

The diagrams are based on statistic values.
The real values can be different.

5.3 Forward voltage vs. tc temperature

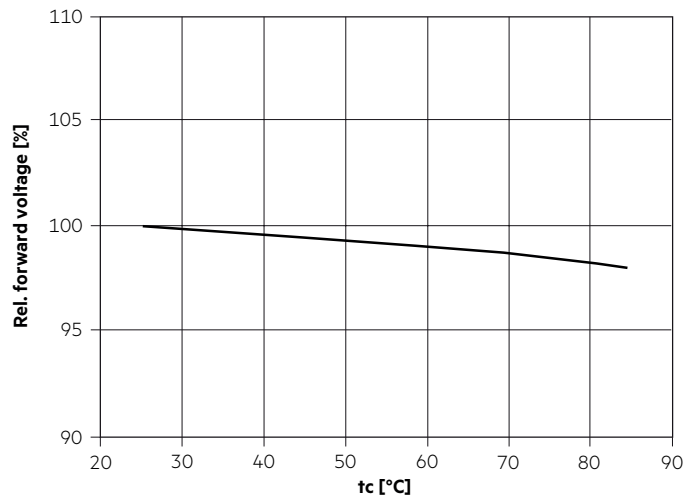

The diagrams are based on statistic values.
The real values can be different.

6. Photometric characteristics

6.1 Coordinates and tolerances according to CIE 1931

The specified colour coordinates are integral measured by current impulse of 195 mA and a duration of 100 ms.
 The ambient temperature of the measurement is $t_a = 25^\circ\text{C}$.
 The measurement tolerance of the colour coordinates are ± 0.01 .

2,700 K

	x0	y0
Centre	0.4578	0.4101

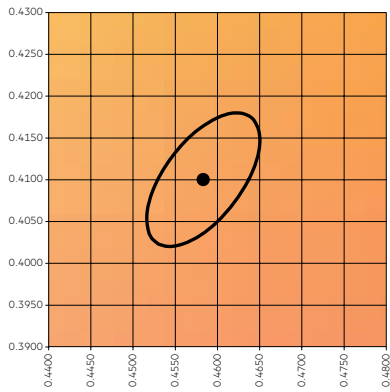

— MacAdam Ellipse: 3SDCM

TM30		CRI	
Rf	Rg	Ra	R9
91	99	93	57

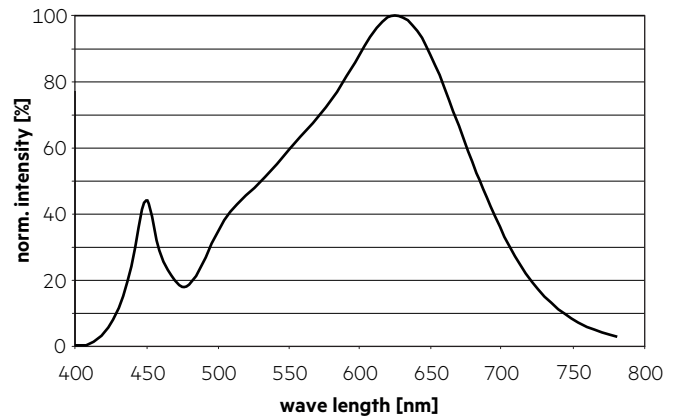

Colour vector graphic

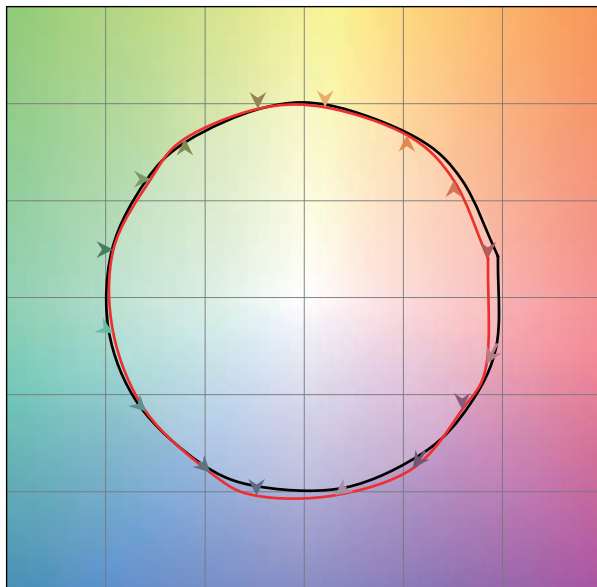

— Reference source
 — Test source

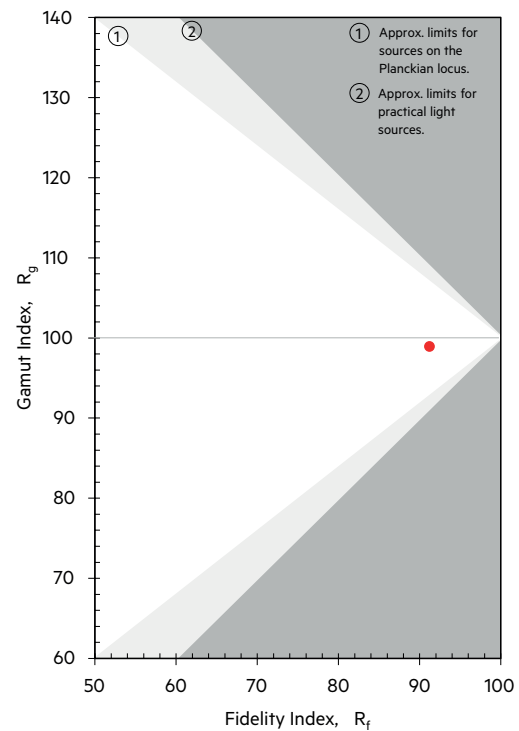

3,000 K

	x0	y0
Centre	0.4338	0.4030

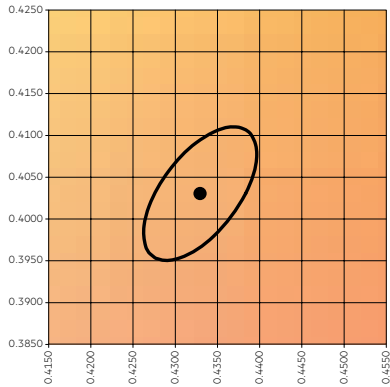

— MacAdam Ellipse: 3SDCM

TM30		CRI	
Rf	Rg	Ra	R9
90	98	92	57

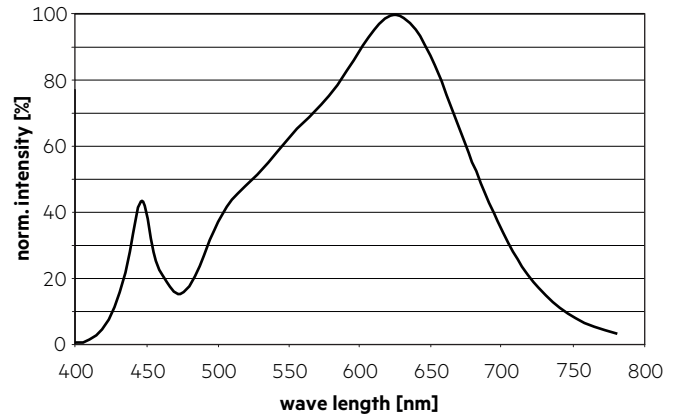

Colour vector graphic

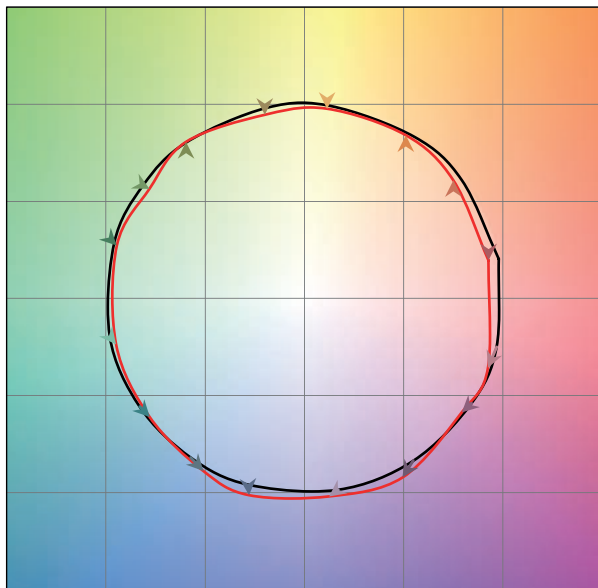

— Reference source
— Test source

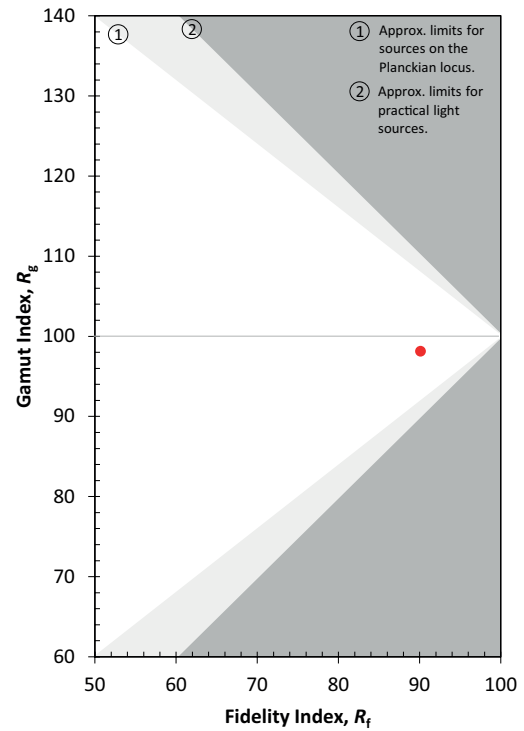

3,500 K

	x0	y0
Centre	0.4073	0.3917

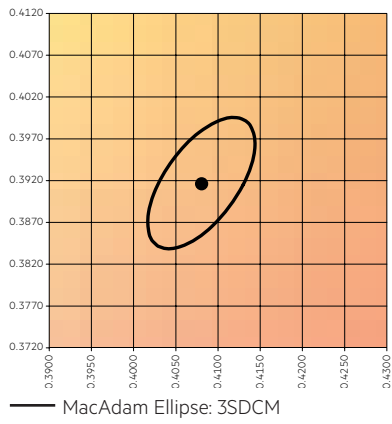

TM30		CRI	
Rf	Rg	Ra	R9
90	99	93	63

Colour vector graphic

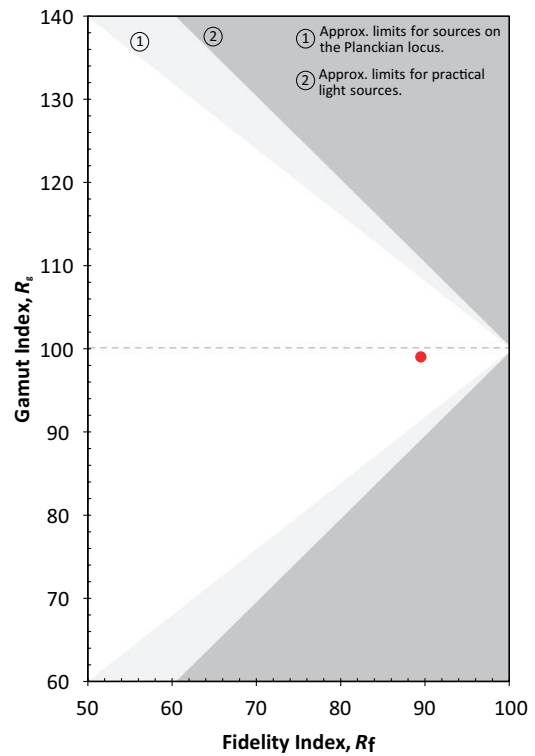
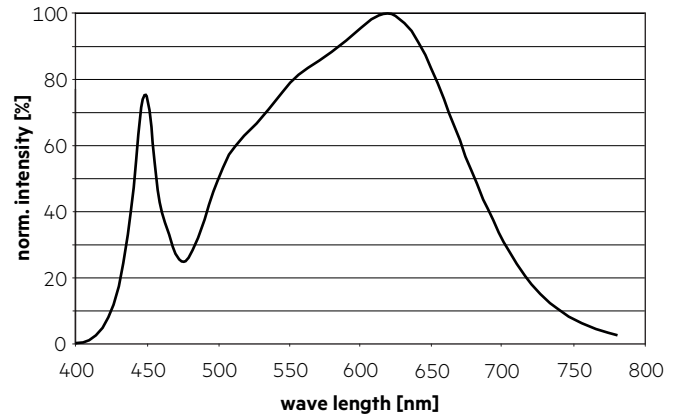
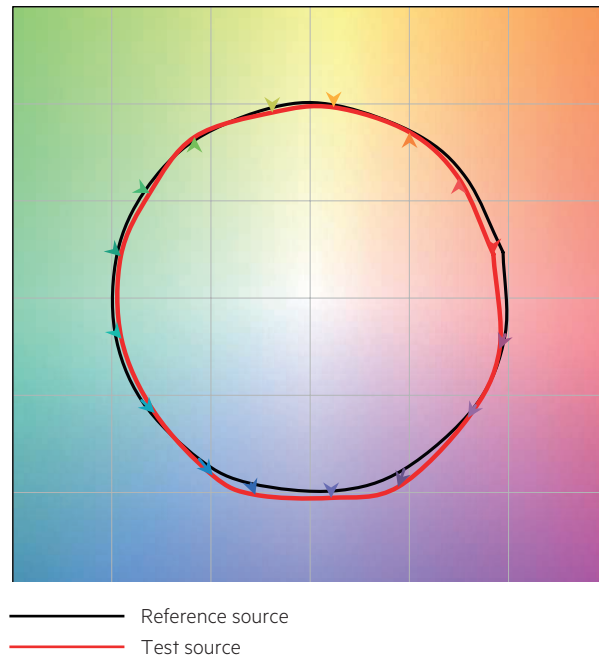

4,000 K

	x0	y0
Center	0.3818	0.3797

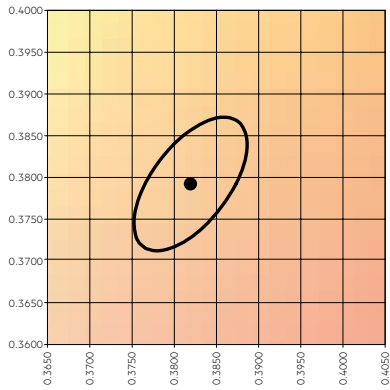

— MacAdam Ellipse: 3SDCM

TM30		CRI	
Rf	Rg	Ra	R9
89	99	91	54

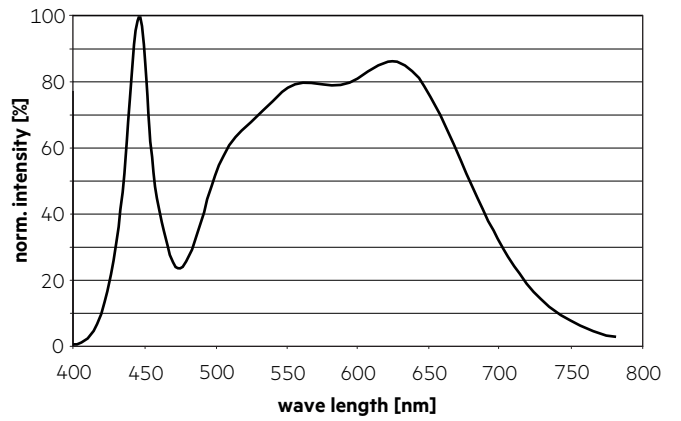

Colour vector graphic

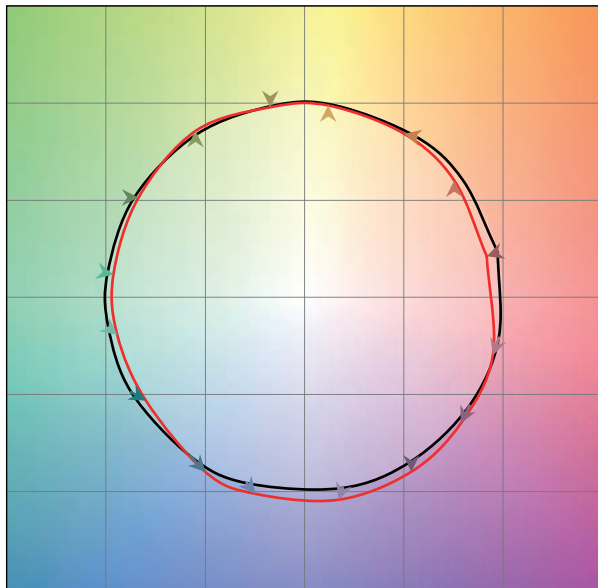

— Reference source
— Test source

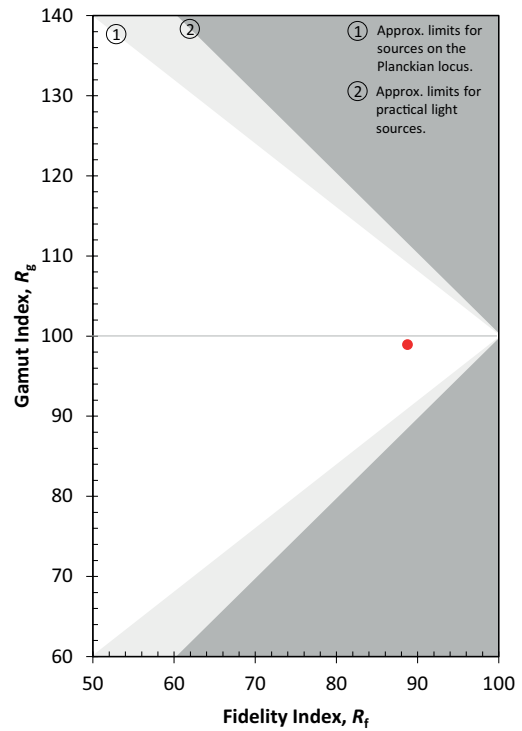

6.2 Light distribution

The optical design of the LLE product line ensures optimum homogeneity for the light distribution.

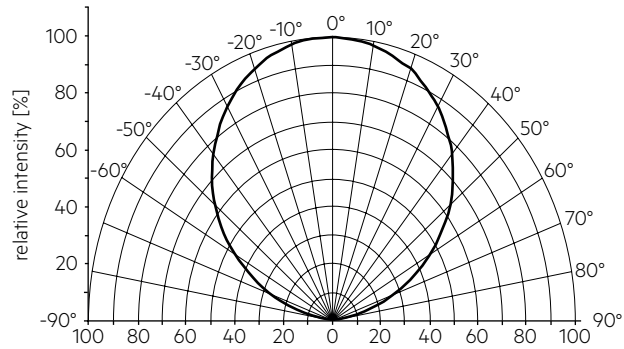

The colour temperature is measured integral over the complete module. The single LED light points can have deviations in the colour coordinates within MacAdam 5. To ensure an ideal mixture of colours and a homogeneous light distribution a suitable optic (e. g. PMMA diffuser) and a sufficient spacing between module and optic (typ. 4 cm) should be used.

6.3 Relative luminous flux vs. tc temperature

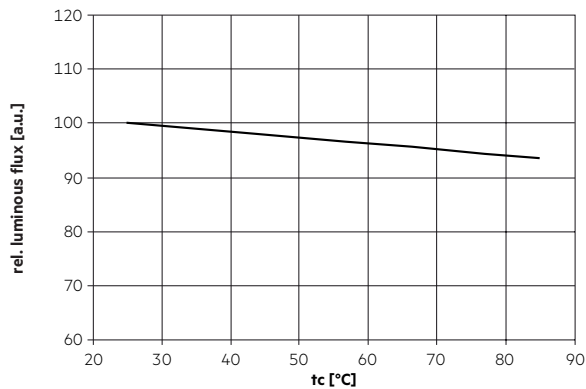

6.4 Relative luminous flux vs. operating current

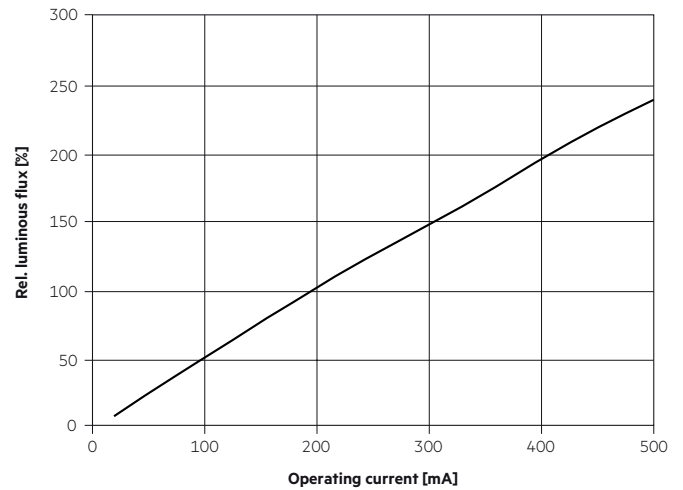

The diagrams are based on statistic values. The real values can be different.

7. Miscellaneous

7.1 Additional information

Additional technical information at www.tridonic.com → Technical Data

Guarantee conditions at www.tridonic.com → Services

Lifetime declarations are informative and represent no warranty claim.