

Module DLE G4 ADV

Modules DLE advanced



With housing



Without housing

Product description

- _ For downlights
- _ Safety glass for 5,000 lm version
- _ Built-in LED module
- _ Cooling required
- _ Flexible operating mode
- _ HE ... High Efficiency, NM ... Nominal Mode, HO ... High Output

Optical properties

- _ Colour temperatures 3,000 and 4,000 K
- _ Useful luminous flux 3,318 lm at Irated and tp = 25 °C
- _ Efficacy of the LED module 176 lm/W at Irated and tp = 25 °C
- _ High colour rendering index CRI > 80
- _ High colour consistency (MacAdam 3)
- _ Small luminous flux tolerances

Mechanical properties

- _ Fixing holes for M3 screws

System solution

- _ Combine Tridonic's LED modules and dimmable drivers to achieve an outstanding system efficacy (configuration possible via <https://setbuilder.tridonic.com/>)

Website

<http://www.tridonic.com/89602870>



Linear



High bay



Decorative



Downlights



Spotlights



Free-standing



Area



Floor | Wall



Street

Module DLE G4 ADV

Modules DLE advanced

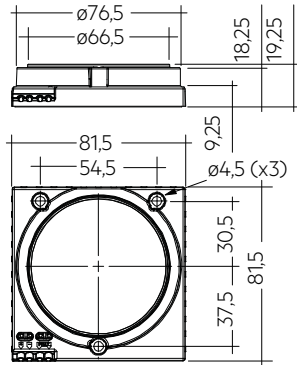

With housing (tc/tp position same as without housing) – Dimensions in mm

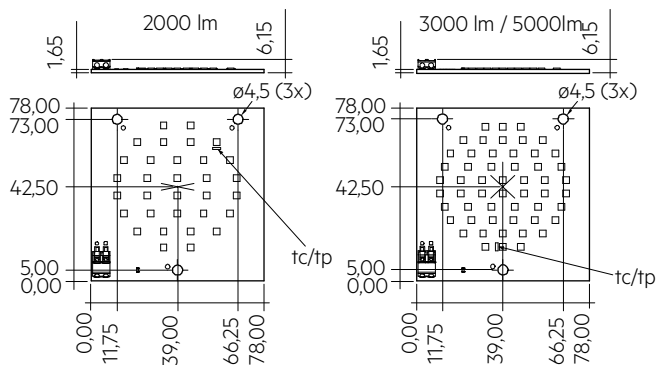

Without housing – Dimensions in mm

Ordering data

Type	Article number	Colour temperature	Housing	Packaging, carton	Weight per pc.
DLE G4 65mm 2000lm 830 R ADV	89602870	3,000 K	No	30 pc(s).	0.029 kg
DLE G4 65mm 2000lm 840 R ADV	89602871	4,000 K	No	30 pc(s).	0.029 kg
DLE G4 65mm 3000lm 830 R ADV	89602872	3,000 K	No	30 pc(s).	0.029 kg
DLE G4 65mm 3000lm 840 R ADV	89602873	4,000 K	No	30 pc(s).	0.029 kg
DLE G4 65mm 2000lm 830 H ADV	89602874	3,000 K	Yes	10 pc(s).	0.060 kg
DLE G4 65mm 2000lm 840 H ADV	89602875	4,000 K	Yes	10 pc(s).	0.060 kg
DLE G4 65mm 3000lm 830 H ADV	89602876	3,000 K	Yes	10 pc(s).	0.060 kg
DLE G4 65mm 3000lm 840 H ADV	89602877	4,000 K	Yes	10 pc(s).	0.060 kg
DLE G4 65mm 5000lm 830 H ADV	89603014	3,000 K	Yes	10 pc(s).	0.075 kg
DLE G4 65mm 5000lm 840 H ADV	89603015	4,000 K	Yes	10 pc(s).	0.075 kg

Technical data

Beam characteristic with housing	100°
Beam characteristic without housing	116°
Ambient temperature t_a	-20 ... +45 °C
t_p rated	65 °C
t_c	up to 85 °C
I rated for 2,000 lm	500 mA
I rated for 3,000 lm with housing	550 mA
I rated for 3,000 lm without housing	550 mA
I rated for 5,000 lm with housing	750 mA
I _{max} for 2,000 lm	935 mA
I _{max} for 3,000 lm with housing	700 mA
I _{max} for 3,000 lm without housing	1,290 mA
I _{max} for 5,000 lm with housing	1,290 mA
Max. permissible LF current ripple for 2,000 lm	1,030 mA
Max. permissible LF current ripple for 3,000 lm with housing	770 mA
Max. permissible LF current ripple for 3,000 lm without housing	1,420 mA
Max. permissible LF current ripple for 5,000 lm with housing	1,420 mA
Max. permissible peak current for 2,000 lm	2,400 mA / max. 5 ms
Max. permissible peak current for 3,000 lm with housing	2,700 mA / max. 5 ms
Max. permissible peak current for 3,000 lm without housing	2,700 mA / max. 5 ms
Max. permissible peak current for 5,000 lm with housing	2,700 mA / max. 5 ms
Max. working voltage for insulation SELV ^①	< 60 V
Insulation test voltage	0.5 kV
Colour tolerance	3 SDCM
ESD classification	Severity level 1
Risk group (IEC 62471)	RG1
Type of protection	IP00
Lumen maintenance L70B50	50,000 h
Guarantee (conditions at www.tridonic.com)	5 Year(s)

Approval marks**Standards**

IEC 62031, IEC 62471, IEC 62778, IEC 61547

Specific technical data

Type	Article number	Photometric code	Useful luminous flux at tp = 25 °C	Expected luminous flux at tp rated	Typ. forward current	Min. forward voltage at tp rated	Max. forward voltage at tp = 25 °C	Power consumption Pon at tp = 25 °C	Efficacy of the module at tp = 25 °C	Expected efficacy of the module at tp rated	Colour rendering index CRI
DLE G4 65mm 2000lm – Module without housing – Operating mode HE											
DLE G4 65mm 2000lm 830 R ADV	89602870	830/359	-	1,425 lm	400 mA	21.2 V	22.9 V	-	-	159 lm/W	>80
DLE G4 65mm 2000lm 840 R ADV	89602871	840/359	-	1,311 lm	350 mA	21.1 V	22.8 V	-	-	170 lm/W	>80
DLE G4 65mm 2000lm – Module without housing – Operating mode NM											
DLE G4 65mm 2000lm 830 R ADV	89602870	830/359	1,900 lm	1,764 lm	500 mA	21.5 V	23.2 V	11.5 W	165 lm/W	156 lm/W	>80
DLE G4 65mm 2000lm 840 R ADV	89602871	840/359	1,995 lm	1,850 lm	500 mA	21.5 V	23.2 V	11.5 W	173 lm/W	164 lm/W	>80
DLE G4 65mm 2000lm – Module without housing – Operating mode HO											
DLE G4 65mm 2000lm 830 R ADV	89602870	830/359	-	2,404 lm	700 mA	22.1 V	23.8 V	-	-	150 lm/W	>80
DLE G4 65mm 2000lm 840 R ADV	89602871	840/359	-	2,352 lm	650 mA	21.9 V	23.7 V	-	-	158 lm/W	>80
DLE G4 65mm 3000lm – Module without housing – Operating mode HE											
DLE G4 65mm 3000lm 830 R ADV	89602872	830/359	-	2,423 lm	450 mA	31.9 V	34.4 V	-	-	163 lm/W	>80
DLE G4 65mm 3000lm 840 R ADV	89602873	840/359	-	2,534 lm	450 mA	31.9 V	34.4 V	-	-	170 lm/W	>80
DLE G4 65mm 3000lm – Module without housing – Operating mode NM											
DLE G4 65mm 3000lm 830 R ADV	89602872	830/359	3,175 lm	2,941 lm	550 mA	32.2 V	34.8 V	18.9 W	168 lm/W	159 lm/W	>80
DLE G4 65mm 3000lm 840 R ADV	89602873	840/359	3,318 lm	3,076 lm	550 mA	32.2 V	34.8 V	18.9 W	176 lm/W	167 lm/W	>80
DLE G4 65mm 3000lm – Module without housing – Operating mode HO											
DLE G4 65mm 3000lm 830 R ADV	89602872	830/359	-	3,429 lm	650 mA	32.6 V	35.2 V	-	-	155 lm/W	>80
DLE G4 65mm 3000lm 840 R ADV	89602873	840/359	-	3,589 lm	650 mA	32.6 V	35.2 V	-	-	163 lm/W	>80
DLE G4 65mm 3000lm – Module without housing – Operating mode HO2											
DLE G4 65mm 3000lm 830 R ADV	89602872	830/359	-	4,816 lm	950 mA	33.7 V	36.2 V	-	-	146 lm/W	>80
DLE G4 65mm 3000lm 840 R ADV	89602873	840/359	-	5,030 lm	950 mA	33.7 V	36.2 V	-	-	153 lm/W	>80
DLE G4 65mm 3000lm – Module without housing – Operating mode HO3											
DLE G4 65mm 3000lm 830 R ADV	89602872	830/359	-	5,881 lm	1,200 mA	34.3 V	37.0 V	-	-	138 lm/W	>80
DLE G4 65mm 3000lm 840 R ADV	89602873	840/359	-	6,143 lm	1,200 mA	34.4 V	37.0 V	-	-	145 lm/W	>80
DLE G4 65mm 2000lm – Module with housing – Operating mode HE											
DLE G4 65mm 2000lm 830 H ADV	89602874	830/359	-	1,002 lm	400 mA	21.2 V	22.9 V	-	-	113 lm/W	>80
DLE G4 65mm 2000lm 840 H ADV	89602875	840/359	-	920 lm	350 mA	21.1 V	22.8 V	-	-	119 lm/W	>80
DLE G4 65mm 2000lm – Module with housing – Operating mode NM											
DLE G4 65mm 2000lm 830 H ADV	89602874	830/359	1,341 lm	1,245 lm	500 mA	21.5 V	23.2 V	11.5 W	117 lm/W	111 lm/W	>80
DLE G4 65mm 2000lm 840 H ADV	89602875	840/359	1,407 lm	1,303 lm	500 mA	21.5 V	23.2 V	11.5 W	122 lm/W	115 lm/W	>80
DLE G4 65mm 2000lm – Module with housing – Operating mode HO											
DLE G4 65mm 2000lm 830 H ADV	89602874	830/359	-	1,697 lm	700 mA	22.1 V	23.8 V	-	-	105 lm/W	>80
DLE G4 65mm 2000lm 840 H ADV	89602875	840/359	-	1,655 lm	650 mA	21.9 V	23.7 V	-	-	111 lm/W	>80
DLE G4 65mm 3000lm – Module with housing – Operating mode HE											
DLE G4 65mm 3000lm 830 H ADV	89602876	830/359	-	1,713 lm	450 mA	31.9 V	34.4 V	-	-	115 lm/W	>80
DLE G4 65mm 3000lm 840 H ADV	89602877	840/359	-	1,777 lm	450 mA	31.9 V	34.4 V	-	-	119 lm/W	>80
DLE G4 65mm 3000lm – Module with housing – Operating mode NM											
DLE G4 65mm 3000lm 830 H ADV	89602876	830/359	2,251 lm	2,080 lm	550 mA	32.2 V	34.8 V	18.9 W	119 lm/W	112 lm/W	>80
DLE G4 65mm 3000lm 840 H ADV	89602877	840/359	2,329 lm	2,153 lm	550 mA	32.2 V	34.8 V	18.9 W	123 lm/W	117 lm/W	>80
DLE G4 65mm 3000lm – Module with housing – Operating mode HO											
DLE G4 65mm 3000lm 830 H ADV	89602876	830/359	-	2,430 lm	650 mA	32.6 V	35.2 V	-	-	110 lm/W	>80
DLE G4 65mm 3000lm 840 H ADV	89602877	840/359	-	2,521 lm	650 mA	32.6 V	35.2 V	-	-	114 lm/W	>80
DLE G4 65mm 5000lm – Module with housing – Operating mode HE											
DLE G4 65mm 5000lm 830 H ADV	89603014	830/359	-	2,033 lm	550 mA	32.2 V	34.8 V	-	-	108 lm/W	>80
DLE G4 65mm 5000lm 840 H ADV	89603015	840/359	-	2,126 lm	550 mA	32.2 V	34.8 V	-	-	114 lm/W	>80
DLE G4 65mm 5000lm – Module with housing – Operating mode NM											
DLE G4 65mm 5000lm 830 H ADV	89603014	830/359	2,894 lm	2,687 lm	750 mA	33.0 V	35.5 V	26.4 W	110 lm/W	103 lm/W	>80
DLE G4 65mm 5000lm 840 H ADV	89603015	840/359	3,027 lm	2,806 lm	750 mA	33.0 V	35.5 V	26.4 W	115 lm/W	108 lm/W	>80
DLE G4 65mm 5000lm – Module with housing – Operating mode HO											
DLE G4 65mm 5000lm 830 H ADV	89603014	830/359	-	4,027 lm	1,200 mA	34.4 V	37.0 V	-	-	94 lm/W	>80
DLE G4 65mm 5000lm 840 H ADV	89603015	840/359	-	4,213 lm	1,200 mA	34.4 V	37.0 V	-	-	98 lm/W	>80

① Measured at operating mode HO.

② Tolerance of useful light flux - 0 % / + 15 %. Measurement uncertainty ± 10 %.

③ Tolerance of expected light flux - 0 % / + 15 %. Measurement uncertainty ± 10 %. Based on calculation.

④ Tolerance of power consumption Pon ± 10 %. Measurement uncertainty ± 5 %.

DLE GEN2 Adapter

Accessory

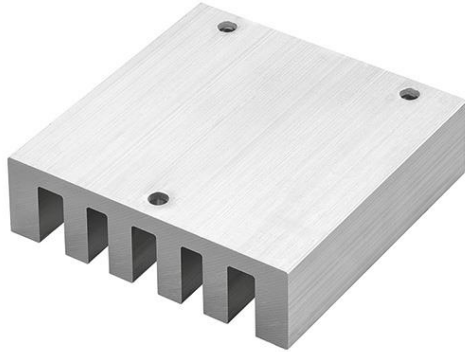

Product description

_ The adapter plate does not replace a heat sink

Website

<http://www.tridonic.com/28000420>

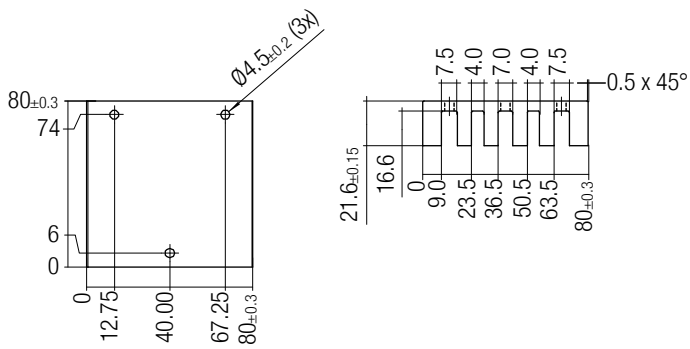

Ordering data

Type	Article number	Packaging, carton	Weight per pc.
DLE G2 Adapter	28000420	1 pc(s).	0.25 kg

1. Standards

IEC 62031
IEC 62471
IEC 62778
IEC 61547

1.1 Glow wire test

according to EN 62031 with increased temperature of 650 °C passed.

1.2 Photometric code

Key for photometric code, e. g. 830 / 359

1 st digit	2 nd + 3 rd digit	4 th digit	5 th digit	6 th digit	
Code	CRI	Colour temperature in Kelvin x 100	MacAdam initial	MacAdam after 25% of the lifetime (max.6000h)	
7	70 – 79			Code	Luminous flux
8	80 – 89			7	≥ 70 %
9	≥90			8	≥ 80 %
				9	≥ 90 %

1.3 Energy classification

Type	Colour temperature	Forward current	Energy classification	Energy consumption
DLE G4 65mm 2000lm – Without housing				
DLE G4 65mm 2000lm 830 R ADV	3,000 K	500 mA	D	12 kWh / 1,000 h
DLE G4 65mm 2000lm 840 R ADV	4,000 K	500 mA	C	12 kWh / 1,000 h
DLE G4 65mm 3000lm – Without housing				
DLE G4 65mm 3000lm 830 R ADV	3,000 K	550 mA	D	19 kWh / 1,000 h
DLE G4 65mm 3000lm 840 R ADV	4,000 K	550 mA	C	19 kWh / 1,000 h
DLE G4 65mm 2000lm – With housing				
DLE G4 65mm 2000lm 830 H ADV	3,000 K	500 mA	E	12 kWh / 1,000 h
DLE G4 65mm 2000lm 840 H ADV	4,000 K	500 mA	E	12 kWh / 1,000 h
DLE G4 65mm 3000lm – With housing				
DLE G4 65mm 3000lm 830 H ADV	3,000 K	550 mA	E	19 kWh / 1,000 h
DLE G4 65mm 3000lm 840 H ADV	4,000 K	550 mA	E	19 kWh / 1,000 h
DLE G4 65mm 5000lm – With housing				
DLE G4 65mm 5000lm 830 H ADV	3,000 K	750 mA	E	27 kWh / 1,000 h
DLE G4 65mm 5000lm 840 H ADV	4,000 K	750 mA	E	27 kWh / 1,000 h

Energy label and further information at www.tridonic.com in the certificates tab of the corresponding product page and at the EPREL data base <https://eprel.ec.europa.eu/>

2. Thermal details

2.1 tp point, ambient temperature and lifetime

The temperature at tp reference point is crucial for the light output and lifetime of a LED product.

For DLE G4 a tp temperature of 65 °C has to be complied in order to achieve an optimum between heat sink requirements, light output and lifetime.

Compliance with the maximum permissible reference temperature at the tp point must be checked under operating conditions in a thermally stable state. The maximum value must be determined under worst-case conditions for the relevant application.

To check the tc / tp temperature, the temperature sensor has to be mounted on the PCB at the marked position as stated in the drawing.

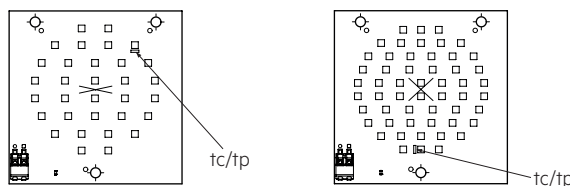

2.2 Storage and humidity

storage temperature	-30 ... +80 °C
---------------------	----------------

Operation only in non condensing environment.
Humidity during processing of the module should be between 30 to 70 %.

2.3 Derating curves

DLE G4 65mm 2000lm 8x0 R ADV

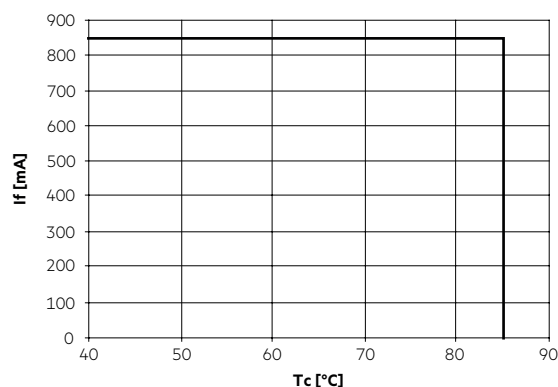

DLE G4 65mm 3000lm 8x0 R ADV

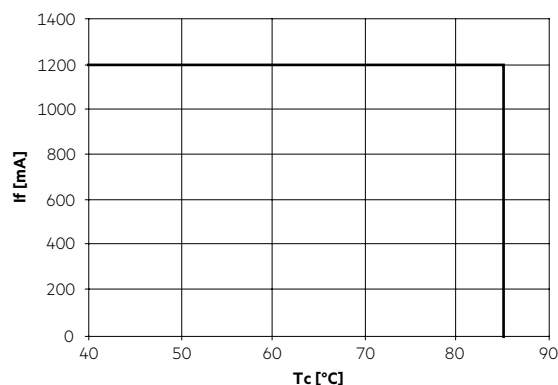

DLE G4 65mm 2000lm 830 H ADV (with housing)

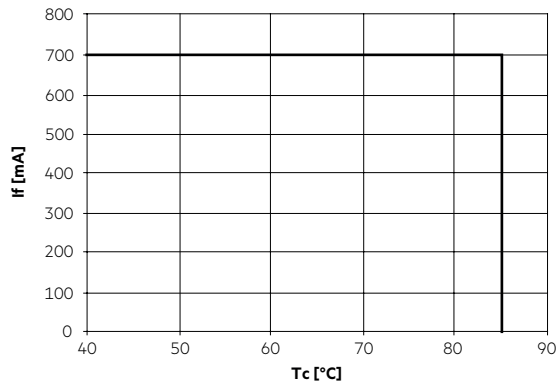

DLE G4 65mm 2000lm 840 H ADV (with housing)

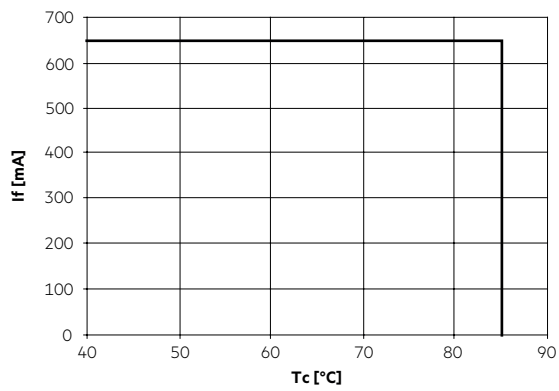

DLE G4 65mm 3000lm 8x0 H ADV (with housing)

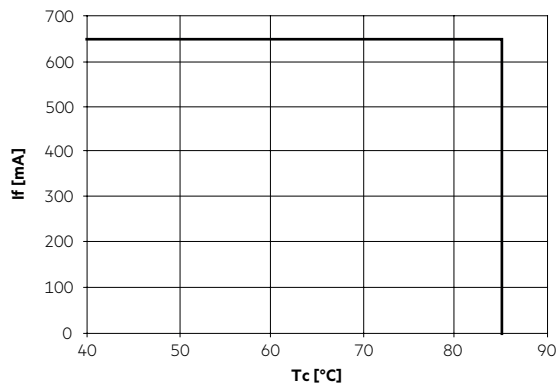

DLE G4 65mm 5000lm 8x0 H ADV (with housing)

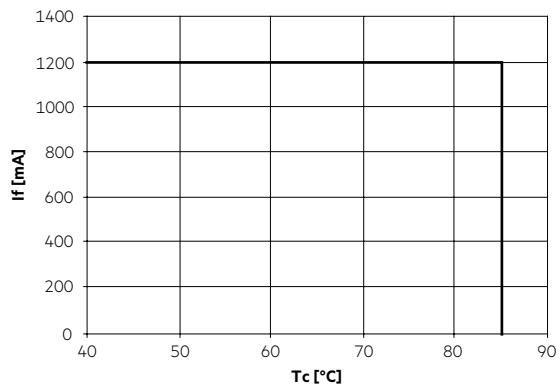

2.4 Thermal design and heat sink

The rated life of LED products depends to a large extent on the temperature. If the permissible temperature limits are exceeded, the life of the DLE G4 will be greatly reduced or the DLE G4 may be destroyed.

2.5 Heat sink values

DLE G4 65mm 2000lm 830 advanced

ta	tp	Forward current	R _{th, hs-a}
25°C	65°C	400 mA	8.00 K/W
35°C	65°C	400 mA	6.00 K/W
45°C	65°C	400 mA	4.00 K/W
55°C	65°C	400 mA	2.00 K/W
25°C	65°C	500 mA	6.54 K/W
35°C	65°C	500 mA	4.90 K/W
45°C	65°C	500 mA	3.27 K/W
55°C	65°C	500 mA	1.63 K/W
25°C	65°C	700 mA	4.32 K/W
35°C	65°C	700 mA	3.24 K/W
45°C	65°C	700 mA	2.16 K/W
55°C	65°C	700 mA	1.08 K/W

DLE G4 65mm 2000lm 840 advanced

ta	tp	Forward current	R _{th, hs-a}
25°C	65°C	350 mA	10.46 K/W
35°C	65°C	350 mA	7.84 K/W
45°C	65°C	350 mA	5.23 K/W
55°C	65°C	350 mA	2.61 K/W
25°C	65°C	500 mA	6.79 K/W
35°C	65°C	500 mA	5.09 K/W
45°C	65°C	500 mA	3.39 K/W
55°C	65°C	500 mA	1.69 K/W
25°C	65°C	650 mA	4.68 K/W
35°C	65°C	650 mA	3.51 K/W
45°C	65°C	650 mA	2.34 K/W
55°C	65°C	650 mA	1.17 K/W

DLE G4 65mm 3000lm 830 advanced

ta	tp	Forward current	R _{th, hs-a}
25°C	65°C	450 mA	5.06 K/W
35°C	65°C	450 mA	3.79 K/W
45°C	65°C	450 mA	2.53 K/W
55°C	65°C	450 mA	1.26 K/W
25°C	65°C	550 mA	3.92 K/W
35°C	65°C	550 mA	2.94 K/W
45°C	65°C	550 mA	1.96 K/W
55°C	65°C	550 mA	0.98 K/W
25°C	65°C	650 mA	3.25 K/W
35°C	65°C	650 mA	2.43 K/W
45°C	65°C	650 mA	1.62 K/W
55°C	65°C	650 mA	0.81 K/W
25°C	65°C	1,200 mA	1.52 K/W
35°C	65°C	1,200 mA	1.15 K/W
45°C	65°C	1,200 mA	0.77 K/W
55°C	65°C	1,200 mA	0.38 K/W

DLE G4 65mm 3000lm 840 advanced

ta	tp	Forward current	R _{th, hs-a}
25°C	65°C	450 mA	5.24 K/W
35°C	65°C	450 mA	3.93 K/W
45°C	65°C	450 mA	2.62 K/W
55°C	65°C	450 mA	1.31 K/W
25°C	65°C	550 mA	4.18 K/W
35°C	65°C	550 mA	3.13 K/W
45°C	65°C	550 mA	2.09 K/W
55°C	65°C	550 mA	1.04 K/W
25°C	65°C	650 mA	3.36 K/W
35°C	65°C	650 mA	2.52 K/W
45°C	65°C	650 mA	1.68 K/W
55°C	65°C	650 mA	0.84 K/W
25°C	65°C	1,200 mA	1.61 K/W
35°C	65°C	1,200 mA	1.19 K/W
45°C	65°C	1,200 mA	0.78 K/W
55°C	65°C	1,200 mA	0.41 K/W

DLE G4 65mm 5000lm 830 advanced

ta	tp	Forward current	R _{th, hs-a}
25°C	65°C	550 mA	3.92 K/W
35°C	65°C	550 mA	2.94 K/W
45°C	65°C	550 mA	1.96 K/W
55°C	65°C	550 mA	0.98 K/W
25°C	65°C	750 mA	2.69 K/W
35°C	65°C	750 mA	2.50 K/W
45°C	65°C	750 mA	1.35 K/W
55°C	65°C	750 mA	0.67 K/W
25°C	65°C	950 mA	2.05 K/W
35°C	65°C	950 mA	1.54 K/W
45°C	65°C	950 mA	1.00 K/W
55°C	65°C	950 mA	0.50 K/W
25°C	65°C	1,200 mA	1.52 K/W
35°C	65°C	1,200 mA	1.15 K/W
45°C	65°C	1,200 mA	0.77 K/W
55°C	65°C	1,200 mA	0.38 K/W

DLE G4 65mm 5000lm 840 advanced

ta	tp	Forward current	R _{th, hs-a}
25°C	65°C	550 mA	4.18 K/W
35°C	65°C	550 mA	3.13 K/W
45°C	65°C	550 mA	2.09 K/W
55°C	65°C	550 mA	1.04 K/W
25°C	65°C	750 mA	2.82 K/W
35°C	65°C	750 mA	2.10 K/W
45°C	65°C	750 mA	1.41 K/W
55°C	65°C	750 mA	0.71 K/W
25°C	65°C	950 mA	2.13 K/W
35°C	65°C	950 mA	1.59 K/W
45°C	65°C	950 mA	1.06 K/W
55°C	65°C	950 mA	0.53 K/W
25°C	65°C	1,200 mA	1.61 K/W
35°C	65°C	1,200 mA	1.19 K/W
45°C	65°C	1,200 mA	0.78 K/W
55°C	65°C	1,200 mA	0.41 K/W

Notes

The actual cooling can differ because of the material, the structural shape, outside influences and the installation situation. A thermal connection between DLE G4 and heat sink with heat-conducting paste or heat conducting adhesive film is absolutely necessary.

Additionally the DLE G4 has to be fixed on the heat sink with M3 screws to optimise the thermal connection.

Use of thermal interface material with thermal conductivity of $\lambda > 1 \text{ W/mK}$ and layer thickness of interface material with max. 50 μm or a similar interface material where the quotient of layer thickness and thermal conductivity $b < 50 \text{ } \mu\text{mmK/W}$.

3. Installation / wiring

3.1 Electrical supply/choice of LED driver

DLE G4 from Tridonic are not protected against overvoltages, overcurrents, overloads or short-circuit currents. Safe and reliable operation can only be guaranteed in conjunction with a LED driver which complies with the relevant standards. The use of LED drivers from Tridonic in combination with DLE G4 guarantees the necessary protection for safe and reliable operation.

If a LED driver other than Tridonic is used, it must provide the following protection:

- Short-circuit protection
- Overload protection
- Overtemperature protection



DLE G4 must be supplied by a constant current LED driver. Operation with a constant voltage LED driver will lead to an irreversible damage of the module. Wrong polarity can damage the DLE G4.



DLE G4 are basic insulated up to 60 V SELV against ground and can be mounted directly on earthed metal parts of the luminaire. If the max. output voltage of the LED driver (also against earth) is above 60 V SELV, an additional insulation between LED module and heat sink is required (for example by insulated thermal pads) or by a suitable luminaire construction. At voltages > 60 V an additional protection against direct touch (test finger) to the light emitting side of the module has to be guaranteed. This is typically achieved by means of a non removable light distributor over the module.

3.3 Wiring

Wiring with housing

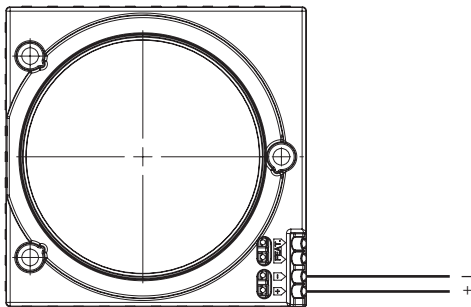

Wiring without housing

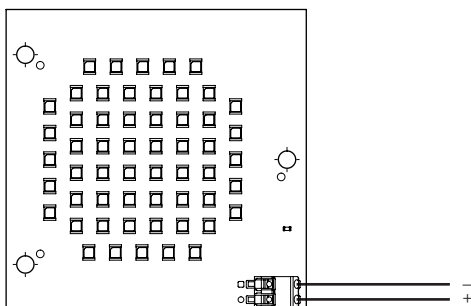

Wiring example

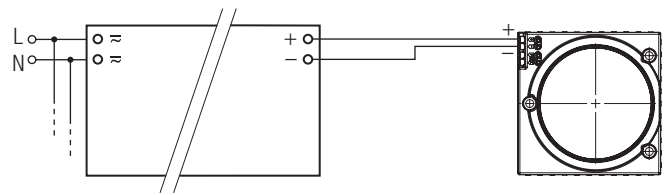

TALEXdriver LC...

3.4 Wiring type and cross section

For wiring use stranded wire with ferrules or solid wire from 0.2 to 0.75 mm². For the push-wire connection you have to strip the insulation (7–9 mm). Loosen wire through twisting and pulling.

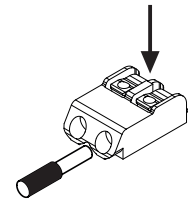
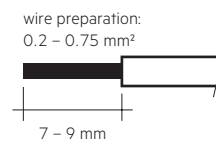

Release of the wiring

Press down the “push button” and remove the cable from front.

3.4 Mounting instruction



DLE G4 from Tridonic which have to be installed on a heat sink have to be connected with heat-conducting paste or heat conducting adhesive film and fixed with M3 screws. The fixing/cooling surface must be cleaned by removing all dirt, dust and grease before installing the LED modules.

None of the components of the DLE G4 (substrate, LED, electronic components etc.) may be exposed to tensile or compressive stresses.



Max. torque for fixing: 0.5 Nm.

The LED modules are mounted with 3 screws per module. In order not to damage the modules only rounded head screws and an additional plastic flat washer should be used for LED modules without housing.

For further information please refer to the brochure entitled “Technical Design-In-Guide DLE G4”.



Chemical substance may harm the LED module. Chemical reactions could lead to colour shift, reduced luminous flux or a total failure of the module caused by corrosion of electrical connections.

Materials which are used in LED applications (e.g. sealings, adhesives) must not produce dissolver gas. They must not be condensation curing based, acetate curing based or contain sulfur, chlorine or phthalate. Avoid corrosive atmosphere during usage and storage.

3.6 EOS/ESD safety guidelines



The device / module contains components that are sensitive to electrostatic discharge and may only be installed in the factory and on site if appropriate EOS/ESD protection measures have been taken. No special measures need be taken for devices/modules with enclosed casings (contact with the pc board not possible), just normal installation practice.

For further information for EOS/ESD safety guidelines and the ESD classification please refer to the brochure entitled <http://www.tridonic.com/esd-protection>.

4. Lifetime

4.1 Lifetime, lumen maintenance and failure rate

The light output of an LED module decreases over the lifetime, this is characterized with the L value. L70 means that the LED module will give 70 % of its initial luminous flux. This value is always related to the number of operation hours and therefore defines the lifetime of an LED module.

As the L value is a statistical value and the lumen maintenance may vary over the delivered LED modules. The B value defines the amount of modules which are below the specific L value, e.g. L70B10 means 10 % of the LED modules are below 70 % of the initial luminous flux, respectively 90 % will be above 70 % of the initial value.

In addition the percentage of failed modules (fatal failure) is characterized by the C value.

The F value is the combination of the B and C value. That means for F degradation and complete failures are considered, e.g. L70F10 means 10 % of the LED modules may fail or be below 70 % of the initial luminous flux.

4.2 Lumen maintenance

DLE G4 65mm 2000lm 8x0 advanced

Operating current	tp temperature	L90 / F10	L90 / F50	L80 / F10	L80 / F50	L70 / F10	L70 / F50
350 mA	55 °C	>50,000 h	>50,000 h	>50,000 h	>50,000 h	>50,000 h	>50,000 h
	65 °C	>50,000 h	>50,000 h	>50,000 h	>50,000 h	>50,000 h	>50,000 h
	75 °C	>50,000 h	>50,000 h	>50,000 h	>50,000 h	>50,000 h	>50,000 h
	85 °C	>50,000 h	>50,000 h	>50,000 h	>50,000 h	>50,000 h	>50,000 h
450 mA	55 °C	>50,000 h	>50,000 h	>50,000 h	>50,000 h	>50,000 h	>50,000 h
	65 °C	>50,000 h	>50,000 h	>50,000 h	>50,000 h	>50,000 h	>50,000 h
	75 °C	>50,000 h	>50,000 h	>50,000 h	>50,000 h	>50,000 h	>50,000 h
	85 °C	>50,000 h	>50,000 h	>50,000 h	>50,000 h	>50,000 h	>50,000 h
500 mA	55 °C	40,000 h	50,000 h	>50,000 h	>50,000 h	>50,000 h	>50,000 h
	65 °C	40,000 h	50,000 h	>50,000 h	>50,000 h	>50,000 h	>50,000 h
	75 °C	40,000 h	50,000 h	>50,000 h	>50,000 h	>50,000 h	>50,000 h
	85 °C	40,000 h	50,000 h	>50,000 h	>50,000 h	>50,000 h	>50,000 h
650 mA	55 °C	40,000 h	50,000 h	>50,000 h	>50,000 h	>50,000 h	>50,000 h
	65 °C	40,000 h	50,000 h	>50,000 h	>50,000 h	>50,000 h	>50,000 h
	75 °C	40,000 h	50,000 h	>50,000 h	>50,000 h	>50,000 h	>50,000 h
	85 °C	40,000 h	50,000 h	>50,000 h	>50,000 h	>50,000 h	>50,000 h
700 mA	55 °C	40,000 h	50,000 h	>50,000 h	>50,000 h	>50,000 h	>50,000 h
	65 °C	40,000 h	50,000 h	>50,000 h	>50,000 h	>50,000 h	>50,000 h
	75 °C	40,000 h	50,000 h	>50,000 h	>50,000 h	>50,000 h	>50,000 h
	85 °C	40,000 h	50,000 h	>50,000 h	>50,000 h	>50,000 h	>50,000 h

DLE G4 65mm 3000lm 8x0 advanced

Operating current	tp temperature	L90 / F10	L90 / F50	L80 / F10	L80 / F50	L70 / F10	L70 / F50
450 mA	55 °C	>50,000 h	>50,000 h	>50,000 h	>50,000 h	>50,000 h	>50,000 h
	65 °C	>50,000 h	>50,000 h	>50,000 h	>50,000 h	>50,000 h	>50,000 h
	75 °C	>50,000 h	>50,000 h	>50,000 h	>50,000 h	>50,000 h	>50,000 h
	85 °C	>50,000 h	>50,000 h	>50,000 h	>50,000 h	>50,000 h	>50,000 h
550 mA	55 °C	40,000 h	50,000 h	>50,000 h	>50,000 h	>50,000 h	>50,000 h
	65 °C	40,000 h	50,000 h	>50,000 h	>50,000 h	>50,000 h	>50,000 h
	75 °C	40,000 h	50,000 h	>50,000 h	>50,000 h	>50,000 h	>50,000 h
	85 °C	40,000 h	50,000 h	>50,000 h	>50,000 h	>50,000 h	>50,000 h
650 mA	55 °C	40,000 h	50,000 h	>50,000 h	>50,000 h	>50,000 h	>50,000 h
	65 °C	40,000 h	50,000 h	>50,000 h	>50,000 h	>50,000 h	>50,000 h
	75 °C	40,000 h	50,000 h	>50,000 h	>50,000 h	>50,000 h	>50,000 h
	85 °C	40,000 h	50,000 h	>50,000 h	>50,000 h	>50,000 h	>50,000 h
950 mA	55 °C	33,000 h	40,000 h	>50,000 h	>50,000 h	>50,000 h	>50,000 h
	65 °C	33,000 h	40,000 h	>50,000 h	>50,000 h	>50,000 h	>50,000 h
	75 °C	33,000 h	40,000 h	>50,000 h	>50,000 h	>50,000 h	>50,000 h
	85 °C	33,000 h	40,000 h	>50,000 h	>50,000 h	>50,000 h	>50,000 h
1,200 mA	55 °C	26,000 h	33,000 h	>50,000 h	>50,000 h	>50,000 h	>50,000 h
	65 °C	26,000 h	33,000 h	>50,000 h	>50,000 h	>50,000 h	>50,000 h
	75 °C	26,000 h	33,000 h	>50,000 h	>50,000 h	>50,000 h	>50,000 h
	85 °C	26,000 h	33,000 h	>50,000 h	>50,000 h	>50,000 h	>50,000 h

DLE G4 65mm 5000lm 8x0 advanced

Operating current	tp temperature	L90 / F10	L90 / F50	L80 / F10	L80 / F50	L70 / F10	L70 / F50
550 mA	55 °C	40,000 h	50,000 h	>50,000 h	>50,000 h	>50,000 h	>50,000 h
	65 °C	40,000 h	50,000 h	>50,000 h	>50,000 h	>50,000 h	>50,000 h
	75 °C	40,000 h	50,000 h	>50,000 h	>50,000 h	>50,000 h	>50,000 h
	85 °C	40,000 h	50,000 h	>50,000 h	>50,000 h	>50,000 h	>50,000 h
750 mA	55 °C	50,000 h	40,000 h	>50,000 h	>50,000 h	>50,000 h	>50,000 h
	65 °C	50,000 h	40,000 h	>50,000 h	>50,000 h	>50,000 h	>50,000 h
	75 °C	50,000 h	40,000 h	>50,000 h	>50,000 h	>50,000 h	>50,000 h
	85 °C	50,000 h	40,000 h	>50,000 h	>50,000 h	>50,000 h	>50,000 h
950 mA	55 °C	33,000 h	40,000 h	>50,000 h	>50,000 h	>50,000 h	>50,000 h
	65 °C	33,000 h	40,000 h	>50,000 h	>50,000 h	>50,000 h	>50,000 h
	75 °C	33,000 h	40,000 h	>50,000 h	>50,000 h	>50,000 h	>50,000 h
	85 °C	33,000 h	40,000 h	>50,000 h	>50,000 h	>50,000 h	>50,000 h
1,200 mA	55 °C	26,000 h	33,000 h	>50,000 h	>50,000 h	>50,000 h	>50,000 h
	65 °C	26,000 h	33,000 h	>50,000 h	>50,000 h	>50,000 h	>50,000 h
	75 °C	26,000 h	33,000 h	>50,000 h	>50,000 h	>50,000 h	>50,000 h
	85 °C	26,000 h	33,000 h	>50,000 h	>50,000 h	>50,000 h	>50,000 h

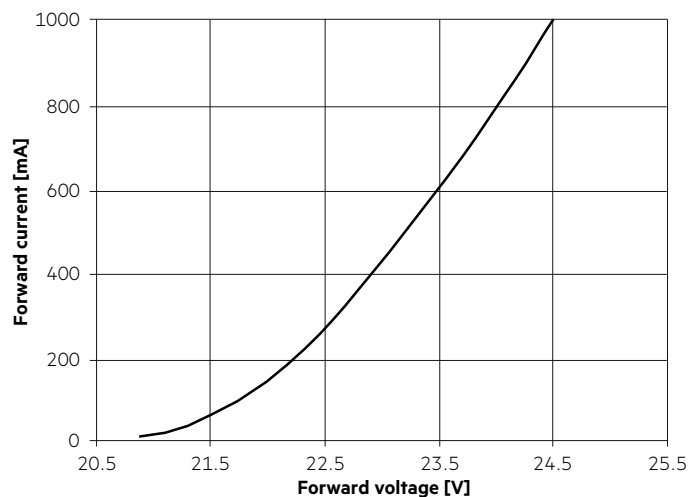
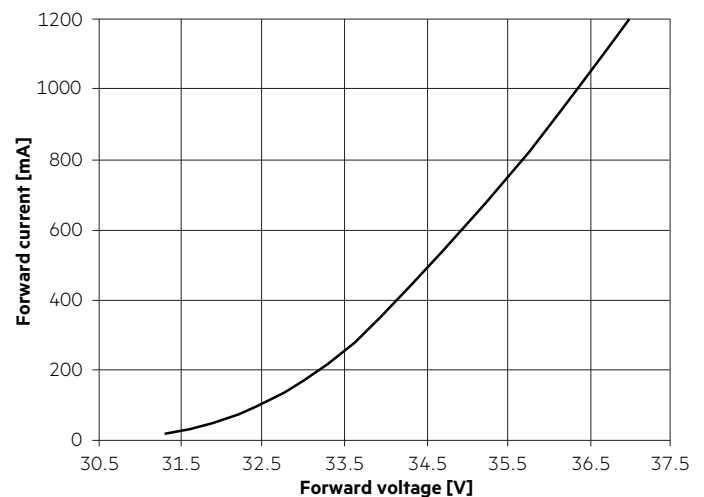
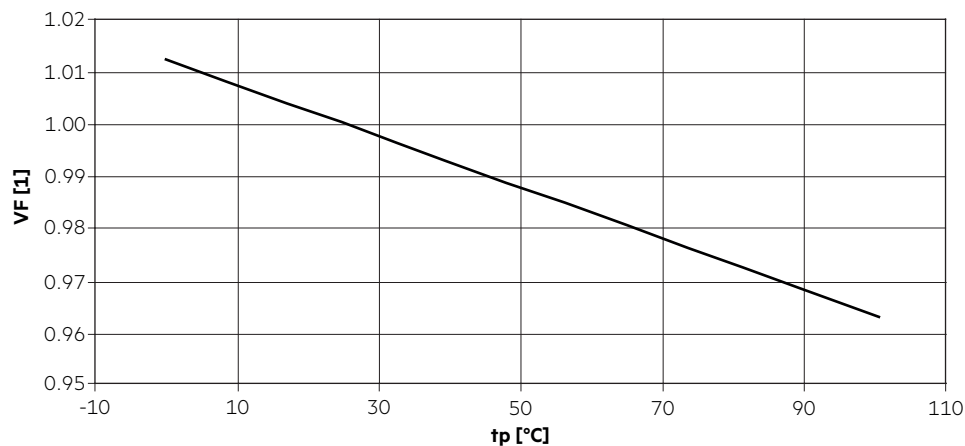
5. Electrical values**5.1 Typ. forward voltage vs. forward current at tp = 65 °C****DLE G4 65mm 2000lm 8x0 advanced****DLE G4 65mm 3000lm / 5000lm 8x0 advanced****5.2 Forward voltage vs. tp temperature**

The diagrams based on statistic values.
The real values can be different.

6. Photometric characteristics

6.1 Coordinates and tolerances according to CIE 1931

The specified colour coordinates are measured integral after a settling time of 100 ms. The current impuls depends on the module type.

Module type	Current impulse
DLE G4 65mm 2000lm 8x0 ADV	500 mA
DLE G4 65mm 3000lm 8x0 ADV	550 mA
DLE G4 65mm 5000lm 8x0 ADV	550 mA

The ambient temperature of the measurement is $t_a = 25\text{ }^\circ\text{C}$.
The measurement tolerance of the colour coordinates are ± 0.01 .

6.2 Colour coordinates for LED module without housing

3,000 K

	x0	y0
Centre	0.4362	0.4025

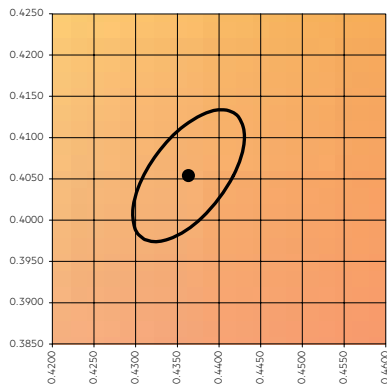

MacAdam ellipse: 3SDCM

	x	y
Colour shift DLE G4 R to DLE G4 H for 2,000 lm	+0.0015	+0.0005
Colour shift DLE G4 R to DLE G4 H for 3,000 lm	+0.0030	+0.0010
Colour shift DLE G4 R 3,000 lm to DLE G4 H for 5,000 lm	+0.0004	+0.0006

4,000 K

	x0	y0
Centre	0.3825	0.3796

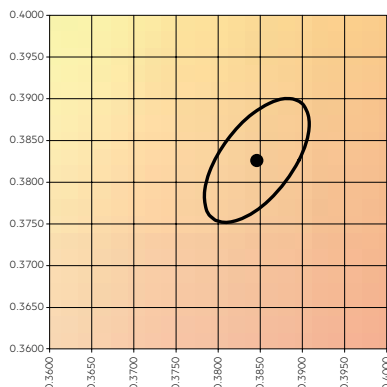

MacAdam ellipse: 3SDCM

	x	y
Colour shift DLE G4 R to DLE G4 H for 2,000 lm	+0.0016	+0.0017
Colour shift DLE G4 R to DLE G4 H for 3,000 lm	+0.0033	+0.0028
Colour shift DLE G4 R 3,000 lm to DLE G4 H for 5,000 lm	+0.0004	+0.0018

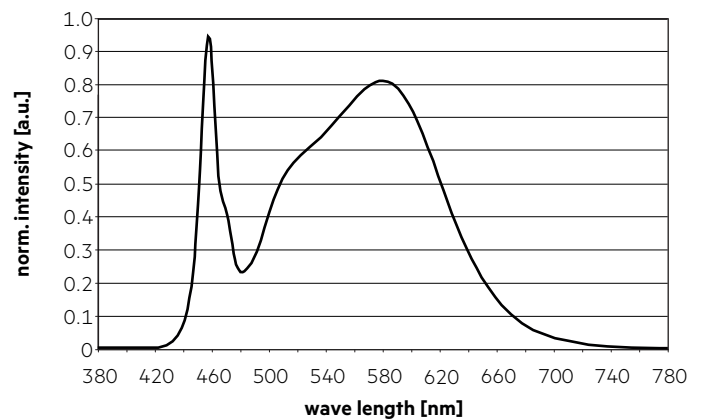
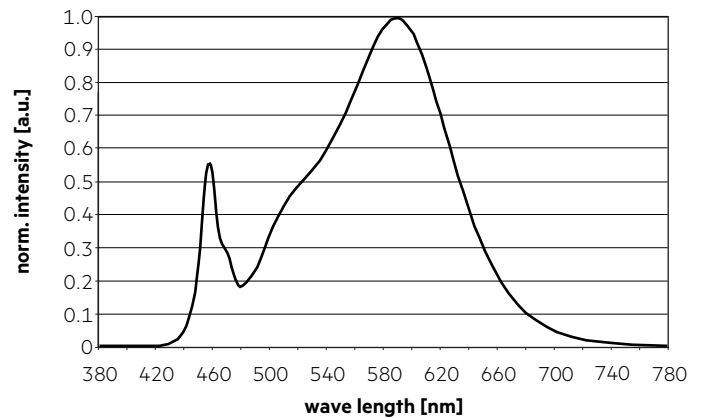

6.3 Light distribution

The optical design of the DLE product line ensures optimum homogeneity for the light distribution.

Light distribution without housing (only LED module)

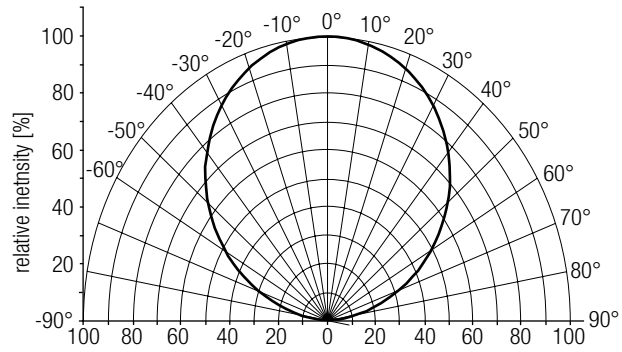

Light distribution with housing

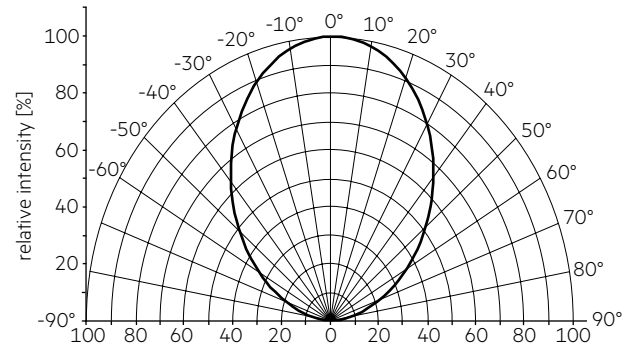

6.4 Relative luminous flux vs. tp temperature

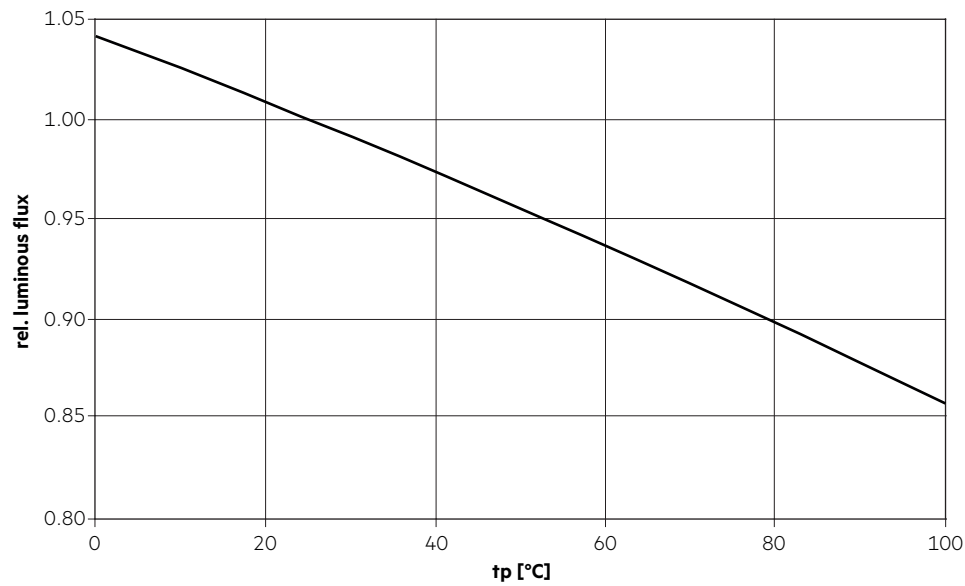

6.5 Relative luminous flux vs. operating current at $t_p = 65\text{ }^\circ\text{C}$

DLE G4 65mm 2000lm 8x0 R advanced

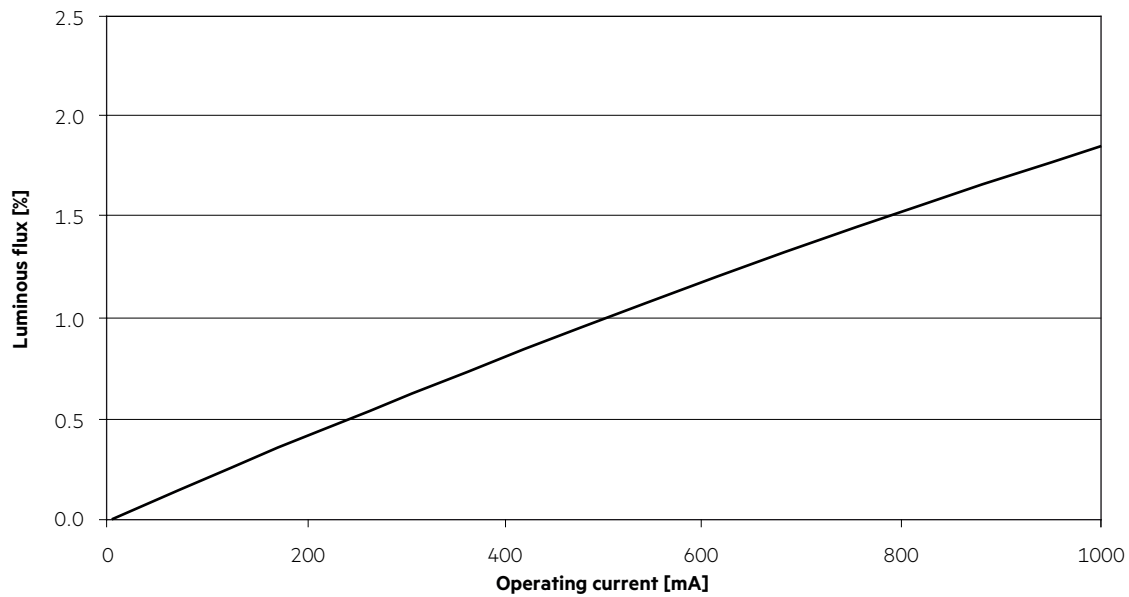

DLE G4 65mm 3000lm 8x0 advanced

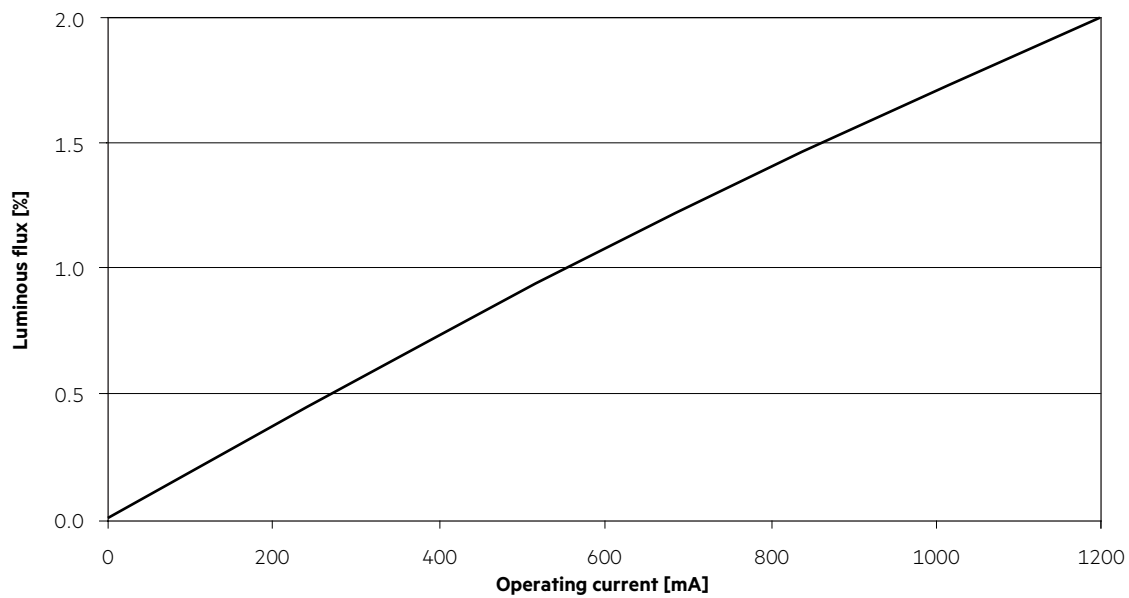

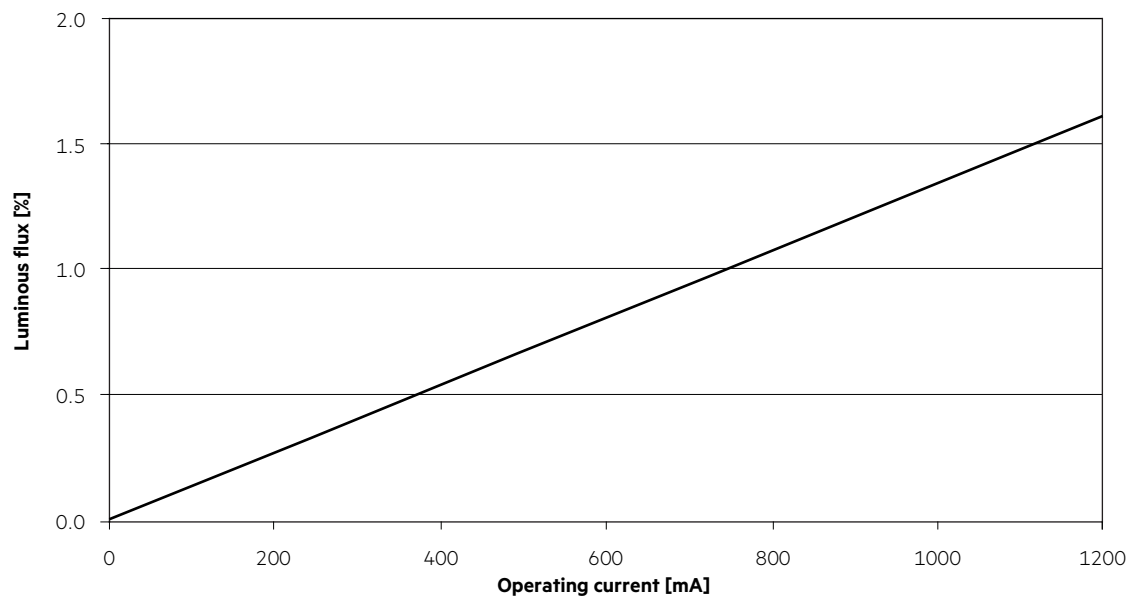
DLE G4 65mm 5000lm 8x0 H advanced**7. Miscellaneous****7.1 Additional information**

Additional technical information at www.tridonic.com → Technical Data

Guarantee conditions at www.tridonic.com → Services

Lifetime declarations are informative and represent no warranty claim.