

**EM powerLED SELFTEST 4 W**

Combined emergency lighting LED driver 1 – 4 W

**Product description**

- \_ Emergency lighting LED driver with selftest function
- \_ For self-contained emergency lighting
- \_ SELV for output voltage < 60 V DC
- \_ Low profile casing (21 x 30 mm cross-section)
- \_ EM = Emergency
- \_ 5 years guarantee (conditions at <https://www.tridonic.com/en/int/services/manufacturer-guarantee-conditions>)

**Properties**

- \_ Non maintained operation
- \_ Self-test as per IEC 62034
- \_ Constant current mode
- \_ With either screw or clip fastening (clip-fix)
- \_ 1, 2 or 3 h rated duration
- \_ Selectable operating time (jumper)
- \_ Output power limitation
- \_ Two-colour status display LED
- \_ "Rest mode" function
- \_ Simple set-up
- \_ Automatic restart after LED replacement
- \_ Electronic multi-level charge system
- \_ SELV classified (outputs powerLED, battery, status LED, test switch)
- \_ Polarity reversal protection for battery
- \_ Deep discharge protection
- \_ Very low energy consumption from the battery after activation of the deep discharge protection
- \_ Short-circuit-proof battery connection
- \_ Emergency lighting LEDs available
- \_ Self-test:
  - \_ Status of the battery
  - \_ Status of the LED
  - \_ Charge condition
  - \_ Function test
  - \_ Duration test

**Batteries**

- \_ High-temperature cells
- \_ NiCd or NiMH batteries
- \_ 4 year design life
- \_ 2 years guarantee (conditions at <https://www.tridonic.com/en/int/services/manufacturer-guarantee-conditions>)
- \_ For battery compatibility refer to data sheet

**Website**

<http://www.tridonic.com/89800124>



**EM powerLED SELFTEST 4 W**

Combined emergency lighting LED driver 1 – 4 W

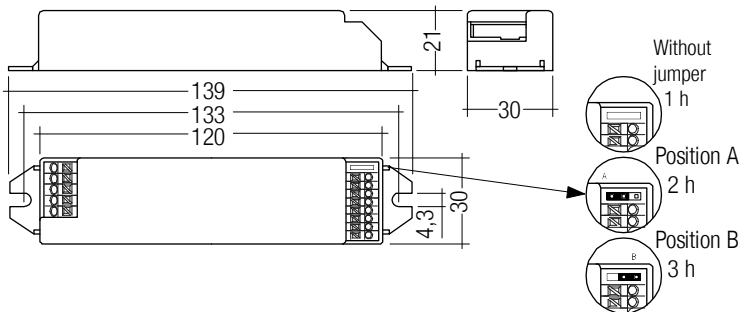

**Ordering data**

Type	Article number	Rated duration	Max. number of LEDs	Wattage	Packaging, carton	Packaging, pallet	Weight per pc.
<b>Screw fastening version</b>							
EM powerLED 4 W ST SCREW-FIX	89800124	1/2/3 h	2	4 W	25 pc(s).	1,200 pc(s).	0.068 kg
EM powerLED 4 W ST NIMH SCREW-FIX	89800445	1/2/3 h	2	4 W	25 pc(s).	1,200 pc(s).	0.068 kg

**Technical data**

Rated supply voltage	220 – 240 V
Mains frequency	50 / 60 Hz
Forward voltage range LED module (1 x LED)	2.8 – 3.4 V
Forward voltage range LED module (2 x LED)	5.6 – 6.8 V
Max. open circuit voltage	10 V
LED current in emergency operation (1 x LED)	1,000 mA
LED current in emergency operation (2 x LED)	700 mA
Typ. output power (1 x LED)	3.4 W
Typ. output power (2 x LED)	4.5 W
Starting time	0.23 s from detection of emergency event
Overvoltage protection	320 V (for 1 h)
Battery discharge current	Refer to data sheet
Max. casing temperature tc	70 °C
Ambient temperature ta	-25 ... +45 °C
Mains voltage changeover threshold	According to EN 60598-2-22
Type of protection	IP20
Rest mode max. number of emergency units	100
Rest mode max. wiring distance	1,000 m
Functional test	Weekly 5s test
Service life test	Yearly 1 h / 2 h / 3 h test
Lifetime	up to 50,000 h
Guarantee (conditions at www.tridonic.com)	5 Year(s)
Dimensions L x W x H	139 x 30 x 21 mm

**Approval marks**



**Standards**

according to EN 50172, according to EN 60598-2-22, EN 61347-2-7, EN 61347-2-13, EN 62384, EN 62034, EN 55015, EN 61000-3-2, EN 61000-3-3, EN 61547, EN 60068-2-29, EN 60068-2-30, EN 60068-2-64

## Specific technical data

Type	Rated duration	Typ. $\lambda$ (at 230 V, 50 Hz)	Mains current in charging operation			Mains power in charging operation		
			Initial charge	Fast recharge	Trickle charge <sup>①</sup>	Initial charge	Fast recharge	Trickle charge <sup>①</sup>
<b>EM powerLED 4 W ST SCREW-FIX</b>	1 h	0.34C	21.0 mA	27.5 mA	15.2 mA	2.0 W	3.0 W	1.2 W
<b>EM powerLED 4 W ST SCREW-FIX</b>	2 h	0.34C	27.5 mA	32.4 mA	21.0 mA	3.0 W	3.7 W	2.0 W
<b>EM powerLED 4 W ST SCREW-FIX</b>	3 h	0.34C	27.5 mA	32.4 mA	21.0 mA	3.0 W	3.7 W	2.0 W
<b>EM powerLED 4 W ST NiMH SCREW-FIX</b>	1 h	0.34C	19.0 mA	24.0 mA	13.0 mA	1.7 W	2.4 W	1.0 W
<b>EM powerLED 4 W ST NiMH SCREW-FIX</b>	2 h	0.34C	30.0 mA	32.0 mA	13.0 mA	3.1 W	3.3 W	1.1 W
<b>EM powerLED 4 W ST NiMH SCREW-FIX</b>	3 h	0.34C	30.0 mA	32.0 mA	13.0 mA	3.1 W	3.3 W	1.1 W

① For EM powerLED 4 W NiMH: average over 20 min. (4 min. charge / 16 min. off)

## Test switch EM2

Accessory



## Product description

- \_ For connection to the emergency lighting unit
- \_ For checking the device function
- \_ Dielectric strength: 1,500 V AC for 60 seconds
- \_ Lead length 0.55m
- \_ Mounting hole 7,0 mm diameter

## Website

<http://www.tridonic.com/89805277>



## Ordering data

Type	Article number	Packaging, bag	Packaging, carton	Weight per pc.
Test switch EM 2	89805277	25 pc(s).	1,800 pc(s).	0.009 kg

## Approval marks

RoHS

## Status indication bi-colour LED EM

Accessory



## Product description

- \_ Two-colour status display LED
- \_ Green: system OK, red: fault

## Website

<http://www.tridonic.com/89899720>



## Ordering data

Type	Article number	Packaging, bag	Packaging, carton	Weight per pc.
LED EM bi-colour	89899720	25 pc(s).	200 pc(s).	0.016 kg
LED EM bi-colour, high brightness	89899753	25 pc(s).	200 pc(s).	0.016 kg

## Approval marks

RoHS

EMpLED Strain-relief set 200x43x25.5mm

Accessory



**Product description**

- \_ Optional strain-relief for independent applications
- \_ Transforms the LED driver into a fully class II compatible LED driver (e.g. ceiling installation)
- \_ Easy and tool-free mounting to the LED driver, screwless cable-clamp channels with strain-relief (200 x 43 x 25.5 mm)

**Website**

<http://www.tridonic.com/28004033>



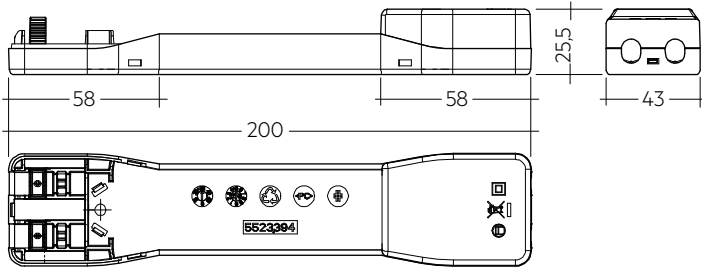

Permissible cable jacket diameter 2.2 – 9 mm

**Ordering data**

Type	Article number	Packaging, carton	Weight per pc.
EM pLED SR	28004033	10 pc(s).	0.05 kg

**Approval marks**



**Battery selection**

**EM powerLED 4W BASIC, 1 / 2 / 3 h**

		Type	EM powerLED 4W ST		EM powerLED 4W ST NiMH	
		Article no.	89800124		89800445	
		Cells	5 cells		5 cells	
		Duration	1 h	2 / 3 h	1 h	2 / 3 h
Technology and capacity	Design	Number of cells	Type	Article no.	Assignable batteries	
NiCd 4 Ah	stick	1 x 5	Accu-NiCd 5A 55	28002774	•	
D cells <sup>®</sup>	stick + stick	3 + 2	Accu-NiCd 5C 55	89800090	•	
NiMH 2,2 Ah	stick	1 x 5	Accu-NiMH 5A	28002090	•	•
Cs cells	side by side	5 x 1	Accu-NiMH 5B	28002093	•	•
NiMH 4 Ah LA cells	stick + stick	2 + 3	Accu-NiMH 4Ah 5C CON	89800439		•

**Battery charge / discharge data**

**EM powerLED 4W BASIC, 1 / 2 / 3 h**



		Type	EM powerLED 4W ST		EM powerLED 4W ST NiMH		
		Article no.	89800124		89800445		
		Cells	5 cells		5 cells		
		Duration	1 h	2 / 3 h	1 h	2 / 3 h	
Battery charge time	Initial charge	20 h					
	Fast recharge	10 h	15 h	10 h	15 h		
	Trickle charge	continuously					
Charge current	Initial charge	130 mA	250 mA	130 mA	300 mA		
	Fast recharge	250 mA	330 mA	210 mA	330 mA		
	Trickle charge	60 mA	130 mA	127 mA / 4 min. 0 mA / 16 min.	201 mA / 4 min. 0 mA / 16 min.		
Discharge current		1,100 mA	1,100 mA	1,100 mA	1,100 mA		
Charge voltage range <sup>®</sup>		1.07 – 1.6 V per cell					
Discharge voltage range		1.6 – 1.07 V per cell					

<sup>®</sup> The battery will be charged below 1.07 V. The EM powerLED will indicate a battery fault. The emergency lighting LED driver will recharge the battery normally after running the test of 61347-2-7 CL 22.3 (abnormal operating conditions).

**Standards**

- EN 61347-2-7
- EN 61347-2-13
- EN 62384
- EN 55015
- EN 61000-3-2
- EN 61000-3-3
- EN 61547
- EN 60068-2-64
- EN 60068-2-29
- EN 60068-2-30
- according to EN 50172
- according to EN 60598-2-22
- according to EN 62034

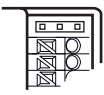
**Duration link selection**

Duration	Link Position
1 hr	 without jumper
2 hr	 position A
3 hr	 position B



### Rest Mode / Inhibit Mode

Emergency operation is automatically started when the mains supply is switched off. If the Rest Mode is activated, the discharging of the battery will be minimized by switching off the LED output. If the Inhibit Mode has been activated before the mains supply is switched off, Rest Mode will be automatically activated if the mains supply is switched off within 15 minutes. Rest Mode and Inhibit Mode can be initiated by applying a short pulse between 9.5 and 22.5 V<sub>DC</sub> in amplitude for a period of 150 to 1,000 ms. This pulse shall be applied to terminals marked Rest. After a mains reset the EM powerLED ST exits the Rest Mode. Rest Mode and Inhibit Mode can both be disabled by applying a voltage pulse of 1,000 to 2,000 ms to the terminals marked as Rest to send the RE-LIGHT/RESET INHIBIT command.

Pulse/Mode	Standby	Emergency	Rest
150 – 1,000 ms	Inhibit	Rest	–
1,000 – 2,000 ms	Cancel inhibit	–	Re-light

### Insulation and electric strength testing of luminaires

Electronic devices can be damaged by high voltage. This has to be considered during the routine testing of the luminaires in production.

According to IEC 60598-1 Annex Q (informative only!) or ENEC 303-Annex A, each luminaire should be submitted to an insulation test with 500 V<sub>DC</sub> for 1 second. This test voltage should be connected between the interconnected phase and neutral terminals and the earth terminal. The insulation resistance must be at least 2 MΩ.

As an alternative, IEC 60598-1 Annex Q describes a test of the electrical strength with 1,500 V<sub>AC</sub> (or 1,414 x 1,500 V<sub>DC</sub>). To avoid damage to the electronic devices this test must not be conducted.

### Status indication

System status is indicated by a bi-colour LED.

LED Indication	Status	Commentary
Permanent green	System OK	AC mode
Fast flashing green (0.1s on – 0.1s off)	Function test underway	
Slow flashing green (1s on – 1s off)	Duration test underway	
Red LED on	Load failure	Open circuit / Short circuit / LED failure <sup>①</sup>
Slow flashing red (1s on – 1s off)	Battery failure	Battery failed the duration test or function / Battery is defect / Incorrect battery voltage
Fast flashing red (0.1s on – 0.1s off)	Charging failure	Incorrect charging current
Double pulsing green	Rest mode	Switching into blocking mode via controller
Green and red off	DC mode	Battery operation (Emergency mode)

① If the EM powerLED is operated in non-maintained mode and an LED fault is detected, the red indicator LED will be illuminated and the output will be stopped. The unswitched mains supply must be switched off before the LED is changed in order that the new LED can be detected. A function or duration test will not reset the fault indication.

### Mechanical details

Case manufactured from polycarbonate.

Glow-wire test according to EN 61347-1 with increased temperature of 850 °C passed.

LED bi-colour status indicator

- Green / red
- Mounting hole 6.5 mm diameter, 1 – 1.6 mm thickness
- Lead length 1,000 mm
- Insulation rating: 90 °C

Test switch

- Mounting hole 7.0 mm diameter
- Lead length 550 mm

Battery leads

- Quantity: 1 red and 1 black
- Length: 1 m
- Wire type: 0.5 mm<sup>2</sup> solid conductor
- Insulation rating: 90 °C

Battery end termination

Push on 4.8 mm receptacle to suit battery spade fitted with insulating cover

Module end termination

8.0 mm stripped insulation

Two-piece batteries are supplied with a 200 mm lead with 4.8 mm receptacles at each end and insulating covers to connect the separate sticks together.

### Batteries

Connection method: 4.8 x 0.5 mm spade tag welded to end of cell

For stick packs this connection is accessible after the battery caps have been fitted.

To inhibit inverter operation disconnect the batteries by removing the connector from the battery spade tag.

For battery data see separate data sheet.

### Recommended fixing details for clip fixing

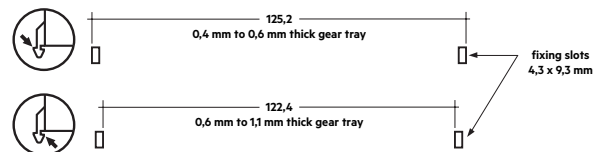

### Wiring type and cross section

#### Wiring

mains (SL, N, L)  
LED (LED +, LED -)

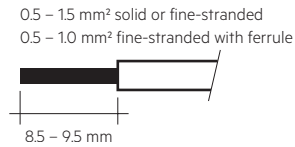

#### Wiring

batteries (Bat +, Bat -)  
test switch (switch)  
status indication LED (status K, A)

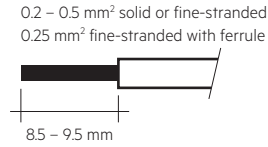

### Max. lead insulation diameter

Battery	2.1 mm
Test switch	2.1 mm
Indicator LED	2.1 mm

### Maximum lead length

LED	3 m
status indication LED	1 m
batteries	1 m

### Release of the wiring

Press down the "push button" and remove the cable from front.

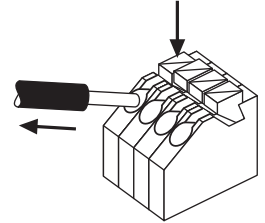

Use one wire for each terminal connector only.

### Maximum loading of automatic circuit breakers

Automatic circuit breaker type	B10	C10	B13	C13	B16	C16	B20	C20	Inrush current	
Installation Ø	1.5 mm <sup>2</sup>	1.5 mm <sup>2</sup>	1.5 mm <sup>2</sup>	1.5 mm <sup>2</sup>	2.5 mm <sup>2</sup>	2.5 mm <sup>2</sup>	2.5 mm <sup>2</sup>	2.5 mm <sup>2</sup>	I <sub>max</sub>	Time
<b>EM powerLED 4 W ST</b>	90	180	130	260	130	260	130	260	10 A	120 µs
<b>EM powerLED 4 W ST NiMH</b>	90	180	130	260	130	260	130	260	10 A	120 µs

### Insulation matrix

	Mains	Switched Live	Battery, LED, Test switch, Indicator LED	REST
Mains	-	•	••	•
Switched Live	•	-	••	•
Battery, LED, Test switch, Indicator LED	••	••	-	•
REST	•	•	•	-

- Represents basic insulation
- Represents double or reinforced insulation

### Wiring diagrams

#### Wiring diagram for one LED or two LED in series

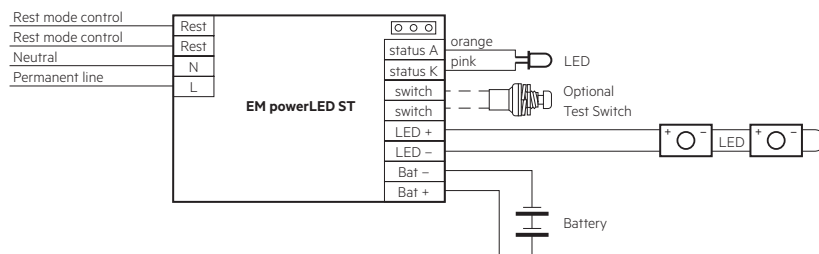

#### Wiring diagram for multiple LED (3-12) in parallel

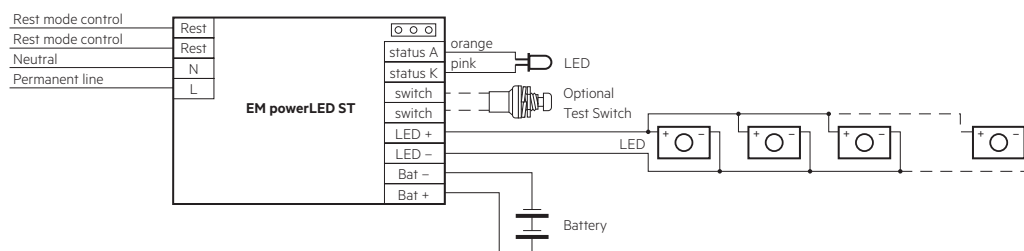

Take care that the LED is connected with the right polarity. LED that are connected to the EM powerLED PRO EZ-3 devices should have a reverse polarity protection device such as a schottky diodes fitted, otherwise irreversible damage could occur if the LED is connected in reverse polarity. Any protection device must be capable of handling in excess of 1,000 mA.

Note: Please ensure that at the terminal of the EM powerLED module the battery negative is not connected to the negative of the LED load.

### Manually tested emergency lighting with combined LED modules for general and emergency lighting (e.g. STARK QLE CLASSIC EM, STARK LLE 24-280-1250 EM, STARK CLE CLASSIC EM, STARK SLE CLASSIC EM):

Due to the fact that independent circuits are used for general and emergency lighting it is important that the normal supply of the mains LED driver is switched off together with the permanent emergency supply prior to checking the operation of the emergency LEDs.

If this is not done then it may not be possible to see that the emergency LEDs are operating.

Use a circuit similar to that shown next.

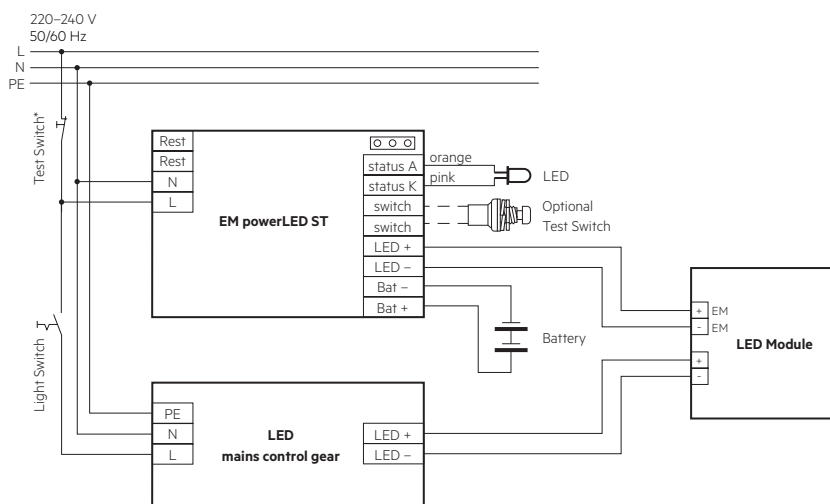

\* Use 230 V Test switch

### Wiring instructions

- The EM powerLED terminals, battery, indicator LED and test switch terminals are classified as SELV. Keep the wiring of the DALI and the input terminals separated from the wiring of the SELV terminals or consider special wiring (double insulation, 6 mm creepage and clearance) when these connections should be kept SELV.
- The output to the LED is DC but has high frequency content at 125 kHz, which should be considered for good EMC compliance.
- EM powerLED leads should be separated from the mains and DALI connections and wiring for good EMC performance. With some luminaires it may be necessary to add a ferrite bead inductor to obtain satisfactory EMC performance.
- Maximum lead length on the EM powerLED terminals is 3 m. For a good EMC performance keep the LED wiring as short as possible.
- The secondary wires (LED module) should be routed in parallel to ensure good EMC performance.
- Maximum lead length for the test switch and Indicator LED connection is 1 m. The test switch and Indicator LED wiring should be separated from the EM powerLED leads to prevent noise coupling.
- Battery leads are specified with 0.5 mm<sup>2</sup> cross section and a length of < 1.3 m.
- DALI terminals are mains proof.
- To avoid the damage of the control gear, the wiring must be protected against short circuits to earth (sharp edged metal parts, metal cable clips, louver, etc.).

### Mains-connected transformers

The EM powerLED does not contain mains-connected windings of transformers.

### FELV control terminals



FELV control terminals marked „Risk of electric shock“ are not safe to touch. Insulate circuits connected to any FELV control terminal for the Low Voltage supply voltage of the device. Protect terminals connected to the FELV circuit against accidental contact.

### Additional information

Additional technical information at [www.tridonic.com](http://www.tridonic.com) → Technical Data

Guarantee conditions at [www.tridonic.com](http://www.tridonic.com) → Services

Lifetime declarations are informative and represent no warranty claim. No warranty if device was opened.