

EM powerLED PRO FX NFC LiFePO4 1 – 2 W

Combined emergency lighting LED driver 1 – 4 W



LiFeGuard

Product description

- _ Emergency lighting LED driver with DALI interface and selftest function
- _ Fulfills DALI-2 parts: 250 (Integrated bus power supply), 251 (Luminaire data), 252 (Energy reporting) and 253 (Diagnostics & Maintenance)
- _ For self-contained emergency lighting
- _ SELV for output voltage < 60 V DC
- _ Low profile cross-section (21 x 30 mm)
- _ 5 years guarantee (conditions at <https://www.tridonic.com/en/int/services/manufacturer-guarantee-conditions>)

Properties

- _ Mains and emergency operation
- _ DALI switchable in mains operation (on/off); the switched phase SL must be switched on
- _ Constant current mode
- _ Screw fixing
- _ 1, 2 or 3 h rated duration
- _ Selectable operating time (jumper)
- _ Two-colour status display LED
- _ SELV classified (outputs powerLED, battery, status LED, test switch)
- _ Very low energy consumption from the battery after activation of the deep discharge protection

Interfaces

- _ DALI interface for controlled testing and monitoring
- _ Near field communication (NFC)

Battery management

- _ Intelligent charge system
- _ Deep discharge protection
- _ Temperature protection
- _ Reverse polarity protection

Batteries

- _ LiFePO4 batteries with Tridonic LiFeGuard
- _ Overcharge-/Overdischarge protection
- _ Ensures safety in use
- _ LiFePO4: up to 12 years design life
- _ 8 years guarantee for LiFePO4 batteries (conditions at <https://www.tridonic.com/en/int/services/manufacturer-guarantee-conditions>)^①

① 28005859 - 5-year guarantee.

Website<http://www.tridonic.com/89800809>

EM powerLED PRO FX NFC LiFePO4 1 – 2 W

Combined emergency lighting LED driver 1 – 4 W

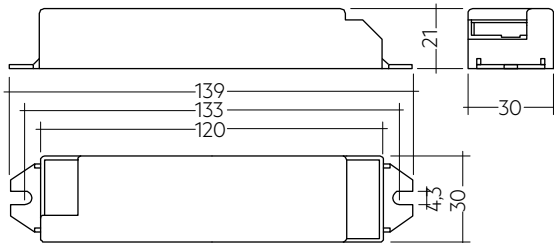
**Ordering data**

Type	Article number	Rated duration	Max. number of LEDs	Packaging, carton	Packaging, pallet	Weight per pc.
EM pLED PRO FX NF 201 LiFePO4 1W SCREW	89800809	1/2/3 h	1	10 pc(s).	800 pc(s).	0.06 kg
EM pLED PRO FX NF 201 LiFePO4 2W SCREW	89800810	1/2/3 h	2	10 pc(s).	800 pc(s).	0.06 kg

Technical data

Rated supply voltage	220 – 240 V
AC voltage range	198 – 264 V
Mains frequency	50 / 60 Hz
THD (at 230 V, 50 Hz, full load)	< 120 %
U-OUT (including open- / short-circuit and double load)	15 V
Max. open circuit voltage	15 V
Output current tolerance	± 10 %
Typical output LF current ripple at full load	± 5 %
Starting time	< 0.7 s
Output current	Refer to data sheet
Overvoltage protection	320 V (for 48 h)
Max. casing temperature tc	80 °C
Ambient temperature ta	-25 ... +55 °C
Mains voltage changeover threshold	According to EN 60598-2-22
Mains surge capability (between L - N)	1 kV
Surge voltage at output side (against PE)	< 2 kV
Mains surge capability (between L/N - PE)	2 kV
Type of protection	IP20
Lifetime	up to 100,000 h
Guarantee (conditions at www.tridonic.com)	5 Year(s)

Approval marks**Standards**

EN 61347-2-7, EN 61347-2-13, EN 62384, EN 55015, EN 61000-3-2, EN 61000-3-3, EN 61000-4-11, EN 61547, EN 60068-2-29, EN 60068-2-30, EN 60068-2-64, EN 62386 (acc. to DALI standard V2), EN 62386-101, EN 62386-102, according to EN 50172, according to EN 60598-2-22, acc. to EN 62034

Specific technical data

Type	Rated duration	Number of LEDs	Typ. λ (at 230 V, 50 Hz)	Forward voltage range LED module ^②	Non-maintained operation		Maintained operation	
					Mains current in charging operation	Mains power in charging ^④ operation	Mains current in charging operation	Mains power in charging ^④ operation
EM pLED PRO FX NF 201 LiFePO₄ 2W SCREW	1 h	1	0.58C	2.6 – 3.4 V	17 / 12 mA	1.7 / 1 W	28 / 23 mA	3.5 / 2.8 W
EM pLED PRO FX NF 201 LiFePO₄ 2W SCREW	1 h	2	0.58C	5.2 – 6.8 V	17 / 12 mA	1.7 / 1 W	39 / 33 mA	5.0 / 4.1 W
EM pLED PRO FX NF 201 LiFePO₄ 2W SCREW	2 h	1	0.58C	2.6 – 3.4 V	22 / 12 mA	2.3 / 1 W	33 / 23 mA	4.0 / 2.8 W
EM pLED PRO FX NF 201 LiFePO₄ 2W SCREW	2 h	2	0.58C	5.2 – 6.8 V	22 / 12 mA	2.3 / 1 W	44 / 33 mA	5.5 / 4.1 W
EM pLED PRO FX NF 201 LiFePO₄ 2W SCREW	3 h	1	0.58C	2.6 – 3.4 V	24 / 12 mA	2.7 / 1 W	35 / 23 mA	4.5 / 2.8 W
EM pLED PRO FX NF 201 LiFePO₄ 2W SCREW	3 h	2	0.58C	5.2 – 6.8 V	24 / 12 mA	2.7 / 1 W	46 / 33 mA	5.8 / 4.1 W
EM pLED PRO FX NF 201 LiFePO₄ 1W SCREW	1 h	1	0.55C	2.6 – 3.4 V	17 / 12 mA	1.7 / 1 W	28 / 23 mA	3.5 / 2.8 W
EM pLED PRO FX NF 201 LiFePO₄ 1W SCREW	2 h	1	0.55C	2.6 – 3.4 V	17 / 12 mA	1.7 / 1 W	28 / 23 mA	3.5 / 2.8 W
EM pLED PRO FX NF 201 LiFePO₄ 1W SCREW	3 h	1	0.55C	2.6 – 3.4 V	22 / 12 mA	2.3 / 1 W	33 / 23 mA	4.0 / 2.8 W

② When exceeding the rated power of 1 respectively 2 W the LED current is reduced proportionally.

③ For LiFePO₄ batteries voltage dependent constant current charging is used. The values displayed are for charging on / charging off.

④ Integrated DALI bus power supply is switched OFF. With the Integrated DALI bus power supply switched ON and fully loaded the input power and current is increased by 1.4 W and 9 mA in any charging mode.

Test switch EM2

Accessory



Product description

- _ For connection to the emergency lighting unit
- _ For checking the device function
- _ Dielectric strength: 1,500 V AC for 60 seconds
- _ Lead length 0.55m
- _ Mounting hole 7,0 mm diameter

Website

<http://www.tridonic.com/89805277>



Ordering data

Type	Article number	Packaging, bag	Packaging, carton	Weight per pc.
Test switch EM 2	89805277	25 pc(s).	1,800 pc(s).	0.009 kg

Approval marks

RoHS

Status indication bi-colour LED EM

Accessory



Product description

- _ Two-colour status display LED
- _ Green: system OK, red: fault

Website

<http://www.tridonic.com/89899720>



Ordering data

Type	Article number	Packaging, bag	Packaging, carton	Weight per pc.
LED EM bi-colour	89899720	25 pc(s).	200 pc(s).	0.016 kg
LED EM bi-colour, high brightness	89899753	25 pc(s).	200 pc(s).	0.016 kg

Approval marks

RoHS

Connection cable LiFePO4

Accessory

**Product description**

- _ Extension cable for LiFePO4 batteries
- _ Cable length 500 mm
- _ 3-pole plug connection

Website

<http://www.tridonic.com/28002461>

**Ordering data**

Type	Article number	Packaging, bag	Packaging, carton	Weight per pc.
EXTENSION CABLE LiFePO4 500mm	28002461	10 pc(s).	200 pc(s).	0.011 kg

EMpLED Strain-relief set 200x43x25.5mm

Accessory

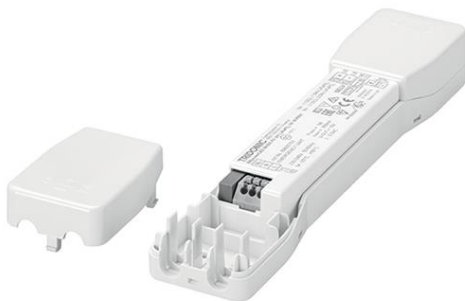
**Product description**

- _ Optional strain-relief for independent applications
- _ Transforms the LED driver into a fully class II compatible LED driver (e.g. ceiling installation)
- _ Easy and tool-free mounting to the LED driver, screwless cable-clamp channels with strain-relief (200 x 43 x 25.5 mm)

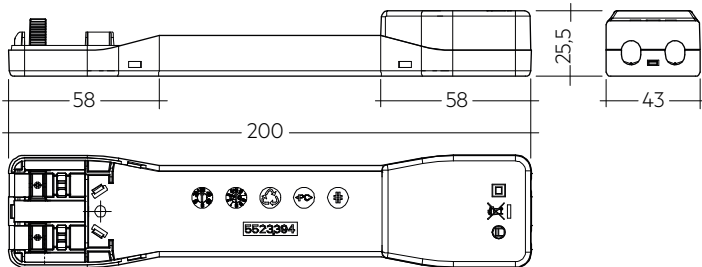

Permissible cable jacket diameter 2.2 – 9 mm

Website

<http://www.tridonic.com/28004033>



Ordering data

Type	Article number	Packaging, carton	Weight per pc.
EM pLED SR	28004033	10 pc(s).	0.05 kg

Approval marks



1. Standards

- EN 61347-2-7
- EN 61347-2-13
- EN 62384
- EN 55015
- EN 61000-3-2
- EN 61000-3-3
- EN 61000-4-11
- EN 61547
- EN 60068-2-29
- EN 60068-2-30
- EN 60068-2-64
- EN 62386 (according to DALI-2 standard)
- EN 62386-101 (DALI-2), only IPS relevant requirements
- EN 62386-102 (DALI-2), only IPS relevant requirements
- according to EN 50172
- according to EN 60598-2-22
- according to EN 62034

Meaning of marking 

Double or reinforced insulation for built-in electronic LED drivers.

1.1 Glow-wire test

according to EN 61347-1 with increased temperature of 850 °C passed.

1.2 Insulation and electric strength testing of luminaires

Electronic LED drivers can be damaged by high voltage. This has to be considered during the routine testing of the luminaires in production.

According to IEC 60598-1 Annex Q (informative only!) or ENEC 303-Annex A, each luminaire should be submitted to an insulation test with 500 V_{DC} for 1 second. This test voltage should be connected between the interconnected phase and neutral terminals and the earth terminal. The insulation resistance must be at least 2 MΩ.

As an alternative, IEC 60598-1 Annex Q describes a test of the electrical strength with 1,500 V_{AC} (or 1,414 x 1,500 V_{DC}). To avoid damage to the electronic devices this test **must not be conducted**.

2. Thermal details and lifetime

2.1 Lifetime

Average lifetime 100,000 hours under rated conditions with a failure rate of less than 10 %. Average failure rate of 0.2 % per 1000 operating hours.

Expected lifetime

EM pLED PRO FX NF 201 LiFePO ₄ 1W	ta	40 °C	50 °C	55 °C
	tc	60 °C	70 °C	75 °C
	lifetime	> 100,000 h	> 100,000 h	76,000 h
EM pLED PRO FX NF 202 LiFePO ₄ 2W	ta	40 °C	50 °C	–
	tc	65 °C	75 °C	–
	lifetime	> 100,000 h	73,000 h	–

The emergency lighting LED driver is designed for a lifetime stated above under reference conditions and with a failure probability of less than 10 %.

The relation of tc to ta temperature depends also on the luminaire design. If the measured tc temperature is approx. 5 K below tc max., ta temperature should be checked and eventually critical components (e.g. ELCAP) measured. Detailed information on request.

3. Installation / Wiring

3.1 Wiring diagram

3.1.1 Wiring with one or multiple LED modules

Serial:

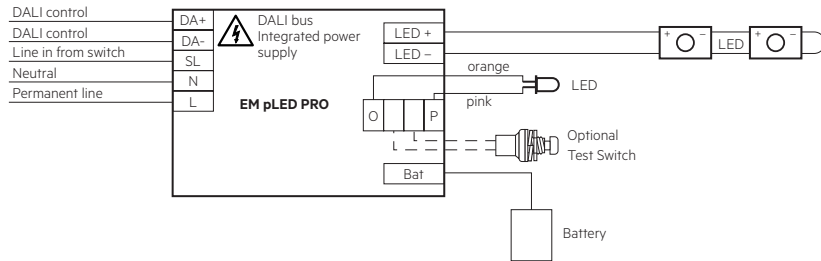

Parallel:

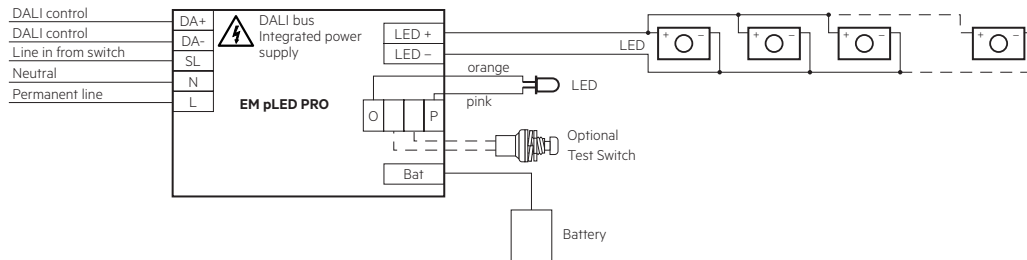

Take care that the LED is connected with the right polarity. LEDs that are connected to the EM powerLED devices should have a reverse polarity protection device such as a schottky diode fitted, otherwise irreversible damage could occur if the LED is connected in reverse polarity. Any protection device must be capable of handling in excess of 600 mA.

3.1.2 Wireless set-up

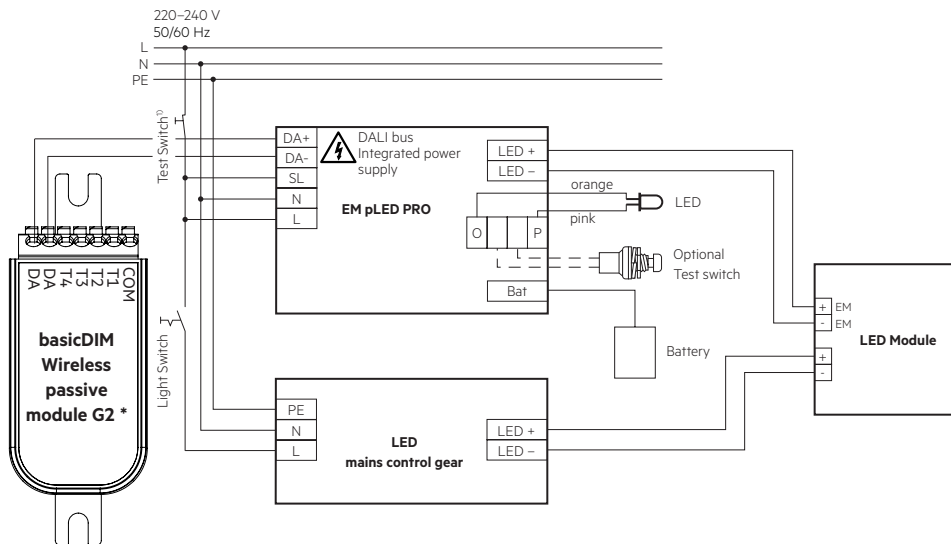

¹⁾ Use 230 V Test switch

²⁾ For further information see basicDIM Wireless datasheet at www.tridonic.com

3.2 Wiring type and cross section

LED module/LED driver/supply:

Use solid/stranded wire with a cross section of 0.5 – 1.5 mm² for wiring. Strip 8.5 – 9.5 mm of insulation from the cables to ensure perfect operation of terminals.

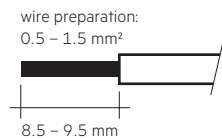

Status indication LED / Test switch:

Use solid wire with a cross section of 0.2 – 0.5 mm² for wiring. Strip 8.5 – 9.5 mm of insulation from the cables to ensure perfect operation of terminals.

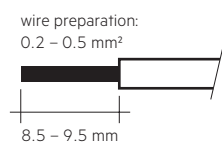

3.3 Battery connection

LiFePO₄: Direct connection

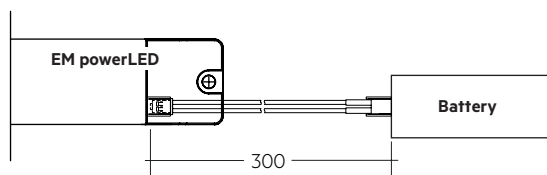

LiFePO₄: Connection with extension

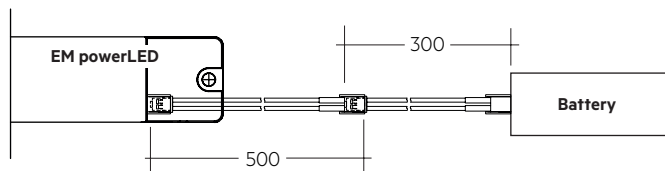

3.4 Loose wiring

Press down the “push button” and remove the cable from front.

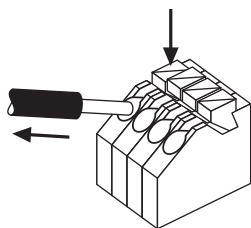

3.5 Wiring guidelines

- The LED terminals, battery, indicator LED and test switch terminals are classified as SELV (output voltage < 60 V DC). Keep the wiring of the input terminals separated from the wiring of the SELV classified terminals or consider special wiring (double insulation, 6 mm creepage and clearance) when these connections should be kept SELV.
- The output to the LED is DC but has high frequency content, which should be considered for good EMC compliance.
- LED leads should be separated from the mains connections and wiring for good EMC performance.
- Maximum lead length on the LED terminals is 3 m. For a good EMC performance keep the LED wiring as short as possible.
- The secondary wires (LED module) should be routed in parallel to ensure good EMC performance.
- Maximum lead length for the Test switch and Indicator LED connection is 1 m. The test switch and Indicator LED wiring should be separated from the LED leads to prevent noise coupling.
- Battery leads are specified with 0.5 mm cross section and a length of 0.8 m
- To avoid the damage of the control gear, the wiring must be protected against short circuits to earth (sharp edged metal parts, metal cable clips, louver, etc.)

To ensure that a luminaire containing LED emergency units complies with EN 55015 for radio frequency conducted interference in both normal and emergency mode it is essential to follow good practice in the wiring layout.

3.6 Maximum lead length

LED	3 m (6 m loop) ^①
Test switch	1 m
Status indication LED	1 m
Batteries	0.8 m

^① Note: Do not exceed the length of LED leads to the LED module. Leads should always be kept as short as possible.

4. Mechanical values

4.1 Housing properties

- Casing manufactured from polycarbonate.
- Type of protection: IP20

4.2 Mechanical data accessories

LED bi-colour status indicator

- Green / Red
- Mounting hole 6.5 mm diameter, 1 – 1.6 mm thickness
- Lead length 1.0 m
- Insulation rating: 90 °C

Test switch

- Mounting hole 7.0 mm diameter
- Lead length 0.55 m

Battery connection

- Plug connection 0.3 m
- Extension 0.5 m

5. Electrical values

5.1 Maximum loading of automatic circuit breakers

Automatic circuit breaker type	B10	B13	B16	B20	C10	C13	C16	C20	Inrush current	
Installation Ø	1.5 mm ²	1.5 mm ²	2.5 mm ²	2.5 mm ²	1.5 mm ²	1.5 mm ²	2.5 mm ²	2.5 mm ²	I _{max}	time
EM pLED PRO FX NF LiFePO4	90	130	130	130	180	260	260	260	6 A	55 µs

5.2 Insulation matrix

	Mains	Switched Live	Battery, Test switch, Indicator LED	DALI
Mains	–	•	••	•
Switched Live	•	–	••	•
Battery, Test switch, Indicator LED	••	••	–	•
DALI	•	•	•	–

• Represents basic insulation

•• Represents double or reinforced insulation

DALI terminals are not SELV. Wire the terminals in accordance with the requirements of low voltage installations.

5.3 LED current

EM pLED PRO FX LiFePO₄, 1 / 2 / 3 h

Type	EM pLED PRO FX NF 201 LiFePO ₄ 1W	EM pLED PRO FX NF 202 LiFePO ₄ 2W
Article no.	89800809	89800810
LED current in emergency operation 1 x LED	350 mA	600 mA
2 x LED	-	350 mA
LED current in mains operation 1 x LED	350 mA	350 mA
2 x LED	-	350 mA

5.4 Emergency output factor EOFi

EM pLED PRO FX LiFePO₄, 1 / 2 / 3 h

Type	EM pLED PRO FX NF 201 LiFePO ₄ 1W	EM pLED PRO FX NF 202 LiFePO ₄ 2W
Article no.	89800809	89800810
Cells	1 / 2 cells	1 / 2 / 3 cells
LED load	Output current	LED load
1 x LED	350 mA	97 %
1 x LED	600 mA	-
2 x LED	350 mA	170 %
		97 %

6. Interfaces / communication

6.1 Control input (DA+, DA-)

The DALI Interface allows communication with the Driver via a suitable DALI control unit. The DALI interface is not SELV. Install the control cable (DALI bus) in accordance to the requirements of low voltage installations. DALI terminals are mains voltage proof.

6.2 Nearfield communication (NFC)

The NFC Interface allows wireless communication with the LED driver in unpowered state. This interface offers the option to write configuration and to read configuration, errors and events via a suitable NFC antenna and the companionSUITE software.

Place the NFC antenna directly on the LED driver to guarantee a correct communication between the LED driver and the NFC antenna. Any material placed between the LED driver and the NFC antenna can cause a deterioration of the communication quality. We recommend the use of following NFC antennas:

www.tridonic.com/nfc-readers.

NFC is complied with ISO/IEC 15963 standard.

After programming the device via NFC power up the device one time for one second till the deviceANALYSER can read out the parameters.

Changing parameters via NFC shall be done by qualified engineers only.

7. Functions

7.1 Integrated DALI bus power supply voltage (IPS)

The function is activated by default and can be optionally deactivated.

IPS = 50 mA and IPS_max = 62.5 mA.

The minimum guaranteed output current is 50 mA.

I_{max} = 62.5 mA



Note: The voltage drop in the DALI wires must not exceed 2 V.



No other DALI power supply is allowed to be connected in parallel.

If the IPS function is activated, do not integrate the Driver into an existing DALI network with active DALI bus power supply.

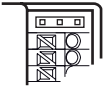
7.2 Duration link selection

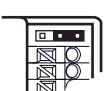
Duration	Link Position
1 hr	 without jumper
2 hr	 position A
3 hr	 position B

The device is supplied with the duration link in 3 hours position (position B).

The position of the link will only be read on first power up. If it is changed afterwards disconnect both the battery and mains supply for 10 seconds to enable the EM powerLED to read the new link position after reconnection of the battery and mains. A change of the link position without this reset leads to a false battery failure indication.

7.3 Status indication

System status is indicated by a bi-colour LED and by a DALI status flag.

LED indication	Status	Commentary
Permanent green	System OK	AC mode
Fast flashing green (0,1 sec on – 0,1 sec off)	Function test underway	
Slow flashing green (1 sec on – 1 sec off)	Duration test underway	
Red LED on	Load failure	Open circuit / Short circuit / LED failure [ⓐ]
Slow flashing red (1 sec on – 1 sec off)	Battery failure	Battery failed the duration test or function / Battery is defect / Incorrect battery voltage
Fast flashing red (0,1 sec on – 0,1 sec off)	Charging failure	Incorrect charging current
Double pulsing green	Inhibit mode	Switching into inhibit mode via controller
Binary transmission of address via green/red LED	Address identification	During address identification mode
Green and red off	DC mode	Battery operation (emergency mode)

[ⓐ] If the EM powerLED (operated in non-maintained mode) detects a fault at the LED module, the red LED indicator lights up and the output is stopped. After the correction of the fault disconnect the unswitched phase from the mains supply or carry out a function or duration test. This will detect the new LED module and reset the error display.

7.4 Testing

DALI Control

A DALI command from a suitable control unit can be used to initiate function and duration tests at individually selected times. Status flags are set for report back and data logging of results.

When a DALI bus has not been connected or when a DALI bus is connected but the DALI default DELAY and INTERVAL times have not been re-set by sending appropriate DALI commands, then the EM powerLED will conduct self-tests in accordance with the default times set within the EEPROM. These default times are factory pre-set, in accordance with the DALI standard EN 62386-202, to conduct an automatic function test every 7 days and a duration test every 52 weeks. Since the DELAY time is factory pre-set to Zero, all units are tested at the same time. Test times can be changed with a command over the DALI bus.

The DELAY and INTERVAL time values must be re-set when the emergency system test times are to be scheduled by a DALI control and monitoring system.

Note that once the default values have been set to Zero, tests will only be conducted following a command from the control system. If the DALI bus is disconnected the EM powerLED does not revert to self-testing mode.

Commissioning

After installation of the luminaire and initial connection of the mains supply and battery supply to the EM powerLED the unit will commence charging the batteries for 24 hours (initial charge). Afterwards the module will conduct a commissioning test for the full duration. The 24 hours recharge occurs also if a new battery is connected or the module exits the rest mode condition. The following automatic commissioning duration test is only performed when a battery is replaced and fully charged (after 24 hrs) and the interval time is not set to zero, otherwise the system is expected to perform the testing.

Functional test

The time of day and frequency of the 5 seconds function test can be set by the DALI controller. The default setting is a 5 seconds test on a weekly basis.

Duration test

The time of day and frequency of the duration test can be set by the DALI controller. The default setting is a duration test conducted every 52 weeks.

Prolong time

Prolong time can be set by the DALI controller. This is the delay time between return of the mains supply and the end of the emergency operation. The default prolong time is set as 0 minutes as specified within the DALI standard.

Indicator LED will stay off for the duration of the prolong time.

Timer reset functionality

The timer for function and duration test can be set to a particular time of the day by either pressing the test switch for longer than 10 seconds or cycling the unswitched line supply 5 times within 1 minute. The timer adjustment will enable the test start time to be defined manually at time in day when the timer was reset. It will also disable the adaptive test algorithm thereby forcing the unit to perform the test at the same time rather than it being defined by the adaptive algorithm. This function will only work provided the interval time is greater than zero (automatic test mode enabled). The delay timer value set when the unit was commissioned will be reloaded in order to randomise the tests between adjacent units.

The factory programmed delay offset (1 – 28 days) will be loaded after the reset into the delay timer for the function and duration test in order to randomize the tests between adjacent units.

Rest Mode / Inhibit Mode

Emergency operation is automatically started when the mains supply is switched off. If the Rest Mode is activated, the discharging of the battery will be minimized by switching off the LED output. If the Inhibit Mode has been activated before the mains supply is switched off, Rest Mode will be automatically switched on if the mains supply is switched off within 15 minutes. Rest Mode and Inhibit Mode can be initiated by the DALI controller. The REST command has to be sent after the mains supply has been disconnected and whilst the EM powerLED is in emergency operation. The INHIBIT command has to be sent while the EM powerLED is supplied by mains. After a mains reset the EM powerLED exits the Rest Mode. Rest Mode and Inhibit Mode can both be disabled by sending the RE-LIGHT/RESET INHIBIT command.

In combination with a 1-cell battery the EM powerLED does not support Rest Mode / Inhibit Mode.

Test switch

An optional test switch can be wired to each EM powerLED. This can be used to initiate a 5 seconds function test by a short press < 1 second.

DALI Controller

DALI controllers and hardware/software solutions are available from Tridonic. Please refer to the Lighting controls section.

Luminaire data



This function provides the asset management with accurate data about the luminaire.

DALI Part 251: Memory bank 1 extension.

8. Battery data

8.1 Battery selection

EM pLED PRO FX LiFePO₄, 1 / 2 / 3 h

		Type	EM pLED PRO FX NF 201 LiFePO ₄ 1W			EM pLED PRO FX NF 202 LiFePO ₄ 2W			
		Article no.	89800809			89800810			
		Duration	1 h	2h	3 h	1 h	2h	3 h	
		Cells	1	1	2	1	2	3	
Technology andDesign capacity	Number of cells	Type	Assignable batteries						
LiFePO ₄ , 1.5 Ah 18650 cells	stick	1 x 1	ACCU-LiFePO ₄ 1A CON	28002317	•	•		•	
	stick	1 x 2	ACCU-LiFePO ₄ 2A CON	28002318			•	•	
	stick	1 x 3	ACCU-LiFePO ₄ 3A CON	28002320					•
	side by side	2 x 1	ACCU-LiFePO ₄ 2B CON	28002319			•	•	
	side by side	3 x 1	ACCU-LiFePO ₄ 3B CON	28002321					•
	remote box	1 x 1	PACK-LiFePO ₄ 1.5Ah 1 CON	28003804	•	•			
	remote box	1 x 3	PACK-LiFePO ₄ 4.5Ah 3 CON	28003806					•
	remote box	1 x 2	PACK-LiFePO ₄ 3.0Ah 2 CON	28005854			•	•	
	remote box	1 x 3	PACK-LiFePO ₄ 4.5Ah 3 CON	28005855					•
	remote box	1S1P	PACK-LiFePO ₄ 3.3Ah 1 CON	28005859			•	•	

8.2 Battery charge / discharge data

EM pLED PRO FX LiFePO₄, 1 / 2 / 3 h

		Type	EM pLED PRO FX NF 201 LiFePO ₄ 1W			EM pLED PRO FX NF 202 LiFePO ₄ 2W		
		Article no.	89800809			89800810		
		Duration	1 h	2 h	3 h	1 h	2 h	3 h
Battery charge time	Initial charge	24 h						
	Trickle charge	continuously						
Charging current	Initial charge	120 – 150 mA	120 – 150 mA	240 – 300 mA	120 – 150 mA	240 – 300 mA	300 – 360 mA	
	Trickle charge [®]	120 – 150 mA / 0 mA	120 – 150 mA / 0 mA	240 – 300 mA / 0 mA	120 – 150 mA / 0 mA	240 – 300 mA / 0 mA	300 – 360 mA / 0 mA	
Discharge current		430 – 530 mA			800 – 970 mA			
Charge voltage range [®]		2.0 – 3.6 V						
Discharge voltage range		2.3 – 3.6 V						

[®] Automatic recharge when battery voltage falls below 3.4 V. Charger off (0 mA) when battery voltage exceeds 3.6 V.

Note: Battery protected against operation at excessive temperatures (charging stopped when battery cell temperature < 0 °C or > 60 °C).

The emergency lighting LED driver will recharge the battery normally after running the test of 61347-2-7 CL 22.3 (abnormal operating conditions).

[®] The battery will not be charged below 2.0 V.

8.3 ACCU-LiFePO4**Capacity 1.5 Ah**

International designation	IFpR 19/66
Battery voltage/cell	3.2 V
Cell type	18650
Case temperature range to ensure	
5 years design life	+5 °C to +60 °C
7 years design life	+5 °C to +55 °C
10 years design life	+5 °C to +45 °C
12 years design life	+5 °C to +35 °C
Max. short term battery case temperature (shorter than 1 month over the battery lifetime)	70 °C
Max. number discharge cycles	50 cycles total
Max. storage time	15 months at -20 °C to +35 °C

8.4 ACCUpack-LiFePO4**Capacity 1.5 Ah**

International designation	IFpR 19/66
Battery voltage/cell	3.2 V
Cell type	18650
Case temperature range to ensure	
4 years design life	+5 °C to +45 °C
6 years design life	+5 °C to +35 °C
8 years design life	+5 °C to +25 °C
Max. short term battery case temperature (shorter than 1 month over the battery lifetime)	70 °C
Max. number discharge cycles	50 cycles total
Max. storage time	15 months at -20 °C to +35 °C

Comply with UN 38.3 and IEC 62133 (safety testing) protected against over charge, over discharge, charging at excessive temperatures, short-circuit and over current.

Only use Tridonic batteries.

8.5 Accupack-LiFePO4**Capacity 3.3 Ah**

International designation	IFpR 27/66
Battery voltage/cell	3.2 V
Cell type	26650
Case temperature range to ensure	
4 years design life	+5 °C to +45 °C
6 years design life	+5 °C to +35 °C
8 years design life	+5 °C to +25 °C
Max short term battery case tc point temperature (reduced lifetime)	70 °C
Max. number discharge cycles	50 cycles total
Max. storage time	15 months at -20 °C to +35 °C

8.6 Safety

Note: LiFeGuard ensures safe and reliable battery operation by offering a comprehensive three-layered safety system. It addresses the cell, battery pack and emergency driver.

8.6.1 Deep discharge protection

When the battery remains connected without charging for a long period of time after the battery cut off of the driver the battery voltage can still drop. To make sure the cells are not damaged by this voltage drop, the battery protection prevents the battery from further discharge below 2.0 V.

8.6.2 Overcharge protection

If in case of an error or the use of a wrong driver the battery gets overcharged the battery protection will disconnect the battery from the driver at a voltage of 3.9 V. A discharge of the battery is still possible after the protection circuit was triggered to guarantee emergency operation.

8.6.3 Short-circuit protection

In case of a short circuit the battery protection opens the connection to the driver and the output is therefore free of voltage. The output will be reactivated again when the short circuit is removed.

8.6.4 Temperature protection

The battery is protected against temporary thermal overheating. If the temperature limit is exceeded the further charging of the battery is no longer possible. The temperature protection is activated below approx. 0 °C and above approx. +60 °C. The discharging of the battery is still possible to guarantee emergency operation. The charging is automatically activated when the temperature is within the range of 0 to 60°C again.



Battery has built in thermal sensor for safe charging. Mount battery away from heat source.

Positioning of the thermal sensor see battery data sheet.

8.7 Wiring batteries

To inhibit inverter operation disconnect the batteries by removing the connection at battery side.

For further informations refer to corresponding battery datasheet.

8.8 Storage, installation and commissioning

Relevant information about storage conditions, installation and commissioning are provided in the battery datasheets.

9. Miscellaneous

9.1 Battery replacement

After a battery replacement and a subsequent full charge cycle (24 h) a duration test is mandatory to prove that with the new battery the rated duration is achieved.

9.2 Mains-connected transformers

The EM powerLED does not contain mains-connected windings of transformers.

9.3 FELV control terminals



FELV control terminals marked „Risk of electric shock“ are not safe to touch. Insulate circuits connected to any FELV control terminal for the Low Voltage supply voltage of the control gear. Protect terminals connected to the FELV circuit against accidental contact.

9.4 Additional information

Additional technical information at www.tridonic.com → Technical Data

Guarantee conditions at www.tridonic.com → Services

Lifetime declarations are informative and represent no warranty claim.
No warranty if device was opened.