

EM powerLED BASIC FX LiFePO4 1 – 2 W

Combined emergency lighting LED driver 1 – 4 W



LiFeGuard

Product description

- _ Self contained emergency lighting LED driver for manual testing
- _ Non-maintained and maintained operation
- _ For luminaire installation
- _ EM = Emergency
- _ Nominal lifetime up to 100,000 h
- _ 5 years guarantee (Conditions at <https://www.tridonic.com/en/int/services/manufacturer-guarantee-conditions>)

Functions

- _ 1 or 3 h rated duration depending on connected battery
- _ For 1 or 2 LEDs connected in series
- _ Automatic detection of connected LED load
- _ Switched live for switching the LED output

Battery management

- _ Intelligent charge system
- _ Deep discharge protection
- _ Temperature protection
- _ Polarity reversal protection for battery provided by 3-pole connector

Batteries

- _ LiFePO4 batteries with Tridonic LiFeGuard
- _ Temperature-protected
- _ Overcharge-/Overdischarge protection
- _ Ensures safety in use
- _ LiFePO4: up to 12 years design life
- _ 8 years guarantee for LiFePO4 batteries (Conditions at <https://www.tridonic.com/en/int/services/manufacturer-guarantee-conditions>)^①
- _ For battery compatibility refer to data sheet, battery selection

① 28005859 - 5 Jahre Garantie. 28006323 - 4 Jahre Garantie.

Website

<http://www.tridonic.com/89800701>



EM powerLED BASIC FX LiFePO4 1 – 2 W

Combined emergency lighting LED driver 1 – 4 W

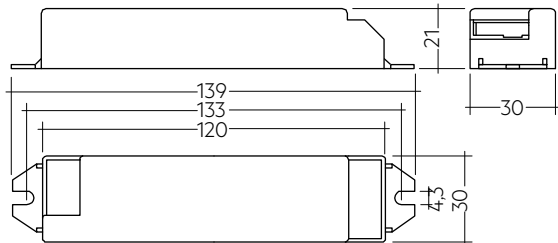

Screw-fix

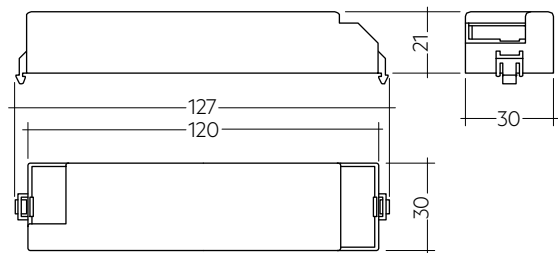

Clip-fix

Ordering data

Type	Article number	Dimensions L x W x H	Rated duration	Max. number of LEDs	Packaging, carton	Packaging, pallet	Weight per pc.
Screw fastening version							
EM powerLED BASIC FX 201 LiFePO4 1W SCREW	89800701	139 x 30 x 21 mm	1/3 h	1	25 pc(s).	1,200 pc(s).	0.05 kg
EM powerLED BASIC FX 202 LiFePO4 2W SCREW	89800702	139 x 30 x 21 mm	1/3 h	2	25 pc(s).	1,200 pc(s).	0.05 kg
Clip fastening version							
EM powerLED BASIC FX 201 LiFePO4 1W CLIP	89800703	127 x 30 x 21 mm	1/3 h	1	25 pc(s).	1,200 pc(s).	0.05 kg
EM powerLED BASIC FX 202 LiFePO4 2W CLIP	89800704	127 x 30 x 21 mm	1/3 h	2	25 pc(s).	1,200 pc(s).	0.05 kg

Technical data

Rated supply voltage	220 – 240 V
AC voltage range	198 – 264 V
Mains frequency	50 / 60 Hz
Overvoltage protection	320 V (for 48 h)
THD (at 230 V, 50 Hz, full load)	< 120 %
U-OUT (including open- / short-circuit and double load)	15 V
Max. open circuit voltage	15 V
Output current tolerance	± 10 %
Typical output LF current ripple at full load	± 5 %
Starting time (at 230 V, 50 Hz, full load)	< 0.5 s
Output current	Refer to data sheet
Ambient temperature ta	-25 ... +55 °C
Max. casing temperature tc	75 °C
Mains voltage changeover threshold	According to EN 60598-2-22
Mains surge capability (between L - N)	1 kV
Surge voltage at output side (against PE)	< 1.5 kV
Mains surge capability (between L/N - PE)	2 kV
Type of protection	IP20
Lifetime	up to 100,000 h
Guarantee (conditions at www.tridonic.com)	5 Year(s)

Approval marks



Standards

EN 61347-2-7, EN 61347-2-13, EN 62384, EN 55015, EN 61000-3-2, EN 61547, EN 60068-2-29, EN 60068-2-30, EN 60068-2-64, according to EN 50172, according to EN 60598-2-22

Specific technical data

Type	Rated duration	Number of LEDs	Typ. λ (at 230 V, 50 Hz)	Forward voltage range LED module ^②	Non-maintained operation		Maintained operation	
					Mains current in charging operation ^③	Mains power in charging operation ^③	Mains current in charging operation ^③	Mains power in charging operation ^③
EM powerLED BASIC FX 201 LiFePO4 1W SCREW	1 / 3 h	1	0.55C	2.4 – 3.4 V	16 / 9 mA	1.6 / 0.8 W	27 / 21 mA	3.5 / 2.5 W
EM powerLED BASIC FX 202 LiFePO4 2W SCREW	1 / 3 h	1	0.58C	2.4 – 3.4 V	21 / 10 mA	2.4 / 0.8 W	32 / 21 mA	4.1 / 2.4 W
EM powerLED BASIC FX 202 LiFePO4 2W SCREW	1 / 3 h	2	0.58C	4.8 – 6.8 V	21 / 10 mA	2.4 / 0.8 W	41 / 30 mA	5.4 / 3.8 W
EM powerLED BASIC FX 201 LiFePO4 1W CLIP	1 / 3 h	1	0.55C	2.4 – 3.4 V	16 / 9 mA	1.6 / 0.8 W	27 / 21 mA	3.5 / 2.5 W
EM powerLED BASIC FX 202 LiFePO4 2W CLIP	1 / 3 h	1	0.58C	2.4 – 3.4 V	21 / 10 mA	2.4 / 0.8 W	32 / 21 mA	4.1 / 2.4 W
EM powerLED BASIC FX 202 LiFePO4 2W CLIP	1 / 3 h	2	0.58C	4.8 – 6.8 V	21 / 10 mA	2.4 / 0.8 W	41 / 30 mA	5.4 / 3.8 W

② When exceeding the rated power of 1 respectively 2 W the LED current is reduced proportionally.

③ For LiFePO4 batteries voltage dependent constant current charging is used. The values displayed are for charging on / charging off.

Test switch EM2

Accessory



Product description

- _ For connection to the emergency lighting unit
- _ For checking the device function
- _ Dielectric strength: 1,500 V AC for 60 seconds
- _ Lead length 0.55m
- _ Mounting hole 7,0 mm diameter

Website

<http://www.tridonic.com/89805277>



Ordering data

Type	Article number	Packaging, bag	Packaging, carton	Weight per pc.
Test switch EM 2	89805277	25 pc(s).	1,800 pc(s).	0.009 kg

Approval marks

RoHS

Status indication green LED EM

Accessory



Product description

- _ A green LED indicates that charging current is flowing into the battery

Website

<http://www.tridonic.com/89899605>



Ordering data

Type	Article number	Packaging, bag	Packaging, carton	Weight per pc.
LED EM green	89899605	25 pc(s).	200 pc(s).	0.013 kg
LED EM green, ultra high brightness	89899756	25 pc(s).	200 pc(s).	0.013 kg

Approval marks

RoHS

Connection cable LiFePO4

Accessory



Product description

- _ Extension cable for LiFePO4 batteries
- _ Cable length 500 mm
- _ 3-pole plug connection

Website

<http://www.tridonic.com/28002461>



Ordering data

Type	Article number	Packaging, bag	Packaging, carton	Weight per pc.
EXTENSION CABLE LiFePO4 500mm	28002461	10 pc(s).	200 pc(s).	0.011 kg

EMpLED Strain-relief set 200x43x25.5mm

Accessory



Product description

- _ Optional strain-relief for independent applications
- _ Transforms the LED driver into a fully class II compatible LED driver (e.g. ceiling installation)
- _ Easy and tool-free mounting to the LED driver, screwless cable-clamp channels with strain-relief (200 x 43 x 25.5 mm)

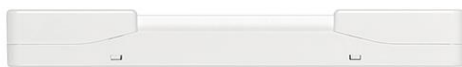

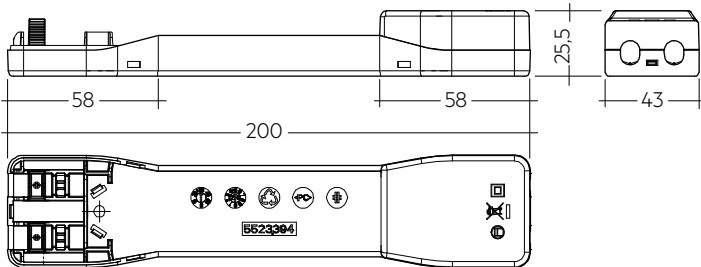

Permissible cable jacket diameter 2.2 – 9 mm

Website

<http://www.tridonic.com/28004033>



Ordering data

Type	Article number	Packaging, carton	Weight per pc.
EM pLED SR	28004033	10 pc(s).	0.05 kg

Approval marks



1. Standards

- EN 61347-2-7
- EN 61347-2-13
- EN 62384
- EN 55015
- EN 61000-3-2
- EN 61547
- EN 60068-2-29
- EN 60068-2-30
- EN 60068-2-64
- according to EN 50172
- according to EN 60598-2-22

Meaning of marking 

Double or reinforced insulation for built-in electronic LED Drivers. The control gear relies upon the luminaire enclosure for protection against accidental contact with live parts.

1.1 Glow-wire test

according to EN 61347-1 with increased temperature of 850 °C passed.

1.2 Insulation and electric strength testing of luminaires

Electronic LED-Drivers can be damaged by high voltage. This has to be considered during the routine testing of the luminaires in production.

According to IEC 60598-1 Annex Q (informative only!) or ENEC 303-Annex A, each luminaire should be submitted to an insulation test with 500 V_{DC} for 1 second. This test voltage should be connected between the interconnected phase and neutral terminals and the earth terminal. The insulation resistance must be at least 2 MΩ.

As an alternative, IEC 60598-1 Annex Q describes a test of the electrical strength with 1,500 V_{AC} (or 1,414 x 1,500 V_{DC}). To avoid damage to the electronic devices this test **must not be conducted**.

2. Thermal details and lifetime

2.1 Lifetime

Average lifetime 50,000 hours under rated conditions with a failure rate of less than 10 %. Average failure rate of 0.2 % per 1000 operating hours.

Expected lifetime

EM powerLED BASIC FX LiFePO4	tc	60 °C	65 °C	70 °C	75 °C
	lifetime	100,000 h	100,000 h	70,000 h	50,000 h

The emergency lighting LED Driver is designed for a lifetime stated above under reference conditions and with a failure probability of less than 10 %.

The relation of tc to ta temperature depends also on the luminaire design. If the measured tc temperature is approx. 5 K below tc max., ta temperature should be checked and eventually critical components (e.g. ELCAP) measured. Detailed information on request.

3. Installation / Wiring

3.1 Wiring diagram

One or two LED modules can be connected to the EM powerLED. These LED module(s) are operated in emergency mode from the associated battery. In normal mains mode all LED modules are operated from the mains supply.

Use of the test switch:

For checking the device function press the test switch for a minimum of 3 seconds.

Wiring diagram for one LED or two LED in series

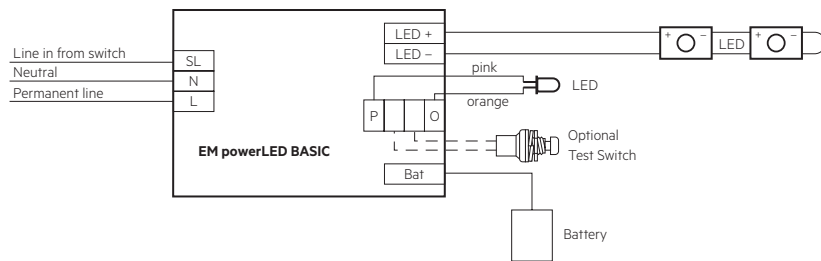

Wiring diagram for multiple LED (3-12) in parallel

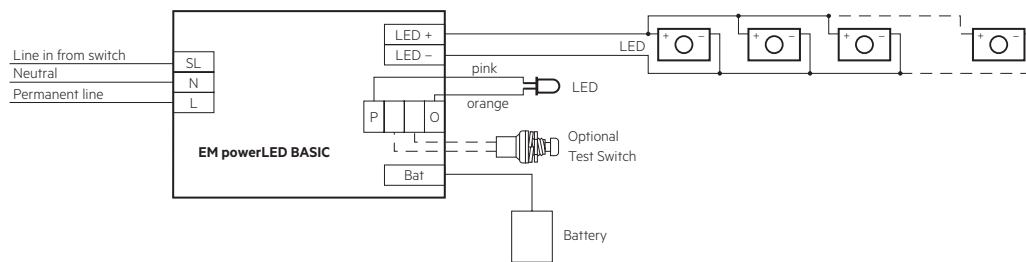

Take care that the LED is connected with the right polarity. LED that are connected to the EM powerLED devices should have a reverse polarity protection device such as a schottky diodes fitted, otherwise irreversible damage could occur if the LED is connected in reverse polarity. Any protection device must be capable of handling in excess of 600 mA.

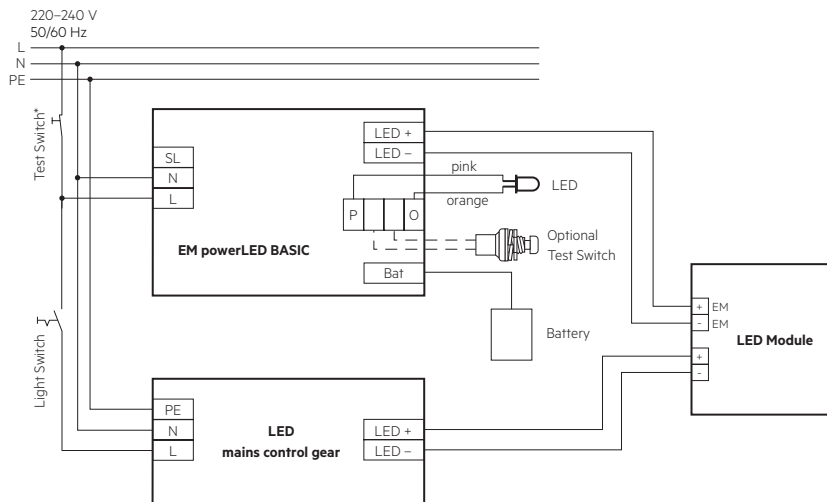

* Use 230 V Test switch

Due to the fact that independent circuits are used for general and emergency lighting it is important that the normal supply of the mains LED Driver is switched off together with the permanent emergency supply prior to checking the operation of the emergency LEDs.

If this is not done then it may not be possible to see that the emergency LEDs are operating.

Use a circuit similar to that shown next.

3.2 Wiring type and cross section

Solid wire with a cross section of 0.5 – 1.5 mm². Strip 8.5 – 9.5 mm of insulation from the cables to ensure perfect operation of terminals.

Wiring: LED module/LED Driver/supply

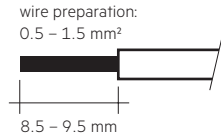

3.3 Battery connection

LiFePO₄: Direct connection

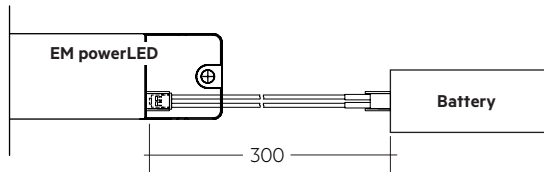

LiFePO₄: Connection with extension

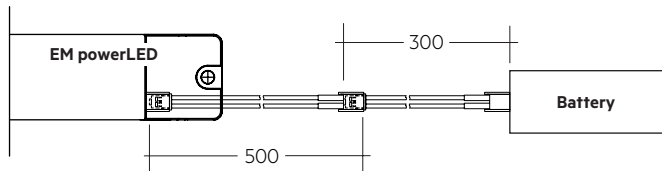

3.4 Loose wiring

Press down the “push button” and remove the cable from front.

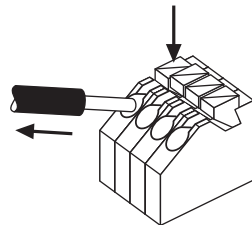

3.5 Wiring guidelines

- The LED terminals, battery, indicator LED and test switch terminals are classified as SELV (output voltage < 60 V DC). Keep the wiring of the input terminals separated from the wiring of the SELV classified terminals or consider special wiring (double insulation, 6 mm creepage and clearance) when these connections should be kept SELV.
- The output to the LED is DC but has high frequency content, which should be considered for good EMC compliance.
- LED leads should be separated from the mains connections and wiring for good EMC performance.
- Maximum lead length on the LED terminals is 3 m. For a good EMC performance keep the LED wiring as short as possible.
- The secondary wires (LED module) should be routed in parallel to ensure good EMC performance.
- Maximum lead length for the Test switch and Indicator LED connection is 1 m. The test switch and Indicator LED wiring should be separated from the LED leads to prevent noise coupling.
- Battery leads are specified with 0.5 mm cross section and a length of 0.8 m
- To avoid the damage of the control gear, the wiring must be protected against short circuits to earth (sharp edged metal parts, metal cable clips, louver, etc.)

To ensure that a luminaire containing LED emergency units complies with EN 55015 for radio frequency conducted interference in both normal and emergency mode it is essential to follow good practice in the wiring layout.

Within the luminaire the switched and unswitched 50 Hz supply wiring must be routed as short as possible and be kept as far away as possible from the LED leads. Through wiring may affect the EMC performance of the luminaire.

3.6 Maximum lead length

LED	3 m (6 m loop) [Ⓢ]
Test switch	1 m
Status indication LED	1 m
Batteries	0.8 m

[Ⓢ] Note: Do not exceed the length of LED leads to the LED module. Leads should always be kept as short as possible.

3.7 Use of different phases

The use of different phases for switched line and unswitched line is allowed. When using different phases, the unswitched line must fail if the switched line fails. This is required to assure correct switching into emergency mode. It can be realised with a relay.

4. Mechanical values

4.1 Housing properties

- Casing manufactured from polycarbonate.
- Type of protection: IP20

Recommended fixing details for clip fixing

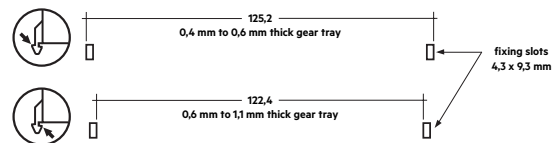

Max. torque for mounting screws: 0.8 Nm

4.2 Mechanical data accessories

LED status indicator

- Green
- Mounting hole 6.5 mm diameter, 1 – 1.6 mm thickness
- Lead length 0.3 m / 0.6 m / 1.0 m
- Insulation rating: 90 °C

Test switch

- Mounting hole 7.0 mm diameter
- Lead length 0.55 m

Battery connection

- Plug connection 0.3 m
- Extension 0.5 m

5. Electrical values

5.1 Maximum loading of automatic circuit breakers

Automatic circuit breaker type	B10	B13	B16	B20	C10	C13	C16	C20	Inrush current
Installation \emptyset	1.5 mm ²	1.5 mm ²	2.5 mm ²	2.5 mm ²	1.5 mm ²	1.5 mm ²	2.5 mm ²	2.5 mm ²	I _{max} time
EM powerLED BASIC FX LiFePO4	90	130	130	130	180	260	260	260	5 A 55 μ s

5.2 Insulation matrix

	Mains	Switched Live	Battery, LED, Test switch, Indicator LED
Mains	–	•	••
Switched Live	•	–	••
Battery, LED, Test switch, Indicator LED	••	••	–

• Represents basic insulation

•• Represents double or reinforced insulation

5.3 LED current

EM powerLED 1-2 W BASIC, 1 / 3 h

Type	EM powerLED BASIC FX LiFePO4 1W	EM powerLED BASIC FX LiFePO4 2W
Article no.	89800701, 89800703	89800702, 89800704
LED current in emergency operation 1 x LED	350 mA	600 mA
2 x LED	–	350 mA
LED current in mains operation 1 x LED	350 mA	350 mA
2 x LED	–	350 mA

5.4 Emergency output factor EOFi

EM powerLED BASIC FX LiFePO4, 1/2/3 h

Type	EM powerLED BASIC FX LiFePO4 1W	EM powerLED BASIC FX LiFePO4 2W
Article no.	89800701, 89800703	89800702, 89800704
Cells	1 / 2 cells	2 / 3 cells
LED load	Output current	LED load
1 x LED	350 mA	100 %
1 x LED	600 mA	–
2 x LED	350 mA	170 %
		100 %

6. Battery data

6.1 Battery selection

EM powerLED BASIC FX LiFePO₄, 1 / 3 h

		Type	EM powerLED BASIC FX LiFePO ₄ 1W		EM powerLED BASIC FX LiFePO ₄ 2W	
		Article no.	89800701, 89800703		89800702, 89800704	
		Duration	1 h	3 h	1 h	3 h
		Cells	1	2	2	3
Technology and Design capacity	Number of cells	Type	Article no.	Assignable batteries		
LiFePO ₄ , 1.5 Ah 18650 cells	stick	1 x 1	Accu-LiFePO ₄ 1A CON	28002317	•	
	stick	1 x 2	Accu-LiFePO ₄ 2A CON	28002318	•	•
	stick	1 x 3	Accu-LiFePO ₄ 3A CON	28002320		•
	side by side	2 x 1	Accu-LiFePO ₄ 2B CON	28002319	•	•
	side by side	3 x 1	Accu-LiFePO ₄ 3B CON	28002321		•
	remote box	1 x 3	PACK-LiFePO ₄ 4.5Ah 3 CON	28003806		•
	remote box	1 x 2	PACK-LiFePO ₄ 3.0Ah 2 CON	28005854	•	•
	remote box	1 x 3	PACK-LiFePO ₄ 4.5Ah 3 CON	28005855		•
	stick	1S1P	Accu-LiFePO ₄ 1A CON	28006323	•	•
	remote box	1S1P	PACK-LiFePO ₄ 3.3Ah 1 CON	28005859	•	•

6.2 Battery charge / discharge data

EM powerLED BASIC FX LiFePO₄, 1 / 3 h

		Type	EM powerLED BASIC FX LiFePO ₄ 1W		EM powerLED BASIC FX LiFePO ₄ 2W	
		Article no.	89800701, 89800703		89800702, 89800704	
		Duration	1 / 3 h		1 / 3 h	
Battery charge time	Initial charge	24 h				
	Trickle charge	continuously				
Charging current	Initial charge	145 – 185 mA		310 – 350 mA		
	Trickle charge ^①	145 – 185 mA / 0 mA		310 – 350 mA / 0 mA		
Discharge current		455 – 505 mA		815 – 865 mA		
Charge voltage range ^②		2.0 – 3.6 V per cell				
Discharge voltage range		2.3 – 3.6 V per cell				

^① Automatic recharge when battery voltage falls below 3.4 V. Charger off (0 mA) when battery voltage exceeds 3.6 V.

Note: Battery protected against operation at excessive temperatures (charging stopped when battery cell temperature < 0 °C or > 60 °C).

The emergency lighting LED Driver will recharge the battery normally after running the test of 61347-2-7 CL 22.3 (abnormal operating conditions).

^② The battery will not be charged below 2.0 V.

6.3 Accu-LiFePO₄**Capacity 1.5 Ah**

International designation	IFpR 19/66
Battery voltage/cell	3.2 V
Cell type	18650
Case temperature range to ensure	
5 years design life	+5 °C to +60 °C
7 years design life	+5 °C to +55 °C
10 years design life	+5 °C to +45 °C
12 years design life	+5 °C to +35 °C
Max. short term battery case temperature (shorter than 1 month over the battery lifetime)	70 °C
Max. number discharge cycles	50 cycles total
Max. storage time	15 months at -20 °C to +35 °C

6.4 Accupack-LiFePO₄**Capacity 1.5 Ah**

International designation	IFpR 19/66
Battery voltage/cell	3.2 V
Cell type	18650
Case temperature range to ensure	
4 years design life	+5 °C to +45 °C
6 years design life	+5 °C to +35 °C
8 years design life	+5 °C to +25 °C
Max. short term temperature (reduced lifetime)	45 °C
Max. number discharge cycles	50 cycles total
Max. storage time	15 months at -20 °C to +35 °C

Comply with UN 38.3 and IEC 62133 (safety testing) protected against over charge, over discharge, charging at excessive temperatures, short-circuit and over current.

Only use Tridonic batteries.

6.5 Accu / Accupack-LiFePO₄**Capacity 3.3 Ah**

International designation	IFpR 27/66
Battery voltage/cell	3.2 V
Cell type	26650
Case temperature range to ensure	
4 years design life	+5 °C to +45 °C
6 years design life	+5 °C to +35 °C
8 years design life	+5 °C to +25 °C
Max short term battery case tc point temperature (reduced lifetime)	70 °C
Max. number discharge cycles	50 cycles total
Max. storage time	15 months at -20 °C to +35 °C

6.6 Safety

Note: LiFeGuard ensures safe and reliable battery operation by offering a comprehensive three-layered safety system. It addresses the cell, battery pack and emergency driver.

6.6.1 Deep discharge protection

When the battery remains connected without charging for a long period of time after the battery cut off of the driver the battery voltage can still drop. To make sure the cells are not damaged by this voltage drop, the battery protection prevents the battery from further discharge below 2.0 V.

6.6.2 Overcharge protection

If in case of an error or the use of a wrong driver the battery gets overcharged the battery protection will disconnect the battery from the driver at a voltage of 3.9 V. A discharge of the battery is still possible after the protection circuit was triggered to guarantee emergency operation.

6.6.3 Short-circuit protection

In case of a short circuit the battery protection opens the connection to the driver and the output is therefore free of voltage. The output will be reactivated again when the short circuit is removed.

6.6.4 Temperature protection

The battery is protected against temporary thermal overheating. If the temperature limit is exceeded the further charging of the battery is no longer possible. The temperature protection is activated below approx. 0 °C and above approx. +60 °C. The discharging of the battery is still possible to guarantee emergency operation. The charging is automatically activated when the temperature is within the range of 0 to 60°C again.



Battery has built in thermal sensor for safe charging. Mount battery away from heat source. Positioning of the thermal sensor see battery data sheet.

6.7 Wiring batteries

To inhibit inverter operation disconnect the batteries by removing the connection at battery side.

For further informations refer to corresponding battery datasheet.

6.8 Storage, installation and commissioning

Relevant information about storage conditions, installation and commissioning are provided in the battery datasheets.

7. Miscellaneous

7.1 Battery replacement

After a battery replacement and a subsequent full charge cycle (24 h) a duration test is mandatory to prove that with the new battery the rated duration is achieved.

7.2 Mains-connected transformers

The EM powerLED does not contain mains-connected windings of transformers.

7.3 FELV control terminals



FELV control terminals marked „Risk of electric shock“ are not safe to touch. Insulate circuits connected to any FELV control terminal for the Low Voltage supply voltage of the control gear. Protect terminals connected to the FELV circuit against accidental contact.

7.4 Additional information

Additional technical information at www.tridonic.com → Technical Data

Guarantee conditions at www.tridonic.com → Services

Lifetime declarations are informative and represent no warranty claim.
No warranty if device was opened.