

EM powerLED BASIC 1 – 2 W

Combined emergency lighting LED driver 1 – 4 W

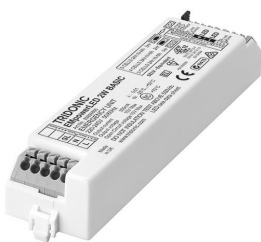

Screw-fix



Clip-fix

Product description

- _ Emergency lighting LED driver for manual testing
- _ For self-contained emergency lighting
- _ SELV for output voltage < 60 V DC
- _ Low profile casing (21 x 30 mm cross-section)
- _ EM = Emergency
- _ 5 years guarantee (conditions at <https://www.tridonic.com/en/int/services/manufacturer-guarantee-conditions>)

Properties

- _ Mains and emergency operation
- _ Constant current mode
- _ With either screw or clip fastening (clip-fix)
- _ 1, 2 or 3 h rated duration
- _ Selectable operating time (jumper)
- _ Green charge status display LED
- _ Output power limitation
- _ Automatic restart after LED replacement
- _ Electronic multi-level charge system
- _ SELV classified (outputs powerLED, battery, status LED, test switch)
- _ Polarity reversal protection for battery
- _ Deep discharge protection
- _ Very low energy consumption from the battery after activation of the deep discharge protection
- _ Short-circuit-proof battery connection
- _ Emergency lighting LEDs available

Batteries

- _ High-temperature cells 2 Ah
- _ NiMH batteries
- _ Cs cells
- _ NiMH: 4 years design life / 2 years guarantee (conditions at <https://www.tridonic.com/en/int/services/manufacturer-guarantee-conditions>)
- _ For battery compatibility refer to data sheet

Website

<http://www.tridonic.com/89899858>



EM powerLED BASIC 1 – 2 W

Combined emergency lighting LED driver 1 – 4 W

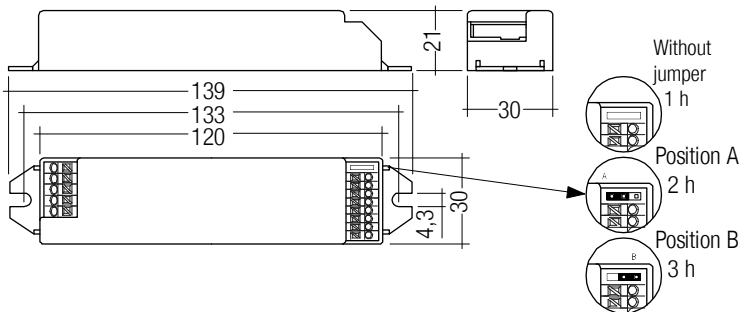

Screw-fix

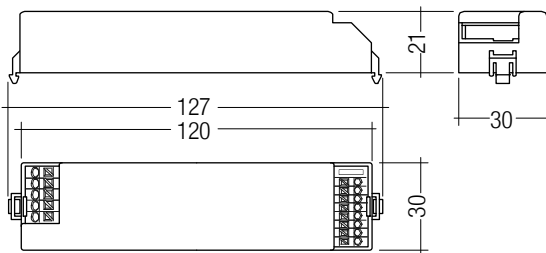

Clip-fix

Ordering data

Type	Article number	Dimensions L x W x H	Rated duration	Max. number of LEDs	Packaging, carton	Packaging, pallet	Weight per pc.
Screw fastening version							
EM powerLED 1 W BASIC SCREW-FIX	89899858	139 x 30 x 21 mm	1/2/3 h	1	25 pc(s).	1,200 pc(s).	0.056 kg
EM powerLED 2 W BASIC SCREW-FIX	89899859	139 x 30 x 21 mm	1/2/3 h	2	25 pc(s).	1,200 pc(s).	0.056 kg
Clip fastening version							
EM powerLED 1 W BASIC CLIP-FIX	89899865	127 x 30 x 21 mm	1/2/3 h	1	25 pc(s).	1,200 pc(s).	0.056 kg
EM powerLED 2 W BASIC CLIP-FIX	89899866	127 x 30 x 21 mm	1/2/3 h	2	25 pc(s).	1,200 pc(s).	0.056 kg

Technical data

Rated supply voltage	220 – 240 V
Mains frequency	50 / 60 Hz
Forward voltage range LED module (1 x LED)	2.8 – 3.4 V
Forward voltage range LED module (2 x LED)	5.6 – 6.8 V
Max. open circuit voltage	10 V
Mains current, 1 W device	30 mA
Mains current, 2 W device	40 mA
Power in mains operation, 1 W device	3.5 W
Power in mains operation, 2 W device	5 W
Starting time	0.31 s from detection of emergency event
Overvoltage protection	320 V (for 1 h)
Battery discharge current	Refer to data sheet
Max. casing temperature tc	70 °C
Ambient temperature ta	-25 ... +50 °C
Mains voltage changeover threshold	According to EN 60598-2-22
Type of protection	IP20
Lifetime	up to 50,000 h
Guarantee (conditions at www.tridonic.com)	5 Year(s)

Approval marks



Standards

according to EN 50172, according to EN 60598-2-22, EN 61347-2-7, EN 61347-2-13, EN 62384, EN 55015, EN 61000-3-2, EN 61547, EN 60068-2-64, EN 60068-2-29, EN 60068-2-30

Specific technical data

Type	Rated duration	Typ. λ (at 230 V, 50 Hz) ^①	Typ. output power	Mains current in charging operation			Mains power in charging operation		
				Initial charge	Fast recharge	Trickle charge	Initial charge	Fast recharge	Trickle charge
EM powerLED 1 W BASIC SCREW-FIX	1 h	0.52C	1 W	15.4 mA	17.9 mA	13.9 mA	1.3 W	1.6 W	1.1 W
EM powerLED 1 W BASIC SCREW-FIX	2 h	0.52C	1 W	14.2 mA	17.6 mA	11.8 mA	1.1 W	1.6 W	0.8 W
EM powerLED 1 W BASIC SCREW-FIX	3 h	0.52C	1 W	14.2 mA	17.6 mA	11.8 mA	1.1 W	1.6 W	0.8 W
EM powerLED 2 W BASIC SCREW-FIX	1 h	0.55C	2 W	14.3 mA	17.3 mA	11.7 mA	1.1 W	1.6 W	0.8 W
EM powerLED 2 W BASIC SCREW-FIX	2 h	0.55C	2 W	15.7 mA	20.4 mA	12.8 mA	1.4 W	2.0 W	0.9 W
EM powerLED 2 W BASIC SCREW-FIX	3 h	0.55C	2 W	18.4 mA	23.3 mA	14.5 mA	1.7 W	2.4 W	1.2 W
EM powerLED 1 W BASIC CLIP-FIX	1 h	0.52C	1 W	15.4 mA	17.9 mA	13.9 mA	1.3 W	1.6 W	1.1 W
EM powerLED 1 W BASIC CLIP-FIX	2 h	0.52C	1 W	14.2 mA	17.6 mA	11.8 mA	1.1 W	1.6 W	0.8 W
EM powerLED 1 W BASIC CLIP-FIX	3 h	0.52C	1 W	14.2 mA	17.6 mA	11.8 mA	1.1 W	1.6 W	0.8 W
EM powerLED 2 W BASIC CLIP-FIX	1 h	0.55C	2 W	14.3 mA	17.3 mA	11.7 mA	1.1 W	1.6 W	0.8 W
EM powerLED 2 W BASIC CLIP-FIX	2 h	0.55C	2 W	15.7 mA	20.4 mA	12.8 mA	1.4 W	2.0 W	0.9 W
EM powerLED 2 W BASIC CLIP-FIX	3 h	0.55C	2 W	18.4 mA	23.3 mA	14.5 mA	1.7 W	2.4 W	1.2 W

① Maintained operation

Test switch EM2

Accessory



Product description

- _ For connection to the emergency lighting unit
- _ For checking the device function
- _ Dielectric strength: 1,500 V AC for 60 seconds
- _ Lead length 0.55m
- _ Mounting hole 7,0 mm diameter

Website

<http://www.tridonic.com/89805277>



Ordering data

Type	Article number	Packaging, bag	Packaging, carton	Weight per pc.
Test switch EM 2	89805277	25 pc(s).	1,800 pc(s).	0.009 kg

Approval marks

RoHS

Status indication green LED EM

Accessory



Product description

- _ A green LED indicates that charging current is flowing into the battery

Website

<http://www.tridonic.com/89899605>



Ordering data

Type	Article number	Packaging, bag	Packaging, carton	Weight per pc.
LED EM green	89899605	25 pc(s).	200 pc(s).	0.013 kg
LED EM green, ultra high brightness	89899756	25 pc(s).	200 pc(s).	0.013 kg

Approval marks

RoHS

EMpLED Strain-relief set 200x43x25.5mm

Accessory



Product description

- _ Optional strain-relief for independent applications
- _ Transforms the LED driver into a fully class II compatible LED driver (e.g. ceiling installation)
- _ Easy and tool-free mounting to the LED driver, screwless cable-clamp channels with strain-relief (200 x 43 x 25.5 mm)

Website

<http://www.tridonic.com/28004033>



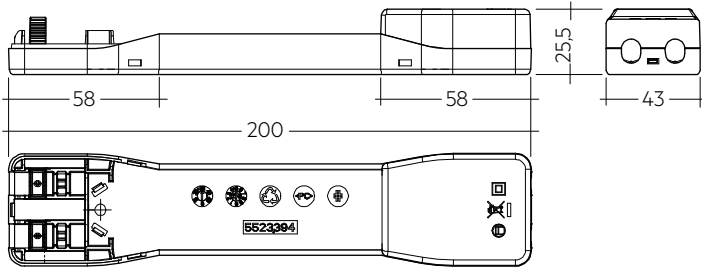

Permissible cable jacket diameter 2.2 – 9 mm

Ordering data

Type	Article number	Packaging, carton	Weight per pc.
EM pLED SR	28004033	10 pc(s).	0.05 kg

Approval marks



Standards

- EN 61347-2-7
- EN 61347-2-13
- EN 62384
- EN 55015
- EN 61000-2-3
- EN 61547
- EN 60068-2-64
- EN 60068-2-29
- EN 60068-2-30
- according to EN 50172
- according to EN 60598-2-22

1.1 Glow-wire test

according to EN 61347-1 with increased temperature of 850 °C passed.

1.2 Insulation and electric strength testing of luminaires

Electronic LED drivers can be damaged by high voltage. This has to be considered during the routine testing of the luminaires in production.

According to IEC 60598-1 Annex Q (informative only!) or ENEC 303-Annex A, each luminaire should be submitted to an insulation test with 500 Vdc for 1 second. This test voltage should be connected between the interconnected phase and neutral terminals and the earth terminal. The insulation resistance must be at least 2 MΩ.

As an alternative, IEC 60598-1 Annex Q describes a test of the electrical strength with 1,500 V_{AC} (or 1,414 x 1,500 V_{DC}). To avoid damage to the electronic LED drivers this test must not be conducted.

2. Thermal details and lifetime

2.1 Lifetime

Average lifetime 50,000 hours under rated conditions with a failure rate of less than 10 %. Average failure rate of 0.2 % per 1000 operating hours.

3. Installation / Wiring

3.1 Wiring diagrams

3.1.1 Serial wiring with one or two LED modules

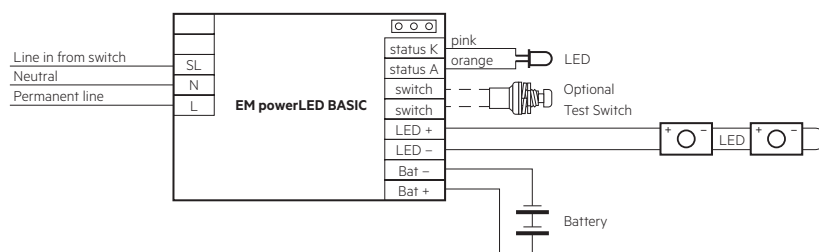

3.1.2 Parallel wiring with multiple LED modules (3 - 12)

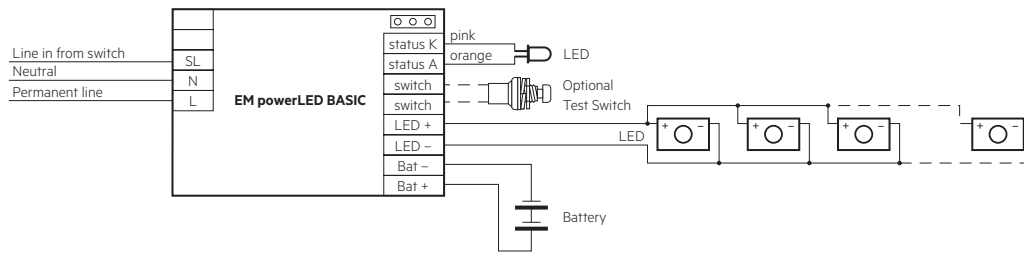

Take care that the LED is connected with the right polarity. LED that are connected to the EM powerLED devices should have a reverse polarity protection device such as a schottky diodes fitted, otherwise irreversible damage could occur if the LED is connected in reverse polarity. Any protection device must be capable of handling in excess of 700 mA.

Note: Please ensure that at the terminal of the EM powerLED module the battery negative is not connected to the negative of the LED load.

3.1.3 Manually tested emergency lighting with combined LED modules for general and emergency lighting

Due to the fact that independent circuits are used for general and emergency lighting it is important that the normal supply of the mains LED driver is switched off together with the permanent emergency supply prior to checking the operation of the emergency LEDs.

If this is not done then it may not be possible to see that the emergency LEDs are operating.

Use a circuit similar to that shown next.

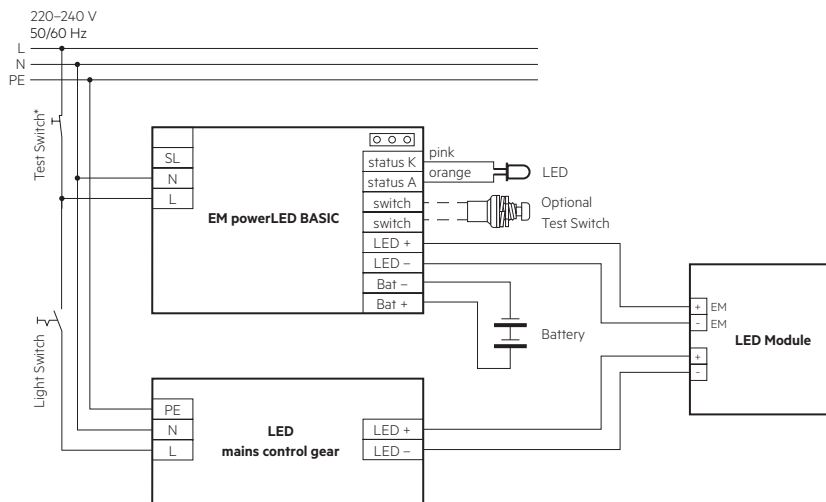

* Use 230 V Test switch

3.1.4 Simple CORRIDOR FUNCTION with EM powerLED 1-2 W

With the mains operation function of the EM powerLED 1-2 W a simple corridor function can be realised.

An external presence detector switches the mains LED driver.

The EM powerLED 1-2 W has the switched line SL connected to permanent mains supply.

On presence both mains LED driver and EM powerLED 1-2 W are active and driving all LEDs. With no presence the mains LED driver is switched off by the presence detector and the EM powerLED 1-2 W stays on operating the emergency LEDs at low power.

Use a circuit similar to that shown next.

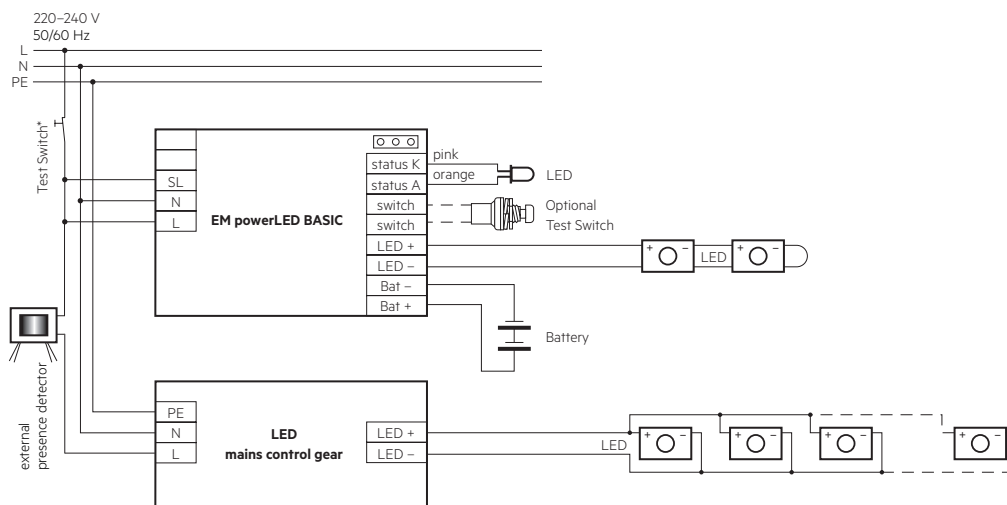

3.2 Wiring type and cross section

Wiring

mains (SL, N, L)
LED (LED +, LED -)

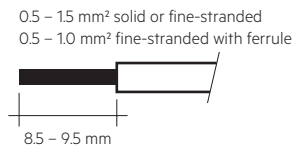

Wiring

batteries (Bat +, Bat -)
test switch (switch)
status indication LED (status K, A)

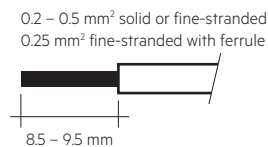

Use one wire for each terminal connector only.

3.3 Release of the wiring

Press down the "push button" and remove the cable from front.

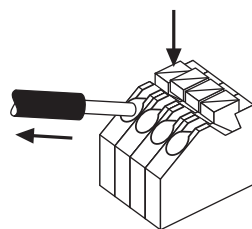

3.4 Wiring instructions

- The EM powerLED terminals, battery, indicator LED and test switch terminals are classified as SELV. Keep the wiring of the DALI and the input terminals separated from the wiring of the SELV terminals or consider special wiring (double insulation, 6 mm creepage and clearance) when these connections should be kept SELV.
- The output to the LED is DC but has high frequency content at 125 kHz, which should be considered for good EMC compliance.
- EM powerLED leads should be separated from the mains and DALI connections and wiring for good EMC performance.
- Maximum lead length on the EM powerLED terminals is 3 m. For a good EMC performance keep the LED wiring as short as possible.
- The secondary wires (LED module) should be routed in parallel to ensure good EMC performance.
- Maximum lead length for the test switch and Indicator LED connection is 1 m. The test switch and Indicator LED wiring should be separated from the EM powerLED leads to prevent noise coupling.
- Battery leads are specified with 0.5 mm² cross section and a length of < 1.3 m.
- Switched live and unswitched live supplies must be off the same phase.
- To avoid the damage of the control gear, the wiring must be protected against short circuits to earth (sharp edged metal parts, metal cable clips, louver, etc.).

3.5 Max. lead insulation diameter

Battery	2.1 mm
Test switch	2.1 mm
Indicator LED	2.1 mm

3.6 Maximum lead length

LED	3 m
Status indication LED	1 m
Batteries	1 m

4. Mechanical details

Case manufactured from polycarbonate.

LED status indicator

- Green
- Mounting hole 6.5 mm diameter, 1 – 1.6 mm thickness
- Lead length 1000 mm

Test switch

- Mounting hole 7.0 mm diameter
- Lead length 550 mm

Battery leads

- Quantity: 1 red and 1 black
- Length: 1 m
- Wire type: 0.5 mm² solid conductor
- Insulation rating: 90 °C

Battery end termination

Push on 4.8 mm receptacle to suit battery spade fitted with insulating cover

Module end termination

8.0 mm stripped insulation

Two-piece batteries are supplied with a 200 mm lead with 4.8 mm receptacles at each end and insulating covers to connect the separate sticks together.

4.1 Recommended fixing details for clip fixing

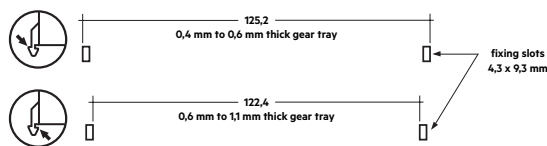

Max. torque at the clamping screw: 0.5 Nm / M4

5. Electrical values

5.1 Maximum loading of automatic circuit breakers

Automatic circuit breaker type	B10	C10	B13	C13	B16	C16	B20	C20	Inrush current	
Installation Ø	15 mm ²	15 mm ²	15 mm ²	15 mm ²	2.5 mm ²	2.5 mm ²	2.5 mm ²	2.5 mm ²	I _{max}	time
EM powerLED 1 W BASIC	90	180	130	260	130	260	130	260	10 A	120 µs
EM powerLED 2 W BASIC	90	180	130	260	130	260	130	260	10 A	120 µs

5.2 Insulation matrix

	Mains	Switched Live	Battery, LED, Test switch, Indicator LED
Mains	–	•	••
Switched Live	•	–	••
Battery, LED, Test switch, Indicator LED	••	••	–

- Represents basic insulation
- Represents double or reinforced insulation

5.3 Typ. LED current

EM powerLED 1-2 W BASIC, 1 / 2 / 3 h

Type	EM powerLED 1 W BASIC	EM powerLED 2 W BASIC
Article no.	89899858, 89899865	89899859, 89899866
LED current in emergency operation		
1 x LED	350 mA	600 mA
2 x LED	–	350 mA
LED current in mains operation		
1 x LED	350 mA	350 mA
2 x LED	–	350 mA



6. Emergency output factor EOFi

EM powerLED 1-2 W BASIC, 1 / 2 / 3 h

Type	EM powerLED 1 W BASIC	EM powerLED 2 W BASIC
Article no.	89899858, 89899865	89899859, 89899866
Cells	2 / 3 cells	3 / 4 / 5 cells
LED current	LED load	LED load
350 mA	100 %	100 %
350 mA	100 %	100 %
350 mA	100 %	100 %
600 mA	–	170 %
600 mA	–	170 %
600 mA	–	170 %

7. Functions

7.1 Duration link selection

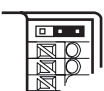
Duration	Link Position
1 hr	 without jumper
2 hr	 position A
3 hr	 position B

7.2 Jumper selection

Module supplied with jumper in 3 hours position (position B).

The position of the link will only be read on first power up. If it is changed afterwards both the battery and mains supply must be disconnected for 10 seconds to enable the EM powerLED to read the new link position on reconnection of the battery and mains. It will lead to a false battery failure indication if the link is changed after installation without this reset.

7.3 Further technical data

The EM powerLED has a unique power regulation circuit; this is designed to limit the total power drawn from the battery in the event of using LED's with a forward voltage (Vf) higher than 3.4 V.

In such cases the unit will reduce the LED current in order to maintain an acceptable drain current from the battery and hence meet the required duration time. This feature enables the EM powerLED to have minimum battery count for a given range of LED's.

At a low charge state of the battery (<1.5V at the 1W driver and <3V at the 2W driver) the LED will not be driven in maintained mode via the switched line until the rated battery voltage levels are exceeded.

8. Battery data

8.1 Battery selection

EM powerLED 1-2 W BASIC, 1 / 2 / 3 h

		Type	EM powerLED 1 W BASIC			EM powerLED 2 W BASIC		
		Article no.	89899858, 89899865			89899859, 89899866		
		Duration	1 h	2 h	3 h	1 h	2 h	3 h
		Cells	2 cells	3 cells	3 cells	3 cells	4 cells	5 cells
Technology and capacity	Design	Number of cells	Type	Article no.	Assignable batteries			
NiMH 2.2Ah Cs cells	stick	1 x 2	Accu-NiMH 2A	28002087	•			
	stick	1 x 3	Accu-NiMH 3A	28002088		•	•	
	stick	1 x 4	Accu-NiMH 4A	28002089				•
	stick	1 x 5	Accu-NiMH 5A	28002090				•
	side by side	5 x 1	Accu-NiMH 5B	28002093				•

8.2 Battery charge / discharge data

EM powerLED 1-2 W BASIC, 1 / 2 / 3 h

		Type	EM powerLED 1 W BASIC			EM powerLED 2 W BASIC		
		Article no.	89899858, 89899865			89899859, 89899866		
		Duration	1 h	2 h	3 h	1 h	2 h	3 h
		Cells	2 cells	3 cells	3 cells	3 cells	4 cells	5 cells
Battery charge time	Initial charge	20 h						
	Fast recharge	12 h						
	Trickle charge	continuously (pulse charge)						
Charge current	Initial charge	130 mA						
	Fast recharge	210 mA						
	Trickle charge	130 mA / 0 mA (4 min. / 16 min.)						
Discharge current	1 x LED	770 mA	460 mA	460 mA	900 mA	640 mA	500 mA	
	2 x LED	–	–	–	870 mA	630 mA	500 mA	
Charge voltage range ^①		1.07 – 1.6 V per cell						
Discharge voltage range		1.6 – 1.07 V per cell						

^① The battery will be charged below 1.07 V. The EM powerLED will indicate a battery fault.
The emergency lighting LED driver will recharge the battery normally after running the test of 61347-2-7 CL 22.3 (abnormal operating conditions).

8.3 Accu-NiMH 2.2 Ah

Battery voltage/cell	1.2 V
Cell type	Cs
Case temperature range to ensure 4 years design life	+5 °C to +55 °C
Max. short term battery case temperature (shorter than 1 month over the battery lifetime)	70 °C
Max. number discharge cycles	4 cycles per year plus 30 cycles during commissioning
Max. storage time	12 months

8.4 Accupack-NiMH 2.2 Ah

Battery voltage/cell	1.2 V
Cell type	Cs
Ambient temperature range to ensure 4 years design life	+5 °C to +35 °C
tc point	+40 °C
Max. short term battery case temperature (shorter than 1 month over the battery lifetime)	70 °C
Max. number discharge cycles	4 cycles per year plus 4 cycles during commissioning
Max. storage time	12 months

8.5 Batteries

Connection method: 4.8 x 0.5 mm spade tag welded to end of cell

For stick packs this connection is accessible after the battery caps have been fitted.

To inhibit inverter operation disconnect the batteries by removing the connector from the battery spade tag.

For further information refer to corresponding battery datasheet.

8.6 Short-circuit protection

In case of a short circuit the battery protection opens the connection to the driver and the output is therefore free of voltage. The output will be reactivated again when the short circuit is removed.

8.7 Storage, installation and commissioning

Relevant information about storage conditions, installation and commissioning are provided in the battery datasheets.

9. Miscellaneous**9.1 Mains-connected transformers**

The EM powerLED does not contain mains-connected windings of transformers.

9.2 Additional information

Additional technical information at www.tridonic.com → Technical Data

Lifetime declarations are informative and represent no warranty claim.
No warranty if device was opened.