

**EM converterLED PRO NFC MH/LiFePO4 250 V**

Powered DALI PRO NFC version



LiFeGuard

**Product description**

- \_ Self-contained emergency lighting LED driver with DALI interface and automatic test function
- \_ For LED modules with a forward voltage of 48 – 250 V
- \_ For luminaire installation
- \_ EM = Emergency
- \_ Nominal lifetime up to 100,000 h
- \_ 5 years guarantee (conditions at <https://www.tridonic.com/en/int/services/manufacturer-guarantee-conditions>)

**Functions**

- \_ Non maintained operation
- \_ Integrated DALI bus power supply
- \_ 1, 2 or 3 h rated duration selectable with duration link
- \_ Compatible with most constant current LED drivers (see data sheet, LED driver compatibility)
- \_ 3-pole technology: 2-pole LED module changeover and delayed power switching for the LED driver
- \_ Constant power output
- \_ Two-colour status display LED
- \_ Black Box data recording

**Interfaces**

- \_ DALI interface for controlled testing and monitoring
- \_ Near field communication (NFC)

**Battery management**

- NiMH/LiFePO4:
  - \_ Intelligent charge system
  - \_ Deep discharge protection
  - \_ Polarity reversal protection for battery via polarised connector plug
  - \_ Automatic detection of the connected battery technology (NiMH or LiFePO4 batteries)
- LiFePO4:
  - \_ Tridonic LiFeGuard ensures safety in use (refer to data sheet, Safety LiFePO4)
  - \_ Temperature protection

**Batteries**

- \_ NiMH or LiFePO4 batteries
- \_ NiMH: 4 years design life / 2 years guarantee (conditions at <https://www.tridonic.com/en/int/services/manufacturer-guarantee-conditions>)
- \_ LiFePO4: up to 12 years design life
- \_ 8 years guarantee for LiFePO4 batteries (conditions at <https://www.tridonic.com/en/int/services/manufacturer-guarantee-conditions>)<sup>①</sup>
- \_ LiFePO4 batteries with Tridonic LiFeGuard
- \_ For battery compatibility refer to data sheet, battery selection

① 28005859 - 5-year guarantee.

**Website**<http://www.tridonic.com/89800643>

**EM converterLED PRO NFC MH/LiFePO4 250 V**

Powered DALI PRO NFC version

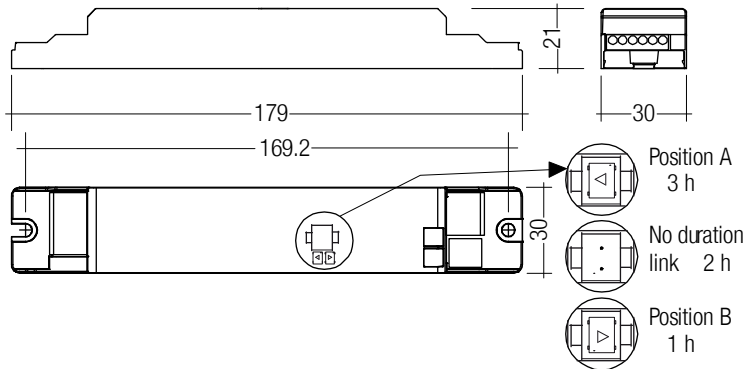

Note: Supply of control gear with duration link in 3 hours position. Duration link must be set before battery and mains connection.

**Ordering data**

Type	Article number	Rated duration	Packaging, carton	Packaging, pallet	Weight per pc.	Dimensions L x W x H
EM converterLED PRO 303 MH/LiFePO4 250V	89800643	1/2/3 h	10 pc(s).	1,600 pc(s).	0.075 kg	179 x 30 x 21 mm
EM converterLED PRO 304 MH/LiFePO4 250V	89800644	1/2/3 h	10 pc(s).	1,600 pc(s).	0.075 kg	179 x 30 x 21 mm
EM converterLED PRO 305 MH/LiFePO4 250V	89800645	1/2/3 h	10 pc(s).	1,600 pc(s).	0.075 kg	179 x 30 x 21 mm

**Technical data**

Rated supply voltage	220 – 240 V
AC voltage range	198 – 264 V
Mains frequency	50 / 60 Hz
Forward voltage range LED module	48 – 250 V
Output current	Refer to data sheet
Starting time	< 0.5 s from detection of emergency event
Overvoltage protection	320 V (for 48 h)
U-OUT (including open- / short-circuit and double load)	300 V
Max. open circuit voltage	300 V
Ambient temperature ta	-25 ... +55 °C
Max. casing temperature tc	80 °C
Mains voltage changeover threshold	According to EN 60598-2-22
Mains surge capability (between L - N)	1 kV
Mains surge capability (between L/N - PE)	2 kV
Integrated DALI bus power supply IPS	50 mA
Type of protection	IP20
Functional test	Weekly 5s test
Duration test	Yearly 1 h / 2 h / 3 h test
Lifetime	up to 100,000 h
Guarantee (conditions at www.tridonic.com)	5 Year(s)
Dimensions L x W x H	179 x 30 x 21 mm

**Approval marks**



**Standards**

EN 61347-1, EN 61347-2-13, EN 61347-2-7, EN 55015, EN 61000-3-2, EN 61000-3-3, EN 61547, EN 60068-2-64, EN 60068-2-29, EN 60068-2-30, EN 62384, EN 62386-101, EN 62386-102, EN 62386-202, according to EN 50172, according to EN 60598-2-22, acc. to EN 62034

Specific technical data

Type	Battery technology	Rated duration	Typ. $\lambda$ (at 230 V, 50 Hz)	Typ. output power P emergency	Mains current in charging operation			Mains power in charging operation		
					Initial charge <sup>②</sup>	Fast recharge <sup>②</sup>	Trickle charge <sup>②</sup>	Initial charge <sup>②</sup>	Fast recharge <sup>②</sup>	Trickle charge <sup>②</sup>
EM converterLED PRO 303 MH/LiFePO4 250V	NiMH	1 h	0.6C	2.5 W	17 mA	20 mA	17 / 12 mA	2.3 W	2.8 W	2.3 / 1.6 W
EM converterLED PRO 303 MH/LiFePO4 250V	NiMH	2 h	0.6C	2.5 W	24 mA	25 mA	20 / 12 mA	3.2 W	3.4 W	2.7 / 1.6 W
EM converterLED PRO 303 MH/LiFePO4 250V	NiMH	3 h	0.6C	2.5 W	24 mA	25 mA	20 / 12 mA	3.2 W	3.4 W	2.7 / 1.6 W
EM converterLED PRO 303 MH/LiFePO4 250V	LiFePO4	1 h	0.6C	3.3 W	22 mA	22 mA	22 / 12 mA	3.0 W	3.0 W	3.0 / 1.6 W
EM converterLED PRO 303 MH/LiFePO4 250V	LiFePO4	2 h	0.6C	3.3 W	27 mA	27 mA	27 / 12 mA	4.0 W	4.0 W	4.0 / 1.6 W
EM converterLED PRO 303 MH/LiFePO4 250V	LiFePO4	3 h	0.6C	3.3 W	27 mA	27 mA	27 / 12 mA	4.0 W	4.0 W	4.0 / 1.6 W
EM converterLED PRO 304 MH/LiFePO4 250V	NiMH	1 h	0.6C	3.5 W	18 mA	22 mA	18 / 12 mA	2.5 W	3.1 W	2.5 / 1.6 W
EM converterLED PRO 304 MH/LiFePO4 250V	NiMH	2 h	0.6C	3.5 W	26 mA	27 mA	22 / 12 mA	3.8 W	4.1 W	3.0 / 1.6 W
EM converterLED PRO 304 MH/LiFePO4 250V	NiMH	3 h	0.6C	3.5 W	26 mA	27 mA	22 / 12 mA	3.8 W	4.1 W	3.0 / 1.6 W
EM converterLED PRO 304 MH/LiFePO4 250V	LiFePO4	1 h	0.6C	4.0 W	22 mA	22 mA	22 / 12 mA	3.0 W	3.0 W	3.0 / 1.6 W
EM converterLED PRO 304 MH/LiFePO4 250V	LiFePO4	2 h	0.6C	4.0 W	27 mA	27 mA	27 / 12 mA	4.0 W	4.0 W	4.0 / 1.6 W
EM converterLED PRO 304 MH/LiFePO4 250V	LiFePO4	3 h	0.6C	4.0 W	27 mA	27 mA	27 / 12 mA	4.0 W	4.0 W	4.0 / 1.6 W
EM converterLED PRO 305 MH/LiFePO4 250V	NiMH	1 h	0.6C	4.5 W	20 mA	24 mA	20 / 12 mA	2.8 W	3.5 W	2.8 / 1.6 W
EM converterLED PRO 305 MH/LiFePO4 250V	NiMH	2 h	0.6C	4.5 W	28 mA	30 mA	24 / 12 mA	4.4 W	4.7 W	3.3 / 1.6 W
EM converterLED PRO 305 MH/LiFePO4 250V	NiMH	3 h	0.6C	4.5 W	28 mA	30 mA	24 / 12 mA	4.4 W	4.7 W	3.3 / 1.6 W
EM converterLED PRO 305 MH/LiFePO4 250V	LiFePO4	1 h	0.6C	4.5 W	22 mA	22 mA	22 / 12 mA	3.0 W	3.0 W	3.0 / 1.6 W
EM converterLED PRO 305 MH/LiFePO4 250V	LiFePO4	2 h	0.6C	4.5 W	27 mA	27 mA	27 / 12 mA	4.0 W	4.0 W	4.0 / 1.6 W
EM converterLED PRO 305 MH/LiFePO4 250V	LiFePO4	3 h	0.6C	4.5 W	27 mA	27 mA	27 / 12 mA	4.0 W	4.0 W	4.0 / 1.6 W

② Integrated DALI bus power supply is switched OFF. With the Integrated DALI bus power supply switched ON and fully loaded the input power and current is increased by 1 W and 6 mA in any charging mode.  
 ③ In case of NiMH batteries: Intermittent charge is used. Value 1 is for 4 min. charge on / Value 2 is for 16 min. charge off. In case of LiFePO4 batteries voltage dependent constant current charging is used. Value 1 is for charge on / Value 2 is for charge off.

EMcLED Strain-relief set 240x43x30mm

Accessory



**Product description**

- \_ Optional strain-relief for independent applications
- \_ Transforms the LED driver into a fully class II compatible LED driver (e.g. ceiling installation)
- \_ Easy and tool-free mounting to the LED driver, screwless cable-clamp channels with strain-relief (240 x 43 x 30 mm)

**Website**

<http://www.tridonic.com/28003813>



## Emergency lighting units

EM converterLED

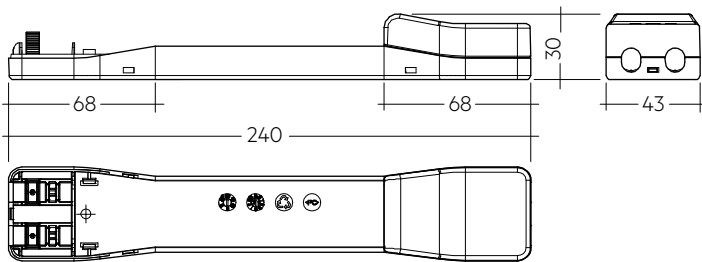

Permissible cable jacket diameter 2.2 – 9 mm

### Ordering data

Type	Article number	Packaging, carton	Weight per pc.
EM cLED SR	28003813	10 pc(s).	0.08 kg

### Approval marks



## Test switch EM3

Accessory



### Product description

- \_ For connection to the emergency lighting unit
- \_ For checking the device function
- \_ Plug connection
- \_ Dielectric strength: 1,500 V AC for 60 seconds
- \_ Lead length 0.55m
- \_ Mounting hole 7,0 mm diameter

### Website

<http://www.tridonic.com/89899956>



### Ordering data

Type	Article number	Packaging, bag	Packaging, carton	Weight per pc.
Test switch EM 3	89899956	25 pc(s).	2,000 pc(s).	0.01 kg

### Approval marks



## Status indication bi-colour LED EM CON

Accessory



## Product description

- \_ Two-colour status display LED
- \_ Green: system OK, red: fault
- \_ Plug connection

## Website

<http://www.tridonic.com/89800273>



## Ordering data

Type	Article number	Packaging, bag	Packaging, carton	Weight per pc.
LED EM bi-colour, 1.0 m CON	89800273	25 pc(s).	200 pc(s).	0.016 kg
LED EM bi-colour, high brightness HO 1.0 m CON	89800275	25 pc(s).	200 pc(s).	0.016 kg
LED EM bi-colour, 0.6 m CON	89800474	25 pc(s).	200 pc(s).	0.010 kg
LED EM bi-colour, high brightness HO 0.6 m CON	89800475	25 pc(s).	200 pc(s).	0.011 kg
LED EM bi-colour, 0.3 m CON	89800274	25 pc(s).	200 pc(s).	0.007 kg
LED EM bi-colour, high brightness HO 0.3 m CON	89800276	25 pc(s).	200 pc(s).	0.007 kg

## Connection cable LiFePO4

Accessory



## Product description

- \_ Extension cable for LiFePO4 batteries
- \_ Cable length 500 mm
- \_ 3-pole plug connection

## Website

<http://www.tridonic.com/28002461>



## Ordering data

Type	Article number	Packaging, bag	Packaging, carton	Weight per pc.
EXTENSION CABLE LiFePO4 500mm	28002461	10 pc(s).	200 pc(s).	0.011 kg

Connection cable NiMH

Accessory



**Product description**

- \_ Connection cable for NiMH batteries
- \_ Cable length 500 mm
- \_ 2-pole plug connection for batteries and 3-pole plug connection for LED driver

**Website**

<http://www.tridonic.com/28002462>



**Ordering data**

Type	Article number	Packaging, bag	Packaging, carton	Weight per pc.
CONNECTION CABLE NiMH 500mm	28002462	10 pc(s).	200 pc(s).	0.01 kg

## 1. Standards

- EN 61347-1
- EN 61347-2-13
- EN 61347-2-7
- EN 55015
- EN 61000-3-2
- EN 61000-3-3
- EN 61547
- EN 60068-2-64
- EN 60068-2-29
- EN 60068-2-30
- EN 62384
- EN 62386-101 (DALI-2), only IPS relevant requirements
- EN 62386-102 (DALI-2), only IPS relevant requirements
- EN 62386-202
- according to EN 50172
- according to EN 60598-2-22
- according to EN 62034

Meaning of marking (C)

Double or reinforced insulation for built-in electronic LED drivers. The control gear relies upon the luminaire enclosure for protection against accidental contact with live parts.

### 1.1 Glow-wire test

according to EN 61347-1 with increased temperature of 850 °C passed.

### 1.2 Insulation and electric strength testing of luminaires

Electronic LED-Drivers can be damaged by high voltage. This has to be considered during the routine testing of the luminaires in production.

According to IEC 60598-1 Annex Q (informative only!) or ENEC 303-Annex A, each luminaire should be submitted to an insulation test with 500 V<sub>ac</sub> for 1 second. This test voltage should be connected between the interconnected phase and neutral terminals and the earth terminal. The insulation resistance must be at least 2 MΩ.

As an alternative, IEC 60598-1 Annex Q describes a test of the electrical strength with 1,500 V<sub>ac</sub> (or 1,414 x 1,500 V<sub>dc</sub>). To avoid damage to the electronic devices this test **must not be conducted**.

## 2. Thermal details and lifetime

### 2.1 Lifetime

Average lifetime 50,000 hours under rated conditions with a failure rate of less than 10 %. Average failure rate of 0.2 % per 1000 operating hours.

Expected lifetime with NiMH batteries, DALI power supply off

Type	t <sub>a</sub>	40 °C	45 °C	50 °C	55 °C
<b>EM converterLED PRO 303</b>	t <sub>c</sub>	65 °C	70 °C	75 °C	80 °C
<b>MH/LiFePO<sub>4</sub> 250V</b>	lifetime	> 100,000 h	> 100,000 h	80,000 h	56,000 h
<b>EM converterLED PRO 304</b>	t <sub>c</sub>	65 °C	70 °C	75 °C	80 °C
<b>MH/LiFePO<sub>4</sub> 250V</b>	lifetime	> 100,000 h	> 100,000 h	79,000 h	56,000 h
<b>EM converterLED PRO 305</b>	t <sub>c</sub>	65 °C	70 °C	75 °C	80 °C
<b>MH/LiFePO<sub>4</sub> 250V</b>	lifetime	> 100,000 h	> 100,000 h	78,000 h	55,000 h

Expected lifetime with NiMH batteries, DALI power supply on, load 50 mA

Type	t <sub>a</sub>	40 °C	45 °C	50 °C	55 °C
<b>EM converterLED PRO 303</b>	t <sub>c</sub>	65 °C	70 °C	75 °C	80 °C
<b>MH/LiFePO<sub>4</sub> 250V</b>	lifetime	> 100,000 h	> 100,000 h	78,000 h	55,000 h
<b>EM converterLED PRO 304</b>	t <sub>c</sub>	65 °C	70 °C	75 °C	80 °C
<b>MH/LiFePO<sub>4</sub> 250V</b>	lifetime	> 100,000 h	> 100,000 h	76,000 h	53,000 h
<b>EM converterLED PRO 305</b>	t <sub>c</sub>	65 °C	70 °C	75 °C	80 °C
<b>MH/LiFePO<sub>4</sub> 250V</b>	lifetime	> 100,000 h	> 100,000 h	72,000 h	51,000 h

Expected lifetime with LiFePO<sub>4</sub> batteries, DALI power supply off

Type	t <sub>a</sub>	40 °C	45 °C	50 °C	55 °C
<b>EM converterLED PRO 303</b>	t <sub>c</sub>	65 °C	70 °C	75 °C	80 °C
<b>MH/LiFePO<sub>4</sub> 250V</b>	lifetime	> 100,000 h	> 100,000 h	82,000 h	58,000 h
<b>EM converterLED PRO 304</b>	t <sub>c</sub>	65 °C	70 °C	75 °C	80 °C
<b>MH/LiFePO<sub>4</sub> 250V</b>	lifetime	> 100,000 h	> 100,000 h	82,000 h	58,000 h
<b>EM converterLED PRO 305</b>	t <sub>c</sub>	65 °C	70 °C	75 °C	80 °C
<b>MH/LiFePO<sub>4</sub> 250V</b>	lifetime	> 100,000 h	> 100,000 h	82,000 h	58,000 h

Expected lifetime with LiFePO<sub>4</sub> batteries, DALI power supply on, load 50 mA

Type	t <sub>a</sub>	40 °C	45 °C	50 °C	55 °C
<b>EM converterLED PRO 303</b>	t <sub>c</sub>	65 °C	70 °C	75 °C	80 °C
<b>MH/LiFePO<sub>4</sub> 250V</b>	lifetime	> 100,000 h	> 100,000 h	80,000 h	56,000 h
<b>EM converterLED PRO 304</b>	t <sub>c</sub>	65 °C	70 °C	75 °C	80 °C
<b>MH/LiFePO<sub>4</sub> 250V</b>	lifetime	> 100,000 h	> 100,000 h	80,000 h	56,000 h
<b>EM converterLED PRO 305</b>	t <sub>c</sub>	65 °C	70 °C	75 °C	80 °C
<b>MH/LiFePO<sub>4</sub> 250V</b>	lifetime	> 100,000 h	> 100,000 h	79,000 h	56,000 h

The emergency lighting LED driver is designed for a lifetime stated above under reference conditions and with a failure probability of less than 10 %.

The relation of t<sub>c</sub> to t<sub>a</sub> temperature depends also on the luminaire design. If the measured t<sub>c</sub> temperature is approx. 5 K below t<sub>c</sub> max., t<sub>a</sub> temperature should be checked and eventually critical components (e.g. ELCAP) measured. Detailed information on request.

## 3. Installation / Wiring

### 3.1 Wiring diagram

One or more LED modules with a total forward voltage of 48 to 250 V can be connected to the EM converterLED module. These LED module(s), marked with "Emergency" are operated in emergency mode from the associated battery. In normal mains mode all LED modules are operated by the mains LED driver.

**EM converterLED PRO with one LED module for non-maintained emergency operation**

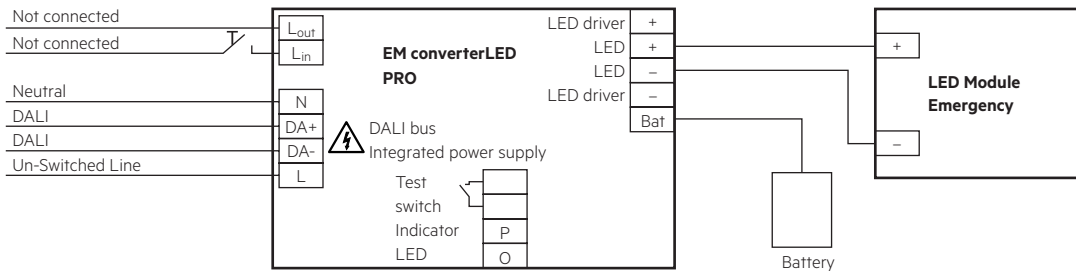

**EM converterLED PRO with a standard LED LED driver and one LED module for mains and emergency operation**

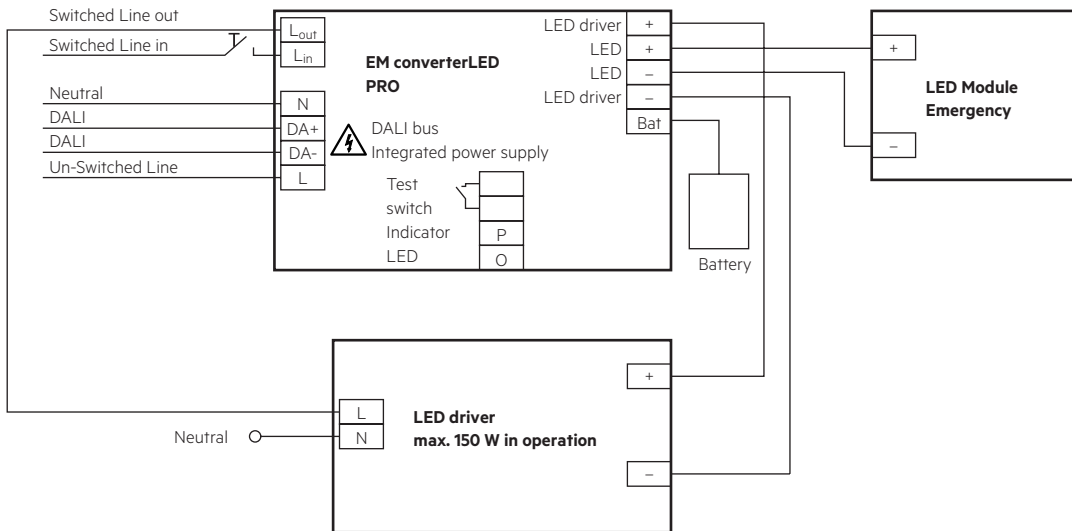

**EM converterLED PRO with a standard LED LED driver and series operation of LED modules**

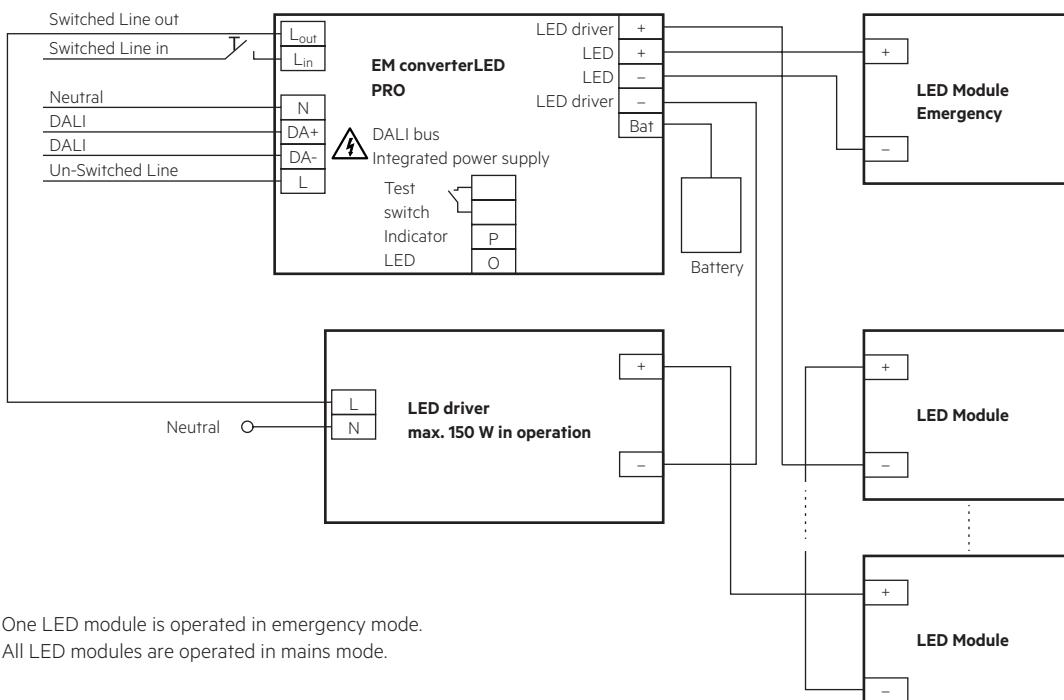

One LED module is operated in emergency mode.  
All LED modules are operated in mains mode.

**EM converterLED PRO with a standard LED driver and parallel operation of LED modules**

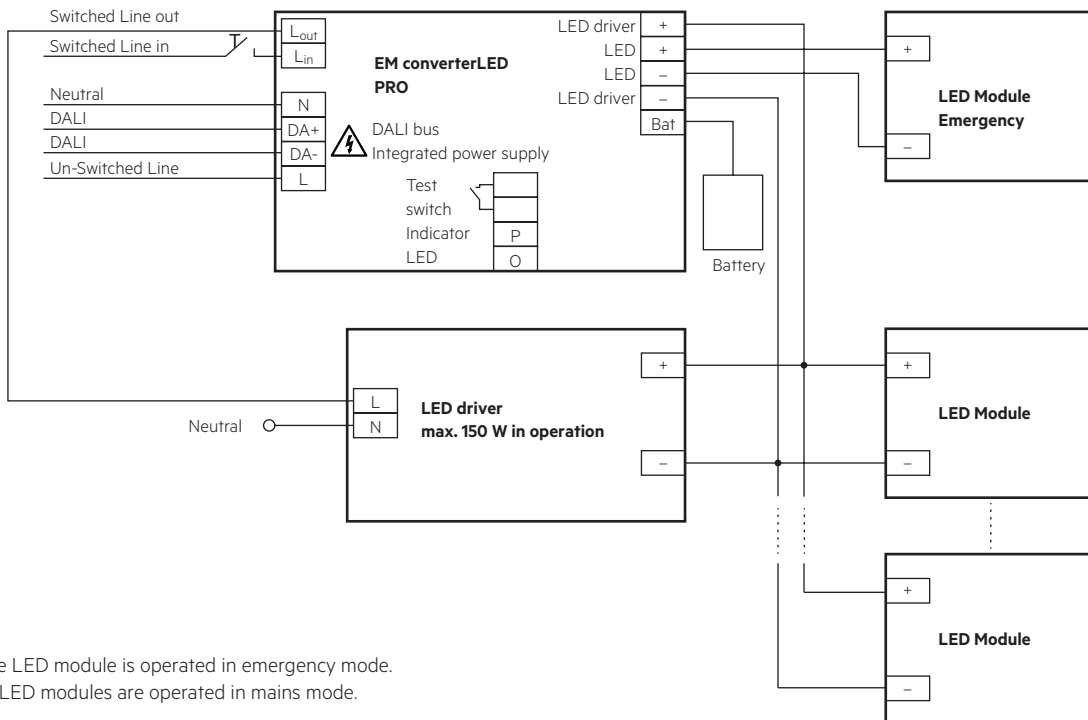

One LED module is operated in emergency mode.  
All LED modules are operated in mains mode.

**Wireless set-up for EM converterLED PRO with a standard LED driver and one LED module for mains and emergency operation**

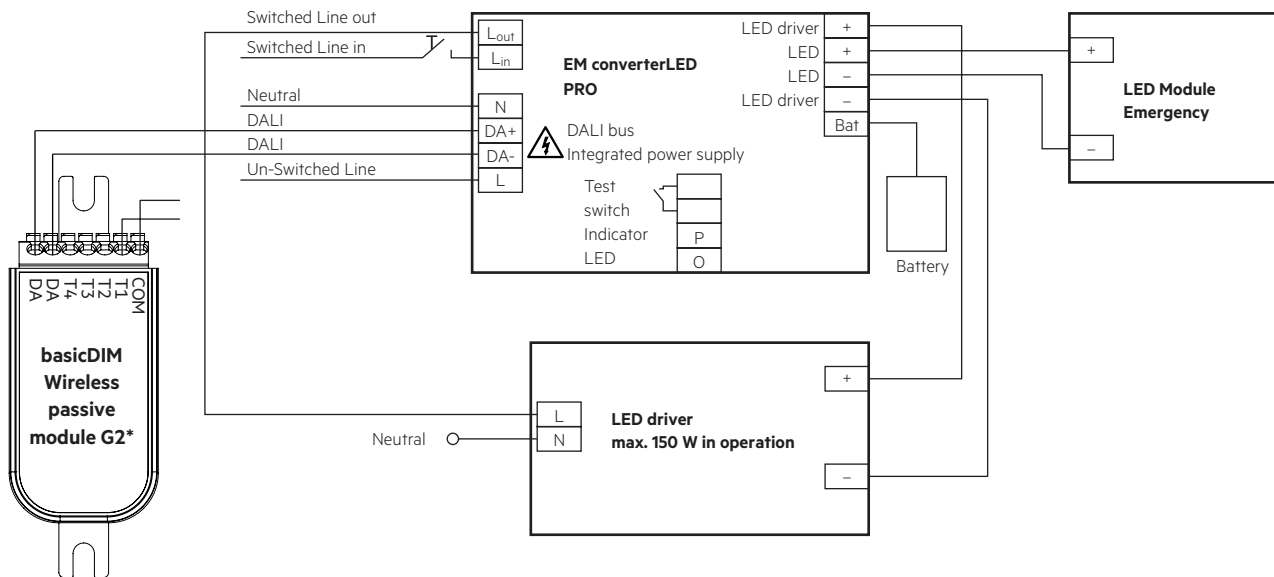

\* For further information see basicDIM Wireless datasheet at [www.tridonic.com](http://www.tridonic.com)

### 3.2 Wiring type and cross section

Solid wire with a cross section of 0.5 – 1.5 mm<sup>2</sup>. Strip 8 – 9 mm of insulation from the cables to ensure perfect operation of terminals.

Wiring: LED module/LED driver/supply

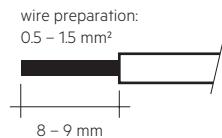

### 3.3 Battery connection

NiMH: Connection with extension cable

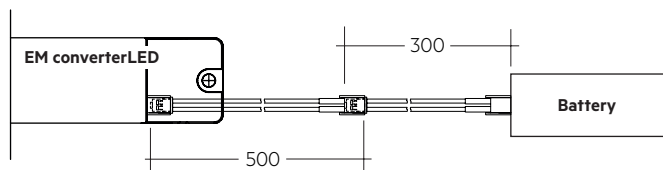

When using an EM converterLED in combination with a NiMH battery, order the CONNECTION CABLE NiMH 500mm separately.

LiFePO<sub>4</sub>: Direct connection

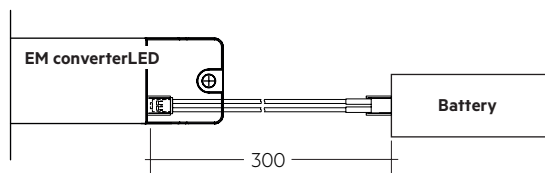

LiFePO<sub>4</sub>: Connection with extension cable

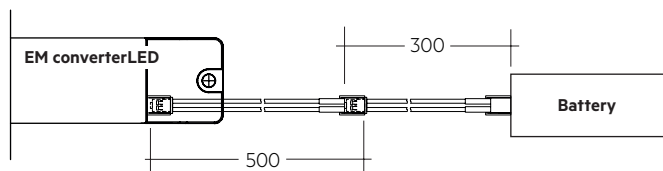

### 3.4 Loose wiring

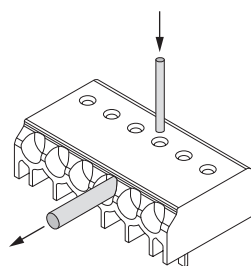

Loosen wire through twisting and pulling or using a Ø 1 mm release tool

### 3.5 Wiring guidelines

- The output to the LED is DC but has high frequency content, which should be considered for good EMC compliance.
- Separate LED leads from the mains and DALI connections and wiring for good EMC performance.
- Maximum lead length on the LED terminals is 3 m. For a good EMC performance keep the LED wiring as short as possible.
- Route the secondary wires (LED module) in parallel to ensure good EMC performance.
- Maximum lead length for the Test switch and Indicator LED connection is 1 m. Separate the test switch and Indicator LED wiring from the LED leads to prevent noise coupling.
- Battery leads are specified with 0.5 mm cross section and a length of 0.8 m
- DALI terminals are mains proof.
- Protect the wiring against short circuits to earth (sharp edged metal parts, metal cable clips, louver, etc.) to avoid the damage of the control gear.

To ensure that a luminaire containing LED emergency units complies with EN 55015 for radio frequency conducted interference in both normal and emergency mode it is essential to follow good practice in the wiring layout.

Within the luminaire route the switched and unswitched 50 Hz supply wiring as short as possible and keep it as far away as possible from the LED leads. Through wiring may affect the EMC performance of the luminaire.

### 3.6 Maximum lead length

LED	3 m (6 m loop) <sup>①</sup>
Status indication LED	1 m
Batteries	0.8 m

<sup>①</sup> Note: The length of LED leads to the LED module must not be exceeded. Note that the length of the EM converterLED leads to the LED module is added to the length of the leads from the LED driver to the EM converterLED module when considering the max. permitted lead length of the LED driver. Keep the leads always as short as possible.

### 3.7 Use of different phases

The use of different phases for switched line and unswitched line is allowed. When using different phases, the unswitched line must fail if the switched line fails. This is required to assure correct switching into emergency mode. It can be realised with a relay.

## 4. Mechanical values

### 4.1 Housing properties

- Casing manufactured from polycarbonate.
- Type of protection: IP20
- Max. torque at the mounting screws: 0.8 Nm

### 4.2 Mechanical data accessories

LED status indicator

- Bi-colour
- Mounting hole 6.5 mm diameter, 1 – 1.6 mm thickness
- Lead length 0.3 m / 0.6 m / 1.0 m
- Insulation rating: 90 °C
- Plug connection

Test switch

- Mounting hole 7.0 mm diameter
- Lead length 0.55 m
- Plug connection

Battery connection

- Plug connection 0.3 m
- Extension cable 0.5 m

## 5. Electrical values

### 5.1 Maximum loading of automatic circuit breakers

Automatic circuit breaker type	B10	B13	B16	B20	C10	C13	C16	C20	Inrush current	
Installation Ø	1.5 mm <sup>2</sup>	1.5 mm <sup>2</sup>	1.5 mm <sup>2</sup>	2.5 mm <sup>2</sup>	1.5 mm <sup>2</sup>	1.5 mm <sup>2</sup>	1.5 mm <sup>2</sup>	2.5 mm <sup>2</sup>	I <sub>max</sub>	time
<b>EM converterLED PRO MH/LiFePO4 250V</b>	90	130	130	130	180	260	260	260	3.6 A	120 µs

### 5.2 Insulation matrix

	Mains	Switched Live	Battery, LED, Test switch, Indicator LED	DALI	LED driver
<b>Mains</b>	–	•	••	•	•
<b>Switched Live</b>	•	–	••	•	•
<b>Battery, LED, Test switch, Indicator LED</b>	••	••	–	•	•
<b>DALI</b>	•	•	•	–	•
<b>LED driver</b>	•	•	–	•	–

• Represents basic insulation

•• Represents double or reinforced insulation

When using a non-SELV LED driver insulate the battery, LED, test switch and indicator LED in the luminaire according to the U-OUT rating of the LED driver.

5.3 Typ. LED current/voltage characteristics

The LED current in emergency mode is automatically adjusted by the EM converterLED module based on the total forward voltage of the LED modules connected and the associated battery. The start of the LED in emergency mode does not result in a current peak.

EM converterLED PRO 303 MH/LiFePO4 250V  
 Article number: 89800643  
 NiMH battery, 3.6 V battery voltage  
 800 – 860 mA battery discharge current (tolerance)

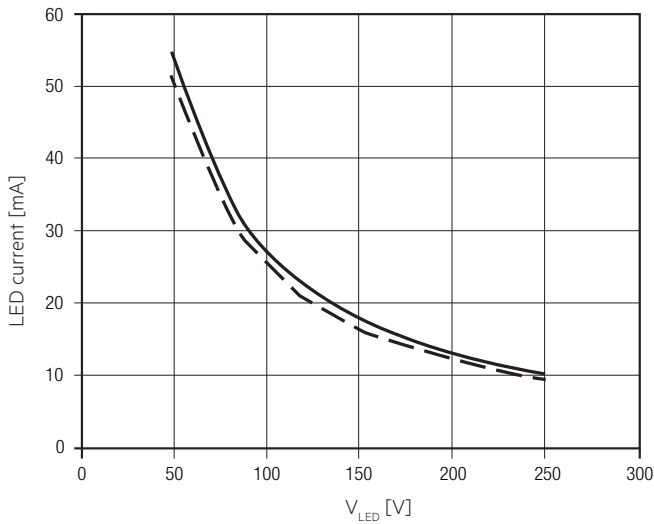

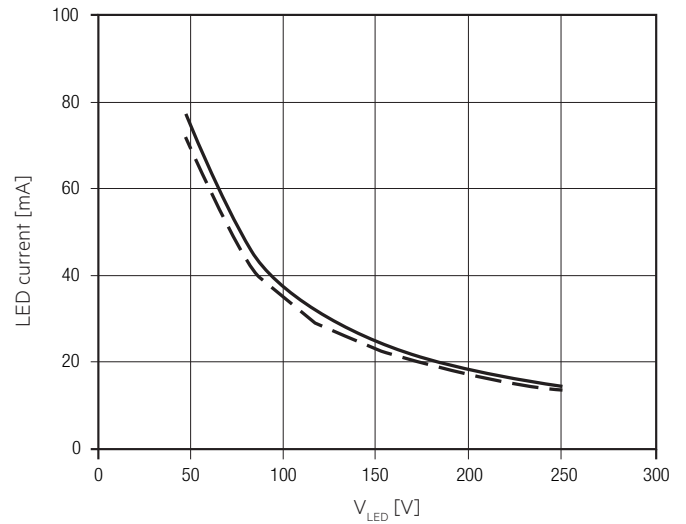

EM converterLED PRO 304 MH/LiFePO4 250V  
 Article number: 89800644  
 NiMH battery, 4.8 V battery voltage  
 810 – 870 mA battery discharge current (tolerance)

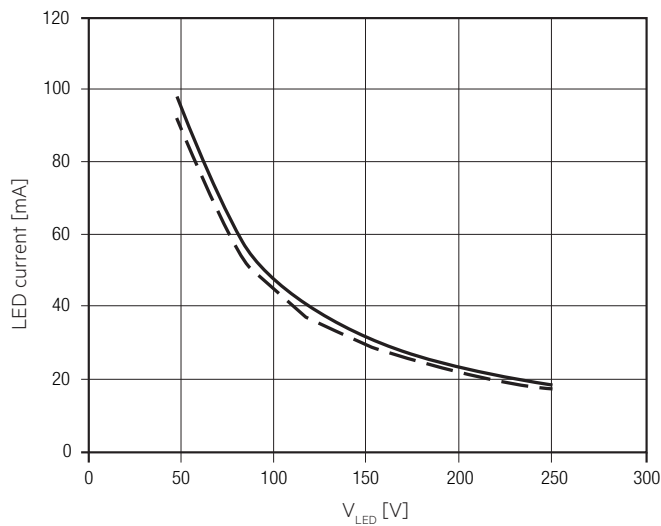

EM converterLED PRO 305 MH/LiFePO4 250V  
 Article number: 89800645  
 NiMH battery, 6.0 V battery voltage  
 820 – 880 mA battery discharge current (tolerance)  
 LiFePO<sub>4</sub> battery, 3.2 V battery voltage  
 1,700 – 1,820 mA battery discharge current (tolerance)



 LED current at nominal battery voltage and min. battery discharge current  
 LED current at nominal battery voltage and max. battery discharge current

EM converterLED PRO 303 MH/LiFePO4 250V

Article number: 89800643

LiFePO<sub>4</sub> battery, 3.2 V battery voltage

1,150 – 1,250 mA battery discharge current (tolerance)

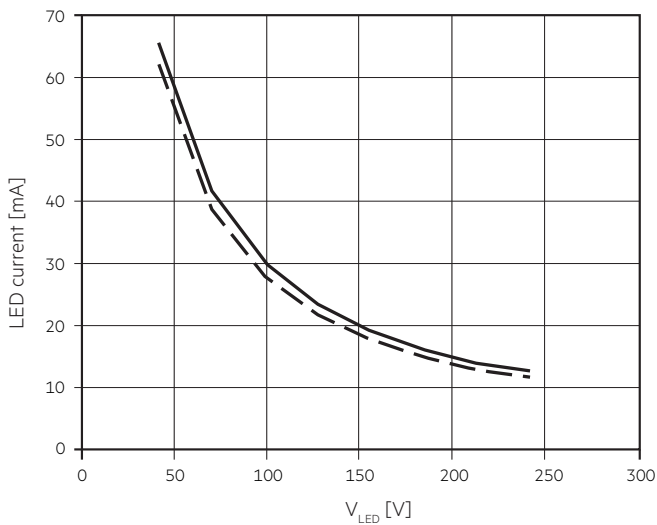



EM converterLED PRO 304 MH/LiFePO4 250V

Article number: 89800644

LiFePO<sub>4</sub> battery, 3.2 V battery voltage

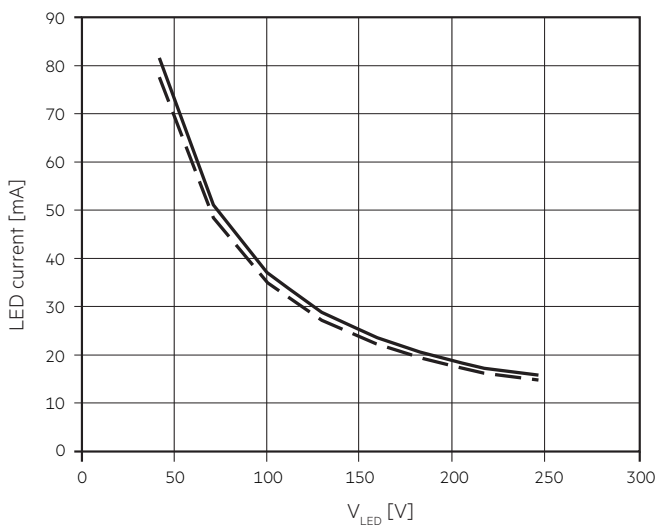
1,450 – 1,550 mA battery discharge current (tolerance)



 LED current at nominal battery voltage and min. battery discharge current  
 LED current at nominal battery voltage and max. battery discharge current

**5.4 LED driver compatibility**

The EM converterLED emergency unit use 3 pole technology and is compatible with most LED drivers on the market, however it is important to check that the rating of the LED driver does not exceed the values specified below:

- The max. allowed output current rating of the associated LED driver is 2 A eff (current rating of the terminals of EM converterLED) and 2.4 A peak (current rating of switching relays of EM converterLED)
- The max. allowed inrush current rating of the associated LED driver is 60 A peak for 1 ms or 84 A for 255 μs (inrush current rating of switching relay of EM converterLED)
- The max. allowed output voltage (U-OUT) of the associated LED driver applied to the EM converterLED output is 450 V (voltage withstand between adjacent contact of the single switching relay of the EM converterLED)
- The max. allowed LED load of the associated LED driver is 150 W in operation. The load must be an LED module.

Check compatibility with the carried out function test (duration at least 5 seconds) individually for each device.

**6. Software / Programming / Interfaces**

**6.1 Software / programming**

With appropriate software and interface different functions can be activated and various parameters can be configured in the LED driver. The Driver supports the following software and interfaces:

Software / hardware for configuration:

- companionSUITE (deviceGENERATOR, deviceCONFIGURATOR, deviceANALYSER)
- masterCONFIGURATOR

Interfaces for data transfer:

- Control input DALI
- NFC

**6.2 Control input (DA+, DA-)**

The DALI Interface allows communication with the Driver via a suitable DALI control unit. The DALI interface is not SELV. Install the control cable (DALI bus) in accordance to the requirements of low voltage installations. DALI terminals are mains voltage proof.

**6.3 Nearfield communication (NFC)**

The NFC Interface allows wireless communication with the LED driver in unpowered state. This interface offers the option to write configuration and to read configuration, errors and events via a suitable NFC antenna and the companionSUITE software.

Place the NFC antenna directly on the LED driver to guarantee a correct communication between the LED driver and the NFC antenna. Any material placed between the LED driver and the NFC antenna can cause a deterioration of the communication quality. We recommend the use of following NFC antennas:

[www.tridonic.com/nfc-readers](http://www.tridonic.com/nfc-readers).

NFC is complied with ISO/IEC 15963 standard.

After programming the device via NFC power up the device one time for one second till the deviceANALYSER can read out the parameters.

Changing parameters via NFC shall be done by qualified engineers only.

## 7. Functions

 companionSUITE:





































DALI-USB, NFC

The companionSUITE with deviceGENERATOR, deviceCONFIGURATOR and deviceANALYSER is available via our WEB page:  
<https://www.tridonic.com/com/en/products/companionsuite.asp>

 masterCONFIGURATOR:

DALI-USB

The masterCONFIGURATOR is available via our WEB page:  
<https://www.tridonic.com/com/en/software-masterconfigurator.asp>

Icon	Function	DALI	NFC
	OEM Identification	 	
	OEM GTIN	 	
	Label information	 	
	Factory reset	 	
	Device operating mode	 	
	Prolong time	 	
	Autotest	 	
	Test window	 	
	Integrated DALI bus power supply voltage (IPS)	 	

### 7.1 OEM Identification



The OEM (Original Equipment Manufacturer) can set his own identification number.

### 7.2 OEM GTIN



The Original Equipment Manufacturer (OEM) can set his own Global Trade Item Number (GTIN).

**7.3 Label information**



In production, an individual label can be printed out for each device. For this there are different default values (Batch No., Production Date, ...) available. In addition, you can use these two text input fields to insert your own luminaire information and print it out.

- Article number (48 characters)
- Description (6 x 48 characters)



This information is not stored on the device, it is only used for the label print function in the deviceCONFIGURATOR.

**7.4 Prolong time**



Prolong time can be set by the DALI controller. Here you can set how long the emergency operation will be maintained after power recovery. The module exits the PROLONG mode as soon as the cut-off threshold of the battery voltage has been reached (total discharge protection), that is when the total operating time has been exceeded. The default prolong time is set as 0 minutes as specified within the DALI standard. Indicator LED will stay off for the duration of the prolong time.

**7.5 Autotest**



**7.5.1 Functional test**

The time of day and frequency of the 5 seconds function test can be set by the DALI controller. The default setting is a 5 seconds test on a weekly basis.

**7.5.2 Duration test**

The time of day and frequency of the duration test can be set by the DALI controller. The default setting is a duration test conducted every 52 weeks.

For 2 h operation:  
The first commissioning duration test has a time of 120 minutes, subsequent through life tests are conducted for 90 minutes. When the battery is changed or disconnected and re-connected the unit will next conduct a 120 minute test.

**7.6 Test window**



The test window sets the maximum time between the scheduled start time or test request via DALI and the actual execution of the test. If the test cannot be executed in the test window, the TEST EXECUTION TIMEOUT bit in the FAILURE STATUS is set.

**7.7 Integrated DALI bus power supply voltage (IPS)**



This feature can optionally be activated (by default it is disabled).

IPS = 50 mA and IPS\_max = 250 mA.  
The minimum guaranteed output current is 50 mA.  
I<sub>max</sub> = 250 mA

Note: The voltage drop in the DALI wires must not exceed 2 V.



No other DALI power supply is allowed to be connected in parallel.

If the IPS function is activated, do not integrate the Driver into an existing DALI network with active DALI bus power supply.

**7.8 Duration link selection**

Duration	Link position
3 hr	 Position A
2 hr	 No duration link
1 hr	 Position B

Emergency lighting LED driver supplied with duration link in 3 hours position (position A).

The position of the link will only be read on first power up. If it is changed afterwards both the battery and mains supply must be disconnected for 10 seconds to enable the EM converterLED to read the new link position on reconnection of the battery and mains. It will lead to a false battery failure indication if the link is changed after installation without this reset.

## 7.9 Status indication

System status is indicated by a bi-colour LED and by a DALI status flag.

LED indication	Status	Comment
Permanent green	System OK	AC mode
Fast flashing green (0,1 sec on – 0,1 sec off)	Function test underway	
Slow flashing green (1 sec on – 1 sec off)	Duration test underway	
Red LED on	Load failure	Open circuit / Short circuit / LED failure
Slow flashing red (1 sec on – 1 sec off)	Battery failure	Battery failed the duration test or function test / Battery is defect or deep discharged / Incorrect battery voltage / battery outside operating temp
Fast flashing red (0,1 sec on – 0,1 sec off)	Charging failure	Incorrect charging current
Double pulsing green	Inhibit mode	Switching into inhibit mode via controller
Binary transmission of address via green/red LED	Address identification	During address identification mode
Green and red off	DC mode	Battery operation (emergency mode)

## 7.10 Testing

### DALI Control

A DALI command from a suitable control unit can be used to initiate function and duration tests at individually selected times. Status flags are set for report back and data logging of results.

When a DALI bus has not been connected or when a DALI bus is connected but the DALI default DELAY and INTERVAL times have not been re-set by sending appropriate DALI commands, then the EM converterLED PRO will conduct self-tests in accordance with the default times set within the EEPROM.

These default times are factory pre-set, in accordance with the DALI standard EN 62386-202, to conduct an automatic function test every 7 days and a duration test every 52 weeks. Since the DELAY time is factory pre-set to Zero, all units are tested at the same time. Test times can be changed with a command over the DALI bus.

The DELAY and INTERVAL time values must be re-set when the emergency system test times are to be scheduled by a DALI control and monitoring system.

Note that once the default values have been set to Zero, tests will only be conducted following a command from the control system. If the DALI bus is disconnected the EM converterLED PRO does not revert to self-testing mode.

### Addressing

The EM converterLED PRO includes the EZ easy addressing system which allows addressing and identification by using the bi-colour LED in conjunction with the EM PRO addressing tool. Binary address codes given by the LED can be simply converted to the DALI addresses 0 to 63. For single handed addressing using this method it is necessary to send a broadcast ident command every 3 to 9 seconds. During this command the LEDs will be switched off and the indication LED will flash the 6 bit binary address preceded by a 3 second start indication period.

## Commissioning

After installation of the luminaire and initial connection of the mains and battery supply to the EM converterLED PRO the device starts with the 20 hours initial charge followed by a 4 hours trickle charge for NiCd/NiMH batteries or with a 24 hours initial charge for LiFePO4 batteries.

Afterwards the device conducts a commissioning test for the full duration. The 20 hours recharge for NiCd/NiMH batteries or 24 hours recharge for LiFePO4 batteries occurs also with the connection of a new battery. The following automatic commissioning duration test only takes place when a battery is replaced and fully charged and the interval time is not set to zero. In case the interval time is set to zero the device expects the DALI system to request the testing.

### Rest Mode / Inhibit Mode

Emergency operation is automatically started when the mains supply is switched off. If the Rest Mode is activated, the discharging of the battery will be minimized by switching off the LED output. If the Inhibit Mode has been activated before the mains supply is switched off, Rest Mode will be automatically switched on if the mains supply is switched off within 15 minutes. Rest Mode and Inhibit Mode can be initiated by the DALI controller. The REST command has to be sent after the mains supply has been disconnected and whilst the EM converterLED PRO is in emergency operation. The INHIBIT command has to be sent while the EM converterLED PRO is supplied by mains.

After a mains reset the EM converterLED PRO exits the Rest Mode. Rest Mode and Inhibit Mode can both be disabled by sending the RE-LIGHT / RESET INHIBIT command. Rest Mode / Inhibit Mode are not supported from EM converterLED in case of combination with a 1-cell LiFePO4 battery and 2-cell NiMH battery.

### Test switch

An optional test switch can be wired to each EM converterLED. This can be used to to:

- Initiate a 5 seconds function test: press 200 ms < T < 1 s
- Execute function test as long as switch pressed: press > 1 s
- Reset selftest timer (adjust local timing): press > 10 s

### Timer reset functionality

The timer for function and duration test can be set to a particular time of the day by either pressing the test switch for longer than 10 seconds or cycling the unswitched line supply 5 times within 1 minute. The timer adjustment will enable the test start time to be defined manually at time in day when the timer was reset. It will also disable the adaptive test algorithm thereby forcing the unit to perform the test at the same time rather than it being defined by the adaptive algorithm. This function will only work provided the interval time is greater than zero (automatic test mode enabled). The factory programmed delay offset (1 – 28 days) will be loaded after the reset into the delay timer for the function and duration test in order to randomize the tests between adjacent units.

### BlackBox data recording

Parameters providing information about the application and use are stored in the EM converterLED PRO. The parameters stored provide information on the mains, battery, LED output and emergency operation. The BlackBox can be read out with the masterCONFIGURATOR and deviceANALYSER.

### DALI Controller

DALI controllers and hardware/software solutions are available from Tridonic. Please refer to the Lighting controls section.

## 8. Battery data

### 8.1 Battery selection

EM converterLED PRO, 1 / 2 / 3 h

Technology and capacity	Design	Number of cells	Type	Article no.	EM converterLED PRO 303 MH/LiFePO4 250V		EM converterLED PRO 304 MH/LiFePO4 250V		EM converterLED PRO 305 MH/LiFePO4 250V	
					89800643		89800644		89800645	
					1 h	2/3 h	1 h	2/3 h	1 h	2/3 h
					Assignable batteries					
NiMH 4,0 Ah LA cells	stick	1 x 3	Accu-NiMH 3A CON	89800441		•				
	stick	1 x 4	Accu-NiMH 4A CON	89800442				•		
	stick + stick	2 + 2	Accu-NiMH 4C CON	89800438				•		
	stick + stick	2 + 3	Accu-NiMH 5C CON	89800439						•
LiFePO <sub>4</sub> 1,5 Ah 18650 cells	stick	1 x 2	Accu-LiFePO4 2A CON	28002318	•		•		•	
	stick	1 x 4	Accu-LiFePO4 4A CON	28002322		•				
	stick	1 x 5	Accu-LiFePO4 5A CON	28002325				•		
	stick + stick	2 + 2	Accu-LiFePO4 4C CON	28002324		•				
	stick + stick	2 + 3	Accu-LiFePO4 5C CON	28002327				•		
	stick + stick	3 + 3	Accu-LiFePO4 6C CON	28002330						•
	side by side	5 x 1	Accu-LiFePO4 5B CON	28002326				•		
	side by side	2 x 1	Accu-LiFePO4 2B CON	28002319	•		•		•	
	remote box	1 x 2	PACK-LiFePO4 3.0Ah 2 CON	28005854	•		•		•	
	remote box	1 x 3	PACK-LiFePO4 4.5Ah 3 CON	28005855						
	remote box	1 x 4	PACK-LiFePO4 6.0Ah 4 CON	28005856		•				
	remote box	1 x 5	PACK-LiFePO4 7.5Ah 5 CON	28005857				•		
	remote box	1S1P	PACK-LiFePO4 3.3Ah 1 CON	28005859	•		•		•	

### 8.2 Battery charge / discharge data

EM converterLED PRO, 1 / 2 / 3 h, NiMH

	Type	EM converterLED PRO 303 MH/LiFePO4 250V		EM converterLED PRO 304 MH/LiFePO4 250V		EM converterLED PRO 305 MH/LiFePO4 250V	
		89800643		89800644		89800645	
		1 h	2/3 h	1 h	2/3 h	1 h	2/3 h
Battery charge time	Initial charge	20 h					
	Fast recharge	10 h	15 h	10 h	15 h	10 h	15 h
	Trickle charge	continuously					
Charging current	Initial charge	110 – 150 mA	280 – 320 mA	110 – 150 mA	280 – 320 mA	110 – 150 mA	280 – 320 mA
	Fast recharge	190 – 230 mA	310 – 350 mA	190 – 230 mA	310 – 350 mA	190 – 230 mA	310 – 350 mA
	Trickle charge	110 – 150 mA / 4 min. 0 mA / 16 min.	180 – 220 mA / 4 min. 0 mA / 16 min.	110 – 150 mA / 4 min. 0 mA / 16 min.	180 – 220 mA / 4 min. 0 mA / 16 min.	110 – 150 mA / 4 min. 0 mA / 16 min.	180 – 220 mA / 4 min. 0 mA / 16 min.
Discharge current	800 – 860 mA	800 – 860 mA	810 – 870 mA	810 – 870 mA	820 – 880 mA	820 – 880 mA	
Charge voltage range <sup>®</sup>	0,9 – 1,65 V per cell						
Discharge voltage range	1,65 – 1,05 V per cell						

<sup>®</sup> The battery will be charged below 0,9 V. The EM converterLED will indicate a battery fault.

The emergency lighting LED driver will recharge the battery normally after running the test of 61347-2-7 CL 22.3 (abnormal operating conditions).

EM converterLED PRO, 1 / 2 / 3 h, LiFePO<sub>4</sub>

Type	EM converterLED PRO 303 MH/LiFePO <sub>4</sub> 250V		EM converterLED PRO 304 MH/LiFePO <sub>4</sub> 250V		EM converterLED PRO 305 MH/LiFePO <sub>4</sub> 250V		
	89800643		89800644		89800645		
	1 h	2/3 h	1 h	2/3 h	1 h	2/3 h	
Battery charge time	Initial charge						24 h
	Fast recharge						24 h
	Trickle charge						continuously and battery voltage controlled
Charging current	Initial charge	250 – 290 mA	430 – 470 mA	250 – 290 mA	430 – 470 mA	250 – 290 mA	430 – 470 mA
	Fast recharge	250 – 290 mA	430 – 470 mA	250 – 290 mA	430 – 470 mA	250 – 290 mA	430 – 470 mA
	Trickle charge <sup>Ⓟ</sup>	250 – 290 mA / 0 mA	430 – 470 mA / 0 mA	250 – 290 mA / 0 mA	430 – 470 mA / 0 mA	250 – 290 mA / 0 mA	430 – 470 mA / 0 mA
Discharge current	1,150 – 1,250 mA	1,150 – 1,250 mA	1,450 – 1,550 mA	1,450 – 1,550 mA	1,700 – 1,820 mA	1,700 – 1,820 mA	
Charge voltage range <sup>Ⓟ</sup>	2.0 – 3.65 V						
Discharge voltage range	3.65 – 2.60 V						

<sup>Ⓟ</sup> Automatic recharge when battery voltage falls below 3.4 V. Charger off (0 mA) when battery voltage exceeds 3.6 V.

Note: Battery protected against operation at excessive temperatures (charging stopped when battery cell temperature < 0 °C or > 60 °C).

The emergency lighting LED driver will recharge the battery normally after running the test of 61347-2-7 CL 22.3 (abnormal operating conditions).

<sup>Ⓟ</sup> The battery will not be charged below 2.0 V.

**8.3 Accu-NiMh****Capacity 4.0 Ah**

International designation	HRMU 19/90
Battery voltage/cell	1.2 V
Cell type	LA
Case temperature range to ensure 4 years design life	+5 °C to +50 °C
Max. short term battery case temperature (shorter than 1 month over the battery lifetime)	70 °C
Max. number discharge cycles	4 cycles per year plus 30 cycles during commissioning
Max. storage time	12 months at -20 °C to +25 °C

**8.4 Accu-LiFePO4****Capacity 1.5 Ah**

International designation	IFpR 19/66
Battery voltage/cell	3.2 V
Cell type	18650
Case temperature range to ensure 5 years design life	+5 °C to +60 °C
7 years design life	+5 °C to +55 °C
10 years design life	+5 °C to +45 °C
12 years design life	+5 °C to +35 °C
Max. short term battery case temperature (shorter than 1 month over the battery lifetime)	70 °C
Max. number discharge cycles	50 cycles total
Max. storage time	15 months at -20 °C to +35 °C

**8.5 Accupack-NiMH****4.0 Ah**

Battery voltage/cell	1.2 V
Cell type	LAL
Ambient temperature range to ensure 4 years design life tc point	+5 °C to +35 °C +40 °C
Max. short term battery case temperature (shorter than 1 month over the battery lifetime)	70 °C
Max. number discharge cycles	4 cycles per year plus 4 cycles during commissioning
Max. storage time	12 months

**8.6 Accupack-LiFePO4****Capacity 1.5 Ah**

International designation	IFpR 19/66
Battery voltage/cell	3.2 V
Cell type	18650
Case temperature range to ensure 4 years design life	+5 °C to +45 °C
6 years design life	+5 °C to +35 °C
8 years design life	+5 °C to +25 °C
Max. short term battery case temperature (shorter than 1 month over the battery lifetime)	70 °C
Max. number discharge cycles	50 cycles total
Max. storage time	15 months at -20 °C to +35 °C

Only use Tridonic batteries.

Comply with UN 38.3 and IEC 62133 (safety testing) protected against over charge, over discharge, charging at excessive temperatures, short-circuit and over current.

**8.7 Accu / Accupack-LiFePO4****Capacity 3.3 / 6.6 Ah**

International designation	IFpR 27/66
Battery voltage/cell	3.2 V
Cell type	26650
Case temperature range to ensure 4 years design life	+5 °C to +45 °C
Max short term battery case tc point temperature (reduced lifetime)	70 °C
Max. number discharge cycles	50 cycles total
Max. storage time	15 months at -20 °C to +35 °C

## 8.8 Safety LiFePO<sub>4</sub>



Note: LiFeGuard ensures safe and reliable battery operation by offering a comprehensive three-layered safety system.

It addresses the cell, battery pack and emergency driver.

### 8.8.1 Deep discharge protection

When the battery remains connected without charging for a long period of time after the battery cut off of the driver the battery voltage can still drop. To make sure the cells are not damaged by this voltage drop, the battery protection prevents the battery from further discharge below 2.0 V.

### 8.8.2 Overcharge protection

If in case of an error or the use of a wrong driver the battery gets overcharged the battery protection will disconnect the battery from the driver at a voltage of 3.9 V. A discharge of the battery is still possible after the protection circuit was triggered to guarantee emergency operation.

### 8.8.3 Short-circuit protection

In case of a short circuit the battery protection opens the connection to the driver and the output is therefore free of voltage. The output will be reactivated again when the short circuit is removed.

### 8.8.4 Overtemperature protection

The battery is protected against temporary thermal overheating. If the temperature limit is exceeded the further charging of the battery is no longer possible. The temperature protection is activated below approx. 0 °C and above approx. +60 °C. The discharging of the battery is still possible to guarantee emergency operation. The charging is automatically activated when the temperature is within the range of 0 to 60°C again.



Battery has built in thermal sensor for safe charging. Mount battery away from heat source.

Positioning of the thermal sensor see battery data sheet.

## 8.9 Storage, installation and commissioning

Relevant information about storage conditions, installation and commissioning are provided in the battery datasheets.

Activating NiMH batteries:

In order to activate new batteries, 2-3 full charge-discharge cycles could be needed. This activating process is defined by charging (24 h) and discharging (1/2/3 h) of the batteries. If the first duration test fails, please repeat the test after a 24 hour charging period.

## 9. Miscellaneous

### 9.1 Conditions of use and storage

Humidity: 5% up to max. 85 %, not condensed (max. 56 days/year at 85 %)

Storage temperature: -40 °C up to max. +80 °C

The devices have to be acclimatised to the specified temperature range (ta) before they can be operated.

### 9.2 Maximum number of switching cycles

EM converterLEDs are tested with 50,000 mains switching cycles of the associated LED driver.

### 9.3 Battery replacement

After a battery replacement and a subsequent full charge cycle (24 h) a duration test is mandatory to prove that with the new battery the rated duration is achieved.

### 9.4 FELV control terminals



FELV control terminals marked „Risk of electric shock“ are not safe to touch. Insulate circuits connected to any FELV control terminal for the Low Voltage supply voltage of the control gear. Protect terminals connected to the FELV circuit against accidental contact.

### 9.5 Black Box data recording

Several parameters in respect to the application and use of the product are stored in the EM converterLED. The parameters provide information about the mains, battery, LED output and emergency operation. The Black Box can be read out with the masterCONFIGURATOR and deviceANALYSER via DALI and NFC.

In order to allow a safe detection of a battery replacement through the “Black Box data recording” follow the below described process.

Battery replacement

1. Disconnect mains
2. Disconnect battery
3. Reconnect and disconnect mains while no battery is not connected<sup>①</sup>
4. Connect new battery
5. Connect mains<sup>②</sup>

<sup>①</sup> Battery fault is safely recorded by the EM converterLED

<sup>②</sup> Connection of new battery is recorded by the EM converterLED

### 9.6 Mains-connected transformers

The EM converterLED does not contain mains-connected windings of transformers.

### 9.7 Additional information

Additional technical information at [www.tridonic.com](http://www.tridonic.com) → Technical Data

Lifetime declarations are informative and represent no warranty claim. No warranty if device was opened.