

Driver LC 75W 24V IP67 L EXC UNV

excite series 24 V – not dimmable (IP67)

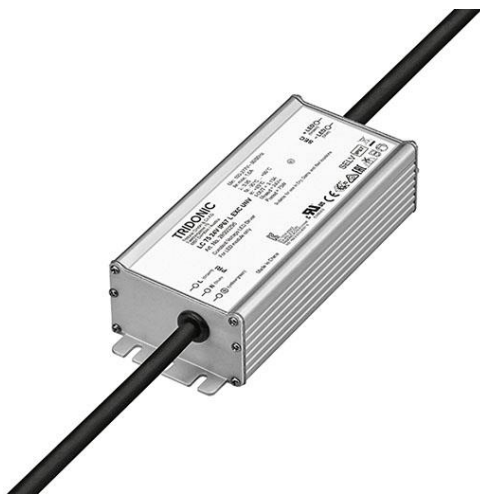

Product description

- _ Constant voltage LED driver
- _ Universal input voltage range
- _ Max. output power 75 W
- _ Nominal lifetime up to 50,000 h
- _ 5 years guarantee (conditions at <https://www.tridonic.com/manufacturer-guarantee-conditions>)

Housing properties

- _ Casing: aluminium, grey
- _ Type of protection IP67
- _ Dry, damp and wet location
- _ Potted version: higher protection against corrosion

Functions

- _ Overtemperature protection
- _ Overload protection
- _ Short-circuit protection
- _ No-load protection

Website

<http://www.tridonic.com/28003296>

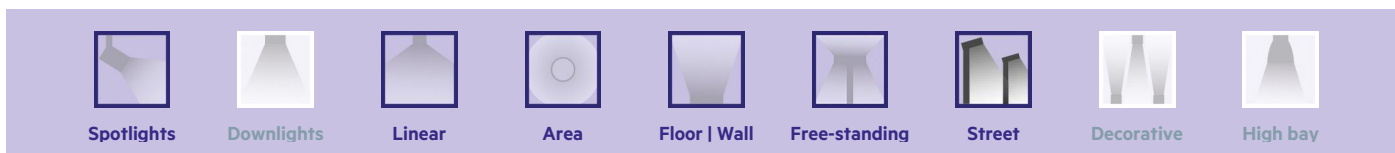

Driver LC 75W 24V IP67 L EXC UNV

excite series 24 V – not dimmable (IP67)

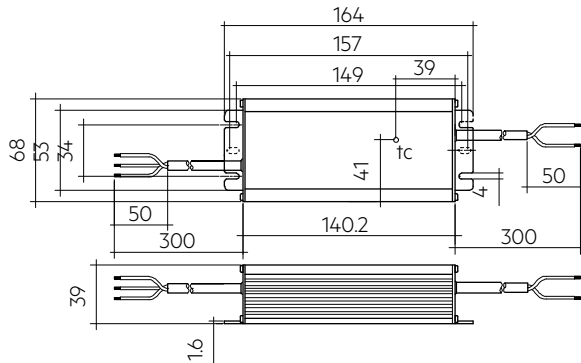
**Ordering data**

Type	Article number	Packaging, carton	Packaging, pallet	Weight per pc.
LC 75 24V IP67 L EXC UNV	28003296	10 pc(s).	240 pc(s).	0.73 kg

Technical data

Rated supply voltage	100 – 277 V
AC voltage range	90 – 305 V
Mains frequency	50 / 60 Hz
Rated current (at 120 V, 60 Hz, full load)	1 A
Rated current (at 230 V, 50 Hz, full load)	1 A
Rated current (at 277 V, 60 Hz, full load)	1 A
Leakage current (at 120 V, 60 Hz, full load)	< 750 μ A
Leakage current (at 230 V, 50 Hz, full load)	< 750 μ A
Leakage current (at 277 V, 60 Hz, full load)	< 750 μ A
Efficiency (at 120 V 60 Hz, full load)	> 84 %
Efficiency (at 230 V, 50 Hz, full load)	> 86 %
Efficiency (at 277 V 60 Hz, full load)	> 86 %
λ (at 120 V, 60 Hz, full load)	0.98
λ (at 230 V, 50 Hz, full load)	0.95
λ (at 277 V, 60 Hz, full load)	0.9C
Typ. input power in no-load operation	1.08 W
Output voltage tolerance	22.8 – 25.2 V
Max. output power	75 W
Output LF voltage ripple (< 120 Hz)	\pm 5 %
Starting time (output)	\leq 500 ms
Hold on time at power failure (output)	\leq 1 ms
Mains burst capability	1 kV
Mains surge capability (between L - N)	4 kV
Mains surge capability (between L/N - PE)	10 kV
Surge voltage at output side (against PE)	< 0.5 kV
Max. casing temperature t_c	85 °C
Ambient temperature t_a (at lifetime 50,000 h)	50 °C
Storage temperature t_s	-40 ... +85 °C
Type of protection	IP67
Lifetime	up to 50,000 h
Guarantee (conditions at www.tridonic.com)	5 Year(s)
Dimensions L x W x H	164 x 68 x 39 mm
Hole spacing D	149 mm

Approval marks**Standards**

EN 55015, EN 61000-3-2, EN 61000-3-3, EN 61347-1, EN 61347-2-13, EN 62384, EN 60598-1, UL 8750

Specific technical data

Type	Load	Output voltage	Output current	Max. output power (at full load)	Typ. power consumption (at 120 V, 60 Hz, full load)	Typ. current consumption (at 120 V, 60 Hz, full load)	Typ. power consumption (at 230 V, 50 Hz, full load)	Typ. current consumption (at 230 V, 50 Hz, full load)	Typ. power consumption (at 277 V, 60 Hz, full load)	Typ. current consumption (at 277 V, 60 Hz, full load)	Ambient temperature t_a
LC 75 24V IP67 L EXC UNV	10 %	23.9 V	314 mA	7.5 W	10.3 W	95 mA	10.6 W	69 mA	10.1 W	70 mA	-40 ... +60 °C
LC 75 24V IP67 L EXC UNV	20 %	23.9 V	627 mA	15.0 W	19.3 W	168 mA	19.6 W	103 mA	19.5 W	96 mA	-40 ... +60 °C
LC 75 24V IP67 L EXC UNV	30 %	23.8 V	939 mA	22.4 W	27.4 W	234 mA	27.5 W	136 mA	27.7 W	121 mA	-40 ... +60 °C
LC 75 24V IP67 L EXC UNV	40 %	23.8 V	1,252 mA	29.9 W	35.6 W	301 mA	35.5 W	170 mA	35.9 W	161 mA	-40 ... +60 °C
LC 75 24V IP67 L EXC UNV	50 %	23.8 V	1,565 mA	37.3 W	43.8 W	369 mA	43.4 W	201 mA	43.6 W	188 mA	-40 ... +60 °C
LC 75 24V IP67 L EXC UNV	60 %	23.8 V	1,878 mA	44.8 W	52.3 W	439 mA	51.5 W	235 mA	51.6 W	208 mA	-40 ... +60 °C
LC 75 24V IP67 L EXC UNV	70 %	23.8 V	2,191 mA	52.2 W	60.8 W	509 mA	59.7 W	270 mA	59.6 W	234 mA	-40 ... +60 °C
LC 75 24V IP67 L EXC UNV	80 %	23.8 V	2,503 mA	59.7 W	69.2 W	580 mA	67.7 W	304 mA	67.6 W	259 mA	-40 ... +60 °C
LC 75 24V IP67 L EXC UNV	90 %	23.8 V	2,816 mA	67.1 W	77.8 W	651 mA	75.9 W	339 mA	75.7 W	287 mA	-40 ... +60 °C
LC 75 24V IP67 L EXC UNV	100 %	23.8 V	3,130 mA	74.5 W	86.3 W	722 mA	85.0 W	373 mA	83.8 W	316 mA	-40 ... +60 °C

1. Standards

EN 55015
 EN 61000-3-2
 EN 61000-3-3
 EN 61347-1
 EN 61347-2-13
 EN 62384
 EN 60598-1
 UL8750

2. Thermal details and lifetime

2.1 Expected lifetime

120 V, 60 Hz

Type	Output voltage	ta	55 °C	60 °C	65 °C	70 °C
LC 75W 24V IP67 L EXC UNV	24 V	tc	80 °C	85 °C	90 °C	95 °C
		Lifetime	> 45,000 h	> 30,000 h	> 20,000 h	> 15,000 h

230 V, 50 Hz

Type	Output voltage	ta	55 °C	60 °C	65 °C	70 °C
LC 75W 24V IP67 L EXC UNV	24 V	tc	75 °C	80 °C	85 °C	90 °C
		Lifetime	> 90,000 h	> 60,000 h	> 45,000 h	> 30,000 h

277 V, 60 Hz

Type	Output voltage	ta	55 °C	60 °C	65 °C	70 °C
LC 75W 24V IP67 L EXC UNV	24 V	tc	65 °C	70 °C	75 °C	80 °C
		Lifetime	> 90,000 h	> 60,000 h	> 45,000 h	> 30,000 h

3. Installation / Wiring

3.1 Wiring diagram

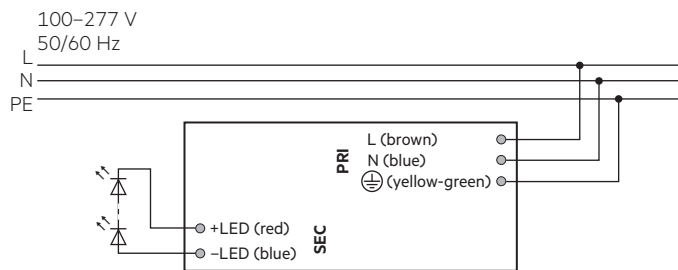

 Recommendation to check glowing at standby in combination with class I luminaires.

3.2 Connection

Primary cable			Secondary cable	
L	N	PE	+	-
brown	blue	yellow-green	brown	blue

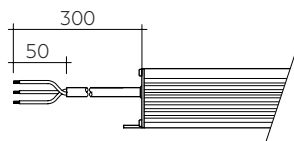

PRI:

3x1.0 mm²

SEC:

2x1.0 mm²

3.3 Wiring guidelines

- All connections must be kept as short as possible to ensure good EMI behaviour.
- To comply with the EMC regulations run the secondary wires (LED module) in parallel.
- Mains leads should be kept apart from LED driver and other leads (ideally 5 – 10 cm distance)
- Max. length of output wires is 2 m.
- Secondary switching is not permitted.
- Incorrect wiring can damage LED modules.
- To avoid damage of the Driver, the wiring must be protected against short circuits to earth (sharp edged metal parts, metal cable clips, louver, etc.).

3.4 Hot plug-in

Hot plug-in is supported.

3.5 Earth connection

The earth connection is conducted as protection earth (PE). The LED driver can be earthed via metal housing. If the LED driver will be earthed, protection earth (PE) has to be used. There is no earth connection required for the functionality of the LED driver. Earth connection is recommended to improve following behaviour:

- Electromagnetic interferences (EMI)
- LED glowing at standby
- Transmission of mains transients to the LED output

In general it is recommended to earth the LED driver if the LED module is mounted on earthed luminaire parts respectively heat sinks and thereby representing a high capacity against earth.

3.6 Fixing conditions

Dry, acidfree, oilfree, fatfree. It is not allowed to exceed the maximum ambient temperature (t_a) stated on the device. Minimum distances stated below are recommendations and depend on the actual luminaire. Device is not suitable for fixing in corner.

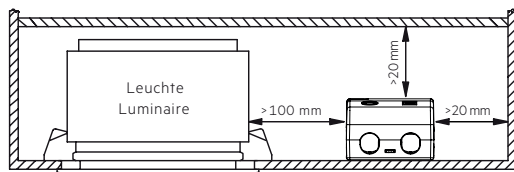

Device not suitable for covering with thermally insulating material according to IEC 60598-1 Ed.9

3.7 Installation instructions

The functioning of the LC in combination with dimming devices (e.g. PWM) cannot be guaranteed and has to be checked individually before using in combination.

For fulfilling the ecodesign requirements of the European Union following has to be considered:

- Going to stand-by via PWM dimmer is not supported.
- To turn off the luminaire, mains has to be off.

4. Electrical values

4.1.1 Efficiency vs. load 120 V, 60 Hz

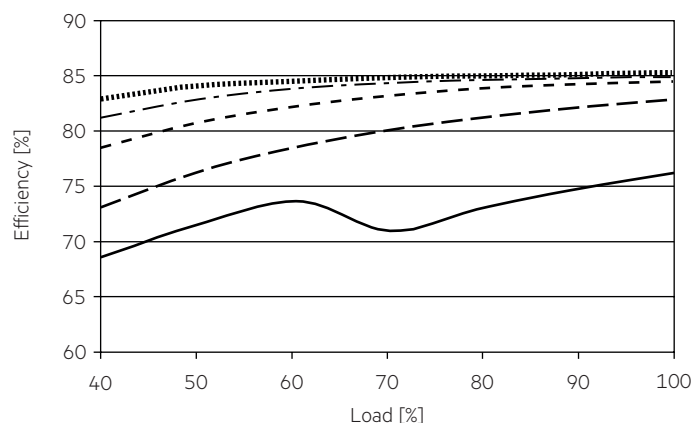

4.1.2 Efficiency vs. load 230 V, 50 Hz

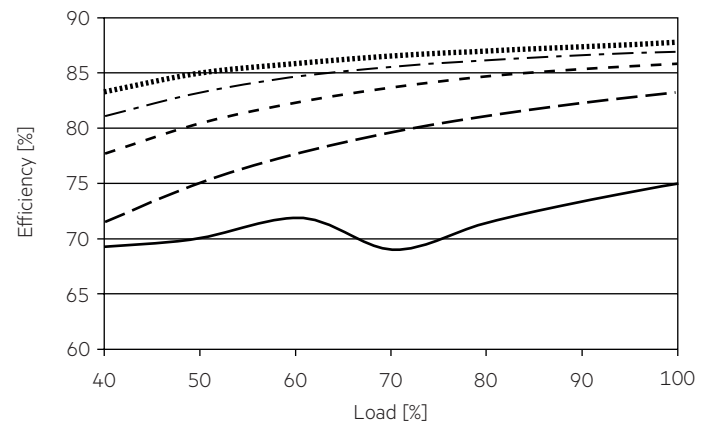

4.1.3 Efficiency vs. load 277 V, 60 Hz

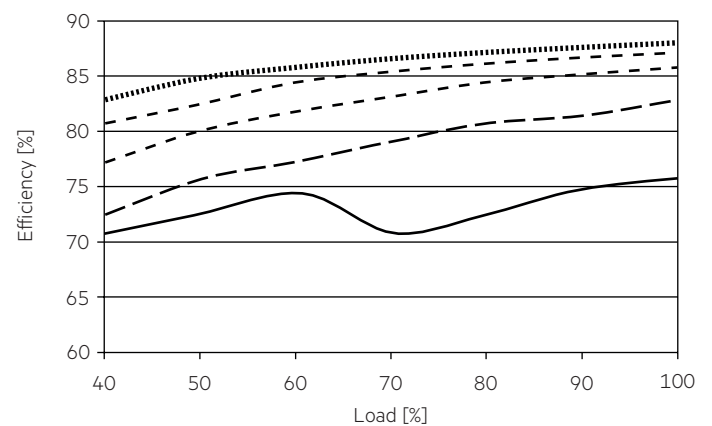

4.2.1 Power factor vs. load 120 V, 60 Hz

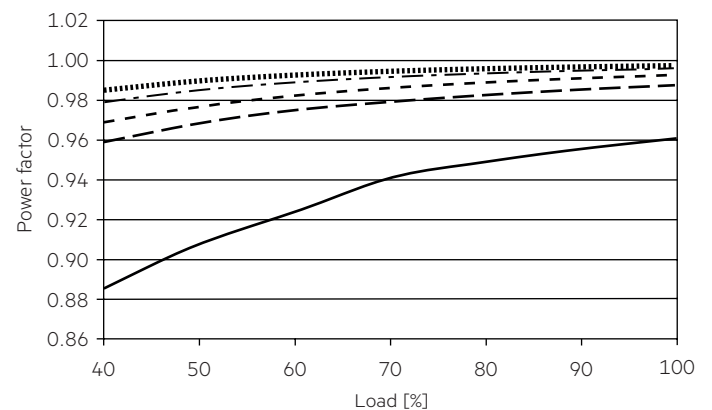

4.2.2 Power factor vs. load 230 V, 50 Hz

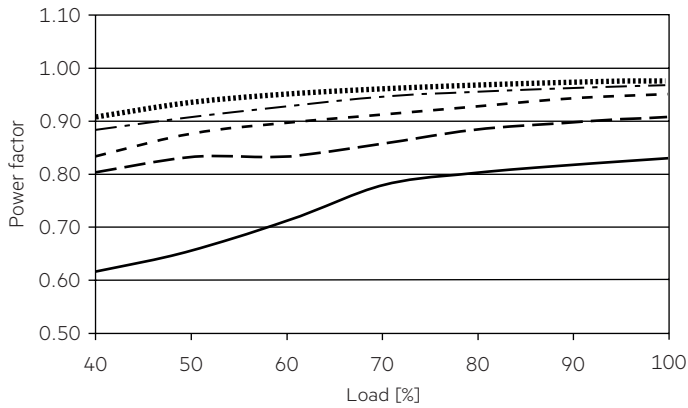

4.3.2 THD vs. load 230 V, 50 Hz

THD without harmonic < 5 mA or 0.6 % of the input current.

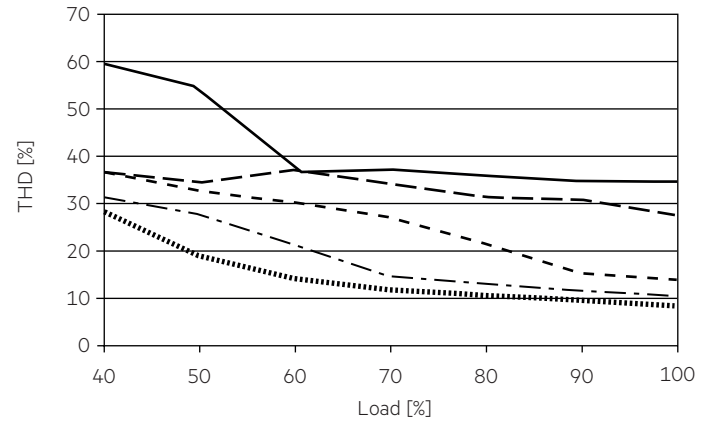

4.2.3 Power factor vs. load 277 V, 60 Hz

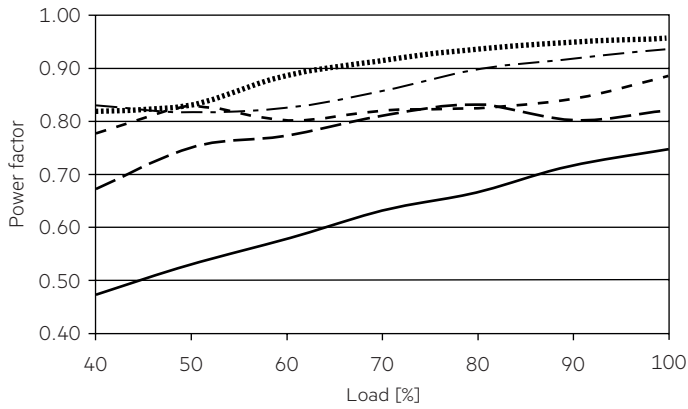

4.3.3 THD vs. load 277 V, 60 Hz

THD without harmonic < 5 mA or 0.6 % of the input current.

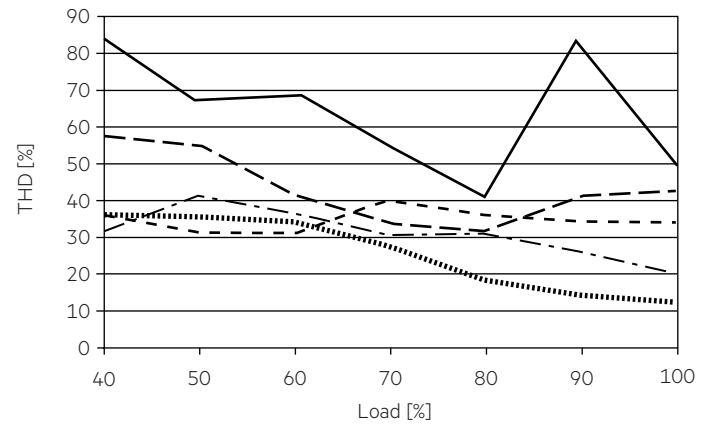

4.3.1 THD vs. load 120 V, 60 Hz

THD without harmonic < 5 mA or 0.6 % of the input current.

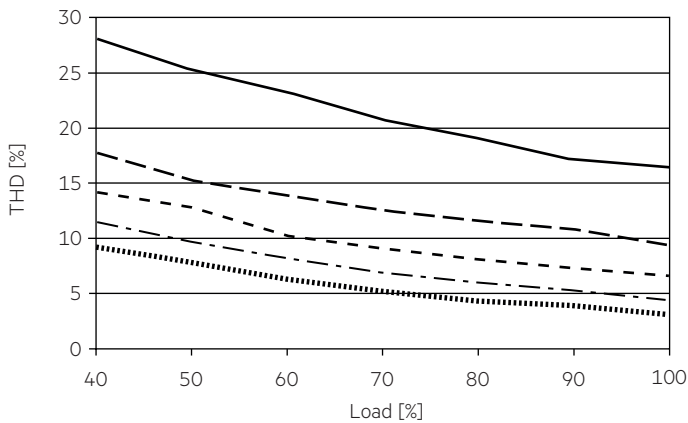

4.4.1 Input current vs. load 120 V, 60 Hz

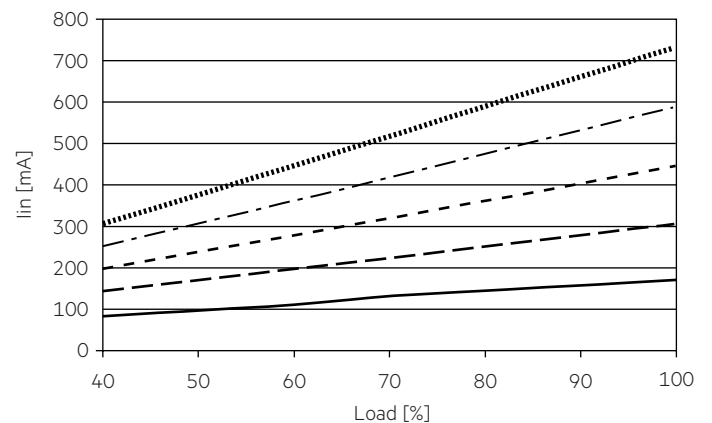

4.4.2 Input current vs. load 230 V, 50 Hz

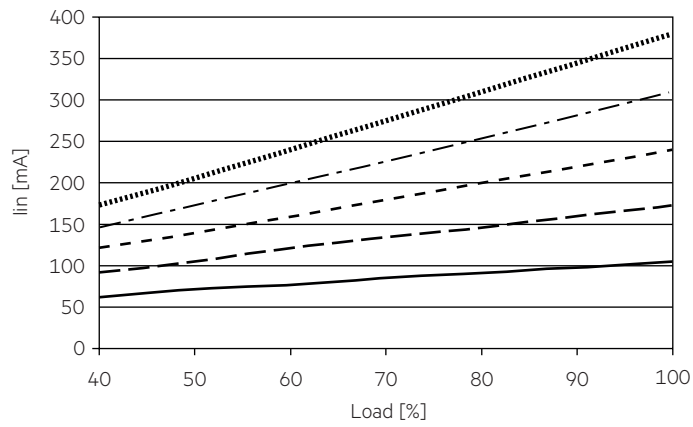

4.5.2 Input power vs. load 230 V, 50 Hz

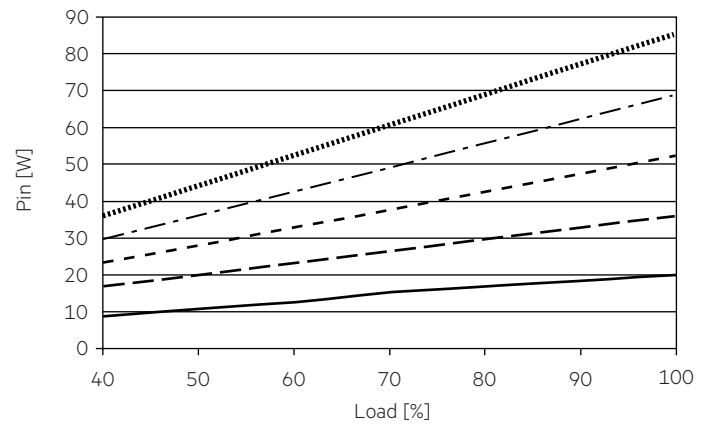

4.4.3 Input current vs. load 277 V, 60 Hz

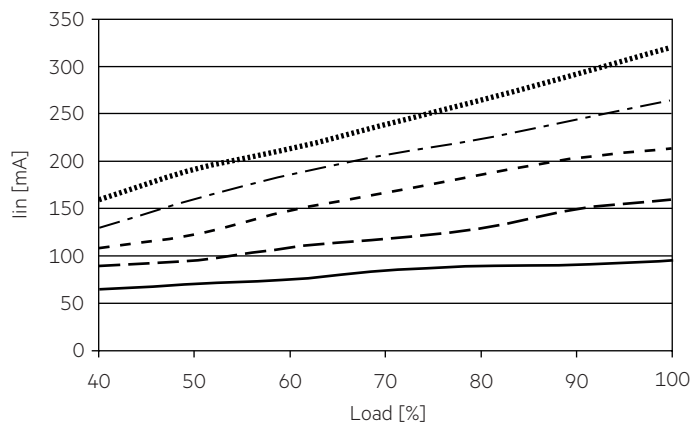

4.5.3 Input power vs. load 277 V, 60 Hz

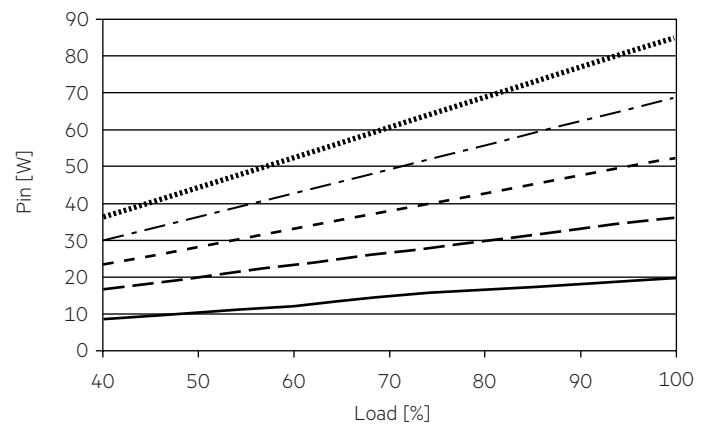

4.5.1 Input power vs. load 120 V, 60 Hz

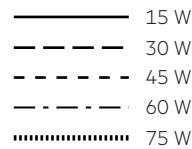
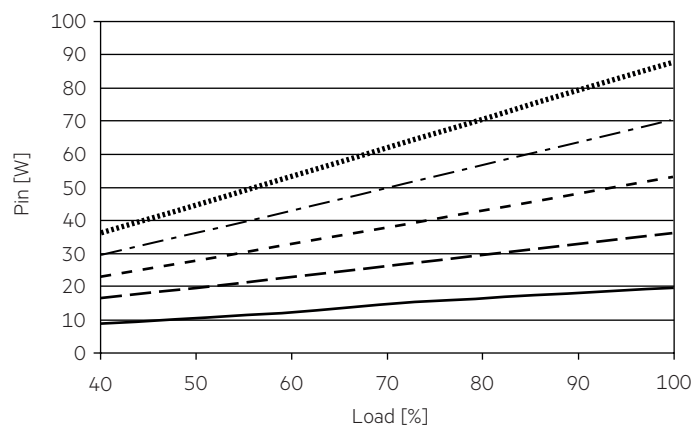

4.6 Maximum loading of automatic circuit breakers

Maximum loading of automatic circuit breakers at 120 V, 60 Hz

Automatic circuit breaker type	C10	C13	C16	C20	B10	B13	B16	B20	Inrush current	
Installation Ø	1.5 mm ²	1.5 mm ²	2.5 mm ²	2.5 mm ²	1.5 mm ²	1.5 mm ²	2.5 mm ²	2.5 mm ²	I _{max}	time
LC 75W 24V IP67 L EXC UNV	5	6	8	10	3	4	5	6	26 A	528 µs

Maximum loading of automatic circuit breakers at 230 V, 50 Hz

Automatic circuit breaker type	C10	C13	C16	C20	B10	B13	B16	B20	Inrush current	
Installation Ø	1.5 mm ²	1.5 mm ²	2.5 mm ²	2.5 mm ²	1.5 mm ²	1.5 mm ²	2.5 mm ²	2.5 mm ²	I _{max}	time
LC 75W 24V IP67 L EXC UNV	5	6	8	10	3	4	5	6	45 A	452 µs

Maximum loading of automatic circuit breakers at 277 V, 60 Hz

Automatic circuit breaker type	C10	C13	C16	C20	B10	B13	B16	B20	Inrush current	
Installation Ø	1.5 mm ²	1.5 mm ²	2.5 mm ²	2.5 mm ²	1.5 mm ²	1.5 mm ²	2.5 mm ²	2.5 mm ²	I _{max}	time
LC 75W 24V IP67 L EXC UNV	5	6	8	10	3	4	5	6	56 A	467 µs

4.7 Harmonic distortion in mains supply in %

120 V, 60 Hz:

Type	THD	3	5	7	9	11
LC 75W 24V IP67 L EXC UNV	< 15	< 12	< 10	< 7	< 5	< 3

230 V, 50 Hz:

Type	THD	3	5	7	9	11
LC 75W 24V IP67 L EXC UNV	< 15	< 12	< 10	< 7	< 5	< 3

277 V, 60 Hz:

Type	THD	3	5	7	9	11
LC 75W 24V IP67 L EXC UNV	< 15	< 12	< 10	< 7	< 5	< 3

Acc. to 61000-3-2. Harmonics < 5 mA or < 0.6 % (whatever is greater) of the input current are not considered for calculation of THD.

5. Functions

5.1 Short-circuit behaviour

In case of a short circuit on the secondary side (LED) the LED driver switches off. After elimination of the short-circuit fault the LED driver will recover automatically.

5.2 No-load operation

The LED driver will not be damaged in the no-load operation. A voltage of 25.2V DC is permanent at the output.

5.3 Over load protection

If the maximum load is exceeded by a defined internal limit, the LED driver enter hiccup modus. After elimination of the overload fault the LED driver will recover automatically.

5.4 Over temperature protection

Over temperature protection will be activated for $t_c > 90^\circ\text{C}$. The Driver is shot down when over temperature protection triggered. Auto-recovery when fault condition removed.

6. Miscellaneous

6.1 Insulation and electric strength testing of luminaires

Electronic devices can be damaged by high voltage. This has to be considered during the routine testing of the luminaires in production.

According to UL 8750 (informative only!) each luminaire should be submitted to an insulation test with 500 V_{DC}. The dielectric withstand test equipment shall employ a transformer of 500-VA or larger capacity and have a variable output voltage that is essentially sinusoidal or continuous direct current. The applied potential is to be increased from zero at a substantially uniform rate until the required test level is reached, and is to be held at that level for 1 minute.

As an alternative, UL8750 (informative only!) describes a test of the electrical strength with 2V AC + 1000V (or 1.414 x V DC). To avoid damage to the electronic devices this test must not be conducted.

6.2 Conditions of use and storage

Humidity: 10 % up to max. 95 %, not condensed (max. 56 days/year at 95 %)

Storage temperature: -40 °C up to max. +85 °C

The devices have to be within the specified temperature range (ta) before they can be operated.

The LED driver is declared as inbuilt LED controlgear, meaning it is intended to be used within a luminaire enclosure.

If the product is used outside a luminaire, the installation must provide suitable protection for people and environment (e.g. in illuminated ceilings).

6.3 Additional information

Additional technical information at www.tridonic.com → Technical Data

Lifetime declarations are informative and represent no warranty claim. No warranty if device was opened.