

**Driver LC 75W 100–400mA 1-10V Ip EXC**

excite 1–10V series

**Product description**

- \_ Constant current LED driver for luminaire installation
- \_ Dimmable via 1 ... 10 V interface
- \_ Dimming range 10 – 100 % (Depending on load, for details refer to chapter 4.7 Dimming in data sheet.)
- \_ For luminaires of protection class I and protection class II
- \_ Adjustable output current between 100 and 400 mA via ready2mains Programmer or I-SELECT 2 plugs
- \_ Max. output power 75 W
- \_ Up to 94 % efficiency
- \_ Nominal lifetime up to 100,000 h
- \_ 5 years guarantee (conditions at <https://www.tridonic.com/manufacturer-guarantee-conditions>)

**Housing properties**

- \_ Low profile metal casing with white cover
- \_ Type of protection IP20

**Interfaces**

- \_ ready2mains configuration
- \_ 1 ... 10 V dimming interface
- \_ Terminal blocks: 0° push terminals

**Functions**

- \_ Adjustable output current in 1-mA-steps (ready2mains, I-SELECT 2)
- \_ Dimmable via 1 ... 10 V interface
- \_ Protective features (overtemperature, short-circuit, overload, no-load, input voltage range)
- \_ Intelligent Voltage Guard (overvoltage and undervoltage monitoring)
- \_ Suitable for emergency escape lighting systems acc. to EN 50172

**Benefits**

- \_ Application-oriented operating window for maximum compatibility
- \_ Best energy savings due to high efficiency and dimming via 1 ... 10 V interface
- \_ Flexible configuration via ready2mains and I-SELECT 2
- \_ Reliability proven by lifetime up to 100,000 h and 5 years guarantee (conditions at <https://www.tridonic.com/manufacturer-guarantee-conditions>)

**Typical applications**

- \_ For linear/area lighting in office applications

**Website**

<http://www.tridonic.com/28001807>

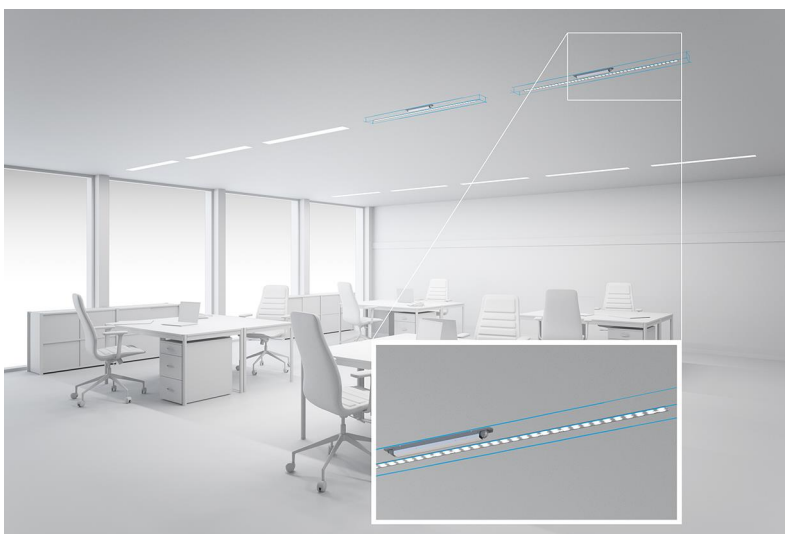

Spotlights



Downlights



Linear



Area



Floor | Wall



Free-standing



Street



Decorative



High bay

**Driver LC 75W 100–400mA 1-10V Ip EXC**

excite 1–10V series

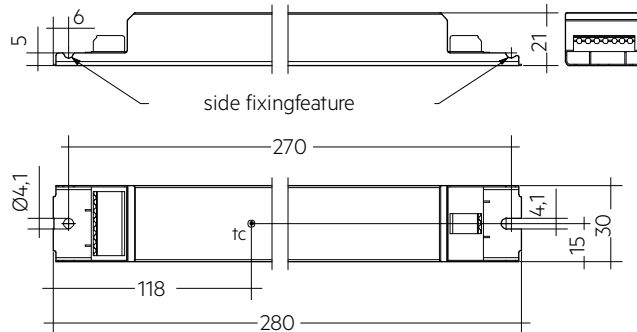
**Ordering data**

Type	Article number	Packaging, carton	Packaging, pallet	Weight per pc.
LC 75W 100-400mA 1-10V Ip EXC	28001807	10 pc(s).	960 pc(s).	0.189 kg

**Technical data**

Rated supply voltage	220 – 240 V
AC voltage range	198 – 264 V
DC voltage range	176 – 280 V
Mains frequency	0 / 50 / 60 Hz
Overvoltage protection	320 V AC, 48 h
Typ. rated current (at 230 V, 50 Hz, full load) <sup>①②</sup>	350 mA
Typ. current (220 V, 0 Hz, full load, 100 % dimming level) <sup>②③</sup>	360 mA
Leakage current (at 230 V, 50 Hz, full load) <sup>①②</sup>	< 250 $\mu$ A
Max. input power	80.9 W
Typ. efficiency (at 230 V, 50 Hz, full load) <sup>②</sup>	94 %
$\lambda$ (at 230 V, 50 Hz, full load) <sup>①</sup>	0.99
Typ. input current in no-load operation	24 mA
Typ. input power in no-load operation	0.6 W
In-rush current (peak / duration)	25.8 A / 280 $\mu$ s
THD (at 230 V, 50 Hz, full load) <sup>①</sup>	< 10 %
Starting time (at 230 V, 50 Hz, full load) <sup>①</sup>	< 500 ms
Starting time (DC mode)	< 500 ms
Switchover time (AC/DC) <sup>④</sup>	< 0.2 s
Turn off time (at 230 V, 50 Hz, full load)	< 50 ms
Output current tolerance <sup>①⑤</sup>	$\pm$ 5 %
Max. output current peak (non-repetitive)	$\leq$ output current + 35 %
Output LF current ripple (< 120 Hz)	$\pm$ 5 %
Output P_ST_LM (at full load)	$\leq$ 1
Output SVM (at full load)	$\leq$ 0.4
Max. output voltage (U-OUT)	250 V
Dimming range <sup>⑥</sup>	10 – 100 %
Mains surge capability (between L - N)	1 kV
Mains surge capability (between L/N - PE)	2 kV
Burst / surge peaks output side against PE	2 kV
Type of protection	IP20
Lifetime	up to 100,000 h
Guarantee (conditions at <a href="http://www.tridonic.com">www.tridonic.com</a> )	5 Year(s)
Dimensions L x W x H	280 x 30 x 21 mm

**Approval marks****Standards**

EN 55015, EN 60929, EN 61000-3-2, EN 61000-3-3, EN 61347-1, EN 61347-2-13, EN 62384, EN 61547, according to EN 50172, according to EN 60598-2-22

## Specific technical data

Type	Output current <sup>①</sup>	Min. output voltage	Max. output voltage	Max. output power	Typ. power consumption (at 230 V, 50 Hz, full load)	Typ. current consumption (at 230 V, 50 Hz, full load)	t <sub>c</sub> point max.	Ambient temperature T <sub>a</sub>	I-SELECT 2 resistor value <sup>⑧</sup>
LC 75W 100-400mA 1-10V Ip EXC	100 mA	50 V	220 V	22.0 W	24.3 W	114 mA	75 °C	-25 ... +65 °C	-
LC 75W 100-400mA 1-10V Ip EXC	125 mA	50 V	220 V	27.5 W	30.3 W	139 mA	75 °C	-25 ... +65 °C	40.00 kΩ
LC 75W 100-400mA 1-10V Ip EXC	150 mA	50 V	220 V	33.0 W	34.3 W	156 mA	75 °C	-25 ... +65 °C	33.33 kΩ
LC 75W 100-400mA 1-10V Ip EXC	175 mA	50 V	220 V	38.5 W	41.9 W	188 mA	75 °C	-25 ... +65 °C	28.57 kΩ
LC 75W 100-400mA 1-10V Ip EXC	200 mA	50 V	220 V	44.0 W	48.4 W	215 mA	75 °C	-25 ... +65 °C	25.00 kΩ
LC 75W 100-400mA 1-10V Ip EXC	225 mA	50 V	220 V	49.5 W	53.8 W	238 mA	80 °C	-25 ... +60 °C	22.22 kΩ
LC 75W 100-400mA 1-10V Ip EXC	250 mA	50 V	220 V	55.0 W	58.8 W	260 mA	80 °C	-25 ... +60 °C	20.00 kΩ
LC 75W 100-400mA 1-10V Ip EXC	275 mA	50 V	220 V	60.5 W	64.8 W	285 mA	80 °C	-25 ... +60 °C	18.18 kΩ
LC 75W 100-400mA 1-10V Ip EXC	300 mA	50 V	220 V	66.0 W	70.7 W	311 mA	80 °C	-25 ... +60 °C	16.67 kΩ
LC 75W 100-400mA 1-10V Ip EXC	325 mA	50 V	220 V	71.5 W	76.5 W	336 mA	75 °C	-25 ... +55 °C	15.38 kΩ
LC 75W 100-400mA 1-10V Ip EXC	350 mA	50 V	214 V	75.0 W	80.6 W	353 mA	75 °C	-25 ... +55 °C	14.29 kΩ
LC 75W 100-400mA 1-10V Ip EXC	375 mA	50 V	200 V	75.0 W	80.9 W	355 mA	75 °C	-25 ... +55 °C	13.33 kΩ
LC 75W 100-400mA 1-10V Ip EXC	400 mA	50 V	188 V	75.0 W	80.6 W	354 mA	75 °C	-25 ... +55 °C	0.00 kΩ

① Valid at 100 % dimming level.

② Depending on the selected output current.

③ Valid for Drivers with „DC new“ on the label. For old version typ. current (220 V, 0 Hz, full load, 50 % dimming level) is 173 mA.

④ Valid for immediate change of power supply type otherwise the starting time is valid.

⑤ Output current is mean value.

⑥ The min. achievable dimming level depends on the connected load. For details refer to chapter 4.7 Dimming in data sheet.

⑦ The table only lists a number of possible operating points but does not cover each single point. The output current can be set within the total value range in 1-mA-steps.

⑧ Not compatible with I-SELECT (generation 1). Calculated resistor value.

## I-SELECT 2 PLUG PRE / EXC

Accessory

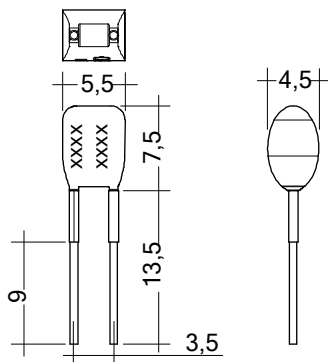
**Product description**

- \_ Ready-for-use resistor to set output current value
- \_ Compatible with LED driver featuring I-select 2 interface; not compatible with I-SELECT (generation 1)
- \_ Resistor is base insulated
- \_ Resistor power 0.25 W
- \_ Current tolerance  $\pm 2\%$  additional to output current tolerance
- \_ Compatible with LED driver series PRE and EXC

**Example of calculation**

- \_  $R [k\Omega] = 5 V / I_{out} [mA] \times 1000$
- \_ E96 resistor value used
- \_ Resistor value tolerance  $\leq 1\%$ ; resistor power  $\geq 0.1 W$ ; base insulation necessary
- \_ When using a resistor value beyond the specified range, the output current will automatically be set to the minimum value (resistor value too big), respectively to the maximum value (resistor value too small)

**Website**

<http://www.tridonic.com/28001101>

**Ordering data**

Type	Article number	Colour	Marking	Current	Resistor value	Packaging, bag	Weight per pc.
I-SELECT 2 PLUG 125MA BL	28001101	Blue	0125 mA	125 mA	40.20 k $\Omega$	10 pc(s).	0.001 kg
I-SELECT 2 PLUG 150MA BL	28001102	Blue	0150 mA	150 mA	33.20 k $\Omega$	10 pc(s).	0.001 kg
I-SELECT 2 PLUG 175MA BL	28001103	Blue	0175 mA	175 mA	28.70 k $\Omega$	10 pc(s).	0.001 kg
I-SELECT 2 PLUG 200MA BL	28001104	Blue	0200 mA	200 mA	24.90 k $\Omega$	10 pc(s).	0.001 kg
I-SELECT 2 PLUG 225MA BL	28001105	Blue	0225 mA	225 mA	22.10 k $\Omega$	10 pc(s).	0.001 kg
I-SELECT 2 PLUG 250MA BL	28001106	Blue	0250 mA	250 mA	20.00 k $\Omega$	10 pc(s).	0.001 kg
I-SELECT 2 PLUG 275MA BL	28001107	Blue	0275 mA	275 mA	18.20 k $\Omega$	10 pc(s).	0.001 kg
I-SELECT 2 PLUG 300MA BL	28001108	Blue	0300 mA	300 mA	16.50 k $\Omega$	10 pc(s).	0.001 kg
I-SELECT 2 PLUG 325MA BL	28001109	Blue	0325 mA	325 mA	15.40 k $\Omega$	10 pc(s).	0.001 kg
I-SELECT 2 PLUG 350MA BL	28001110	Blue	0350 mA	350 mA	14.30 k $\Omega$	10 pc(s).	0.001 kg
I-SELECT 2 PLUG 375MA BL	28001111	Blue	0375 mA	375 mA	13.30 k $\Omega$	10 pc(s).	0.001 kg
I-SELECT 2 PLUG 400MA BL	28001112	Blue	0400 mA	400 mA	12.40 k $\Omega$	10 pc(s).	0.001 kg
I-SELECT 2 PLUG MAX BL	28001099	Blue	MAX	MAX	0.00 k $\Omega$	10 pc(s).	0.001 kg

## 1. Standards

EN 55015

EN 60929 Annex E

EN 61000-3-2

EN 61000-3-3

EN 61347-1

EN 61347-2-13

EN 62384

EN 61547

According to EN 50172 for use in central battery systems

According to EN 60598-2-22 suitable for emergency lighting installations

## 2. Thermal details and life-time

### 2.1 Expected life-time

#### Expected life-time

Type	Output current	ta	40 °C	50 °C	55 °C	60 °C
100 – 200 mA		tc	50 °C	60 °C	65 °C	70 °C
		Life-time	> 100,000 h	> 100,000 h	75,000 h	50,000 h
LC 75W 100-400mA 1-10V Ip EXC	> 200 – 300 mA	tc	60 °C	70 °C	75 °C	–
		Life-time	> 100,000 h	75,000 h	50,000 h	–
	> 300 – 400 mA	tc	60 °C	70 °C	75 °C	–
		Life-time	> 100,000 h	75,000 h	50,000 h	–

The LED Driver is designed for a life-time stated above under reference conditions and with a failure probability of less than 10 %.

The relation of tc to ta temperature depends also on the luminaire design.

If the measured tc temperature is approx. 5 K below tc max., ta temperature should be checked and eventually critical components (e.g. ELCAP) measured. Detailed information on request.

## 3. Installation / wiring

### 3.1 Circuit diagram

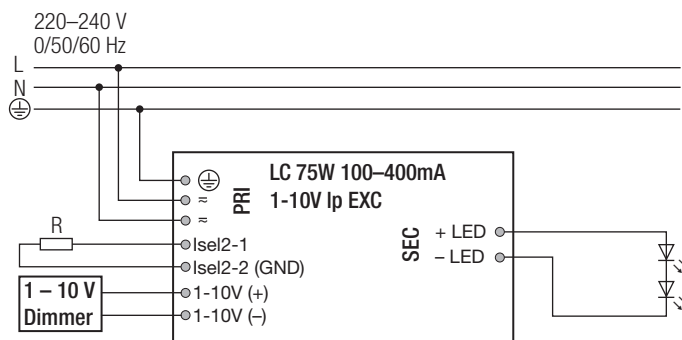

### 3.2 Wiring type and cross section

Solid wire with a cross section of 0.5 – 1.5 mm<sup>2</sup>. Strip 8 – 9 mm of insulation from the cables to ensure perfect operation of terminals.

LED module/LED Driver/supply

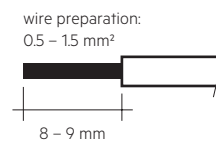

### 3.3 Loose wiring

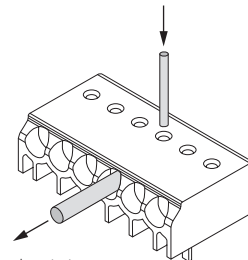

Loosen wire through twisting and pulling or using a Ø 1mm release tool

**3.4 Wiring guidelines**

- The cables should be run separately from the mains connections and mains cables to ensure good EMC conditions.
- The LED wiring should be kept as short as possible to ensure good EMC. The max. secondary cable length is 2 m (4 m circuit).
- Secondary switching is not permitted.
- The LED Driver has no inverse-polarity protection on the secondary side. Wrong polarity can damage LED modules with no inverse-polarity protection.
- Wrong wiring of the LED Driver can lead to malfunction or irreparable damage.

**3.5 Hot plug-in**

Hot plug-in is not supported due to residual output voltage of > 0 V. If a LED load is connected, the device has to be restarted before the output will be activated again. This can be done via mains reset or via interface ready2mains.

**3.6 Earth connection**

The earth connection is conducted as protection earth (PE). If the LED Driver will be earthed, protection earth (PE) has to be used. There is no earth connection required for the functionality of the LED Driver. Earth connection is recommended to improve following behaviour:

- Electromagnetic interferences (EMI)
- Transmission of mains transients to the LED output

In general it is recommended to earth the LED Driver if the LED module is mounted on earthed luminaire parts respectively heat sinks and thereby representing a high capacity against earth.

**3.7 I-select 2 resistors connected via cable**

For details see:  
[http://www.tridonic.com/com/en/download/technical/LCA\\_PRE\\_LC\\_EXC\\_ProductManual\\_en.pdf](http://www.tridonic.com/com/en/download/technical/LCA_PRE_LC_EXC_ProductManual_en.pdf).

**4. Electrical values**

**4.1 Operating window**

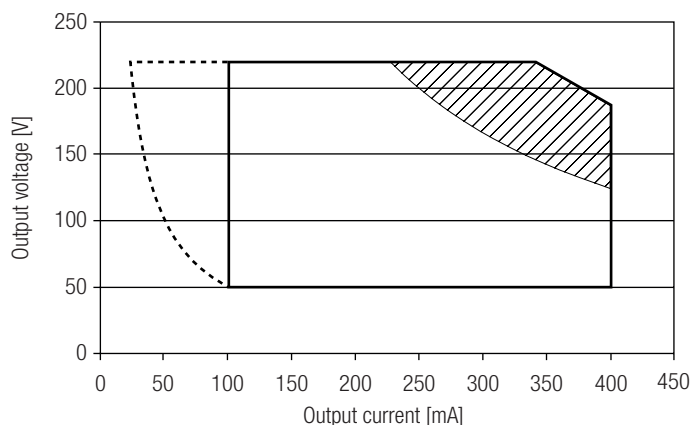

- Operating window 100 %
- - - - - Operating window dimmed
- ▨ LED modules having their non-dimmed operating point within this area can be dimmed down to 15 % light level. For loads outside this area, the achievable minimum dimming level is higher.

Make sure that the LED Driver is operated within the given window under all operating conditions. Special attention needs to be paid at dimming and DC emergency operation as the forward voltage of the connected LED modules varies with the dimming level, due to the implemented amplitude dimming technology. Coming below the specified minimum output voltage of the LED Driver may cause the device to shut-down. See chapter "6.8 DC emergency operation" for more information.

**4.2 Efficiency vs load**

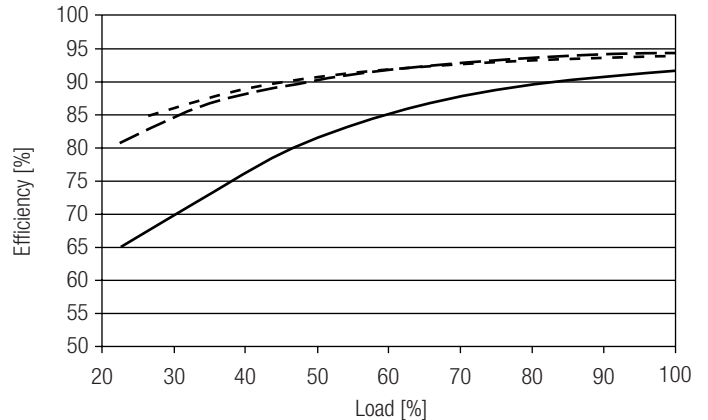

**4.3 Power factor vs load**

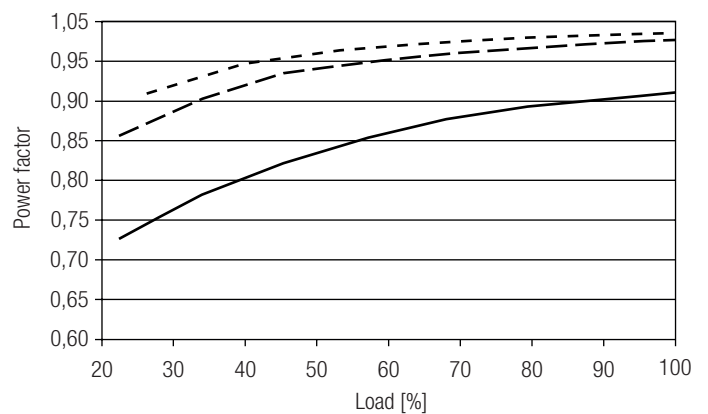

**4.4 THD vs load**

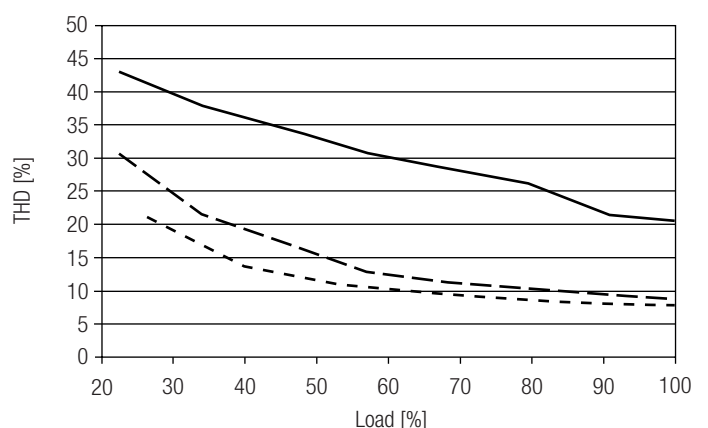

- 100 mA
- - - - - 250 mA
- · - · - 400 mA

100 % load corresponds to the max. output power (full load) according to the table on page 2.

#### 4.5 Maximum loading of automatic circuit breakers

Automatic circuit breaker type	C10	C13	C16	C20	B10	B13	B16	B20	Inrush current	
Installation Ø	1.5 mm <sup>2</sup>	1.5 mm <sup>2</sup>	2.5 mm <sup>2</sup>	2.5 mm <sup>2</sup>	1.5 mm <sup>2</sup>	1.5 mm <sup>2</sup>	2.5 mm <sup>2</sup>	2.5 mm <sup>2</sup>	$I_{max}$	time
<b>LC 75W 100-400mA 1-10V Ip EXC</b>	10	21	26	25	10	13	16	21	25.8 A	280 µs

Calculation uses typical values from ABB series S200 as a reference.

Actual values may differ due to used circuit breaker types and installation environment.

#### 4.6 Harmonic distortion in the mains supply (at 230 V / 50 Hz and full load) in %

	THD	3.	5.	7.	9.	11.
<b>LC 75W 100-400mA 1-10V Ip EXC</b>	<10	<7	<2	<3	<2	<2

#### 4.7 Dimming

Dimming range 10 to 100%

The minimum achievable dimming level depends on the connected load.

The operating window shows the minimum reachable power in dimmed state. For loads below the max. output power, the minimum dimming level can be higher.

To determine the minimum dimming level for a certain load carefully read the operating window.

For further information please refer to your Tridonic sales contact.

#### 4.8 Dimming characteristics

##### Control input (1 – 10 V)

Control input open	max. dimming level
Control input short-circuited	min. dimming level
Interface current range	400 – 500 µA
Max. permitted input voltage	± 16 V
Voltage range dimming	1 – 10 V <sup>Ⓞ</sup>
Input voltage < 1 V	min. dimming level <sup>Ⓞ</sup>
Input voltage > 10 V	max. dimming level <sup>Ⓞ</sup>

<sup>Ⓞ</sup> See graph below (at full load):

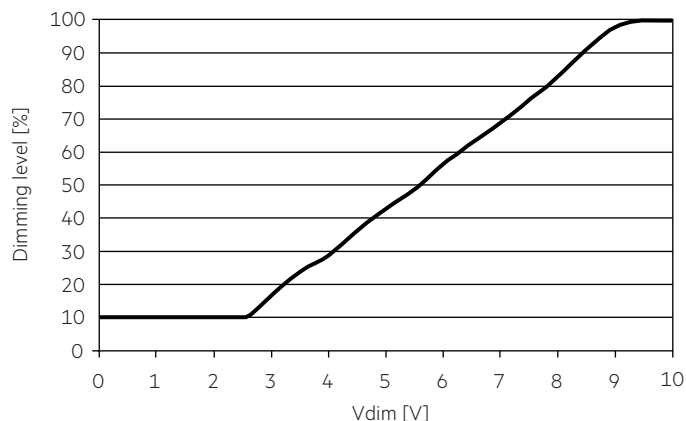

## 5. Interfaces / communication

### 5.1 Control input ready2mains (L, N)

The digital ready2mains protocol is modulated onto the mains signal which is wired to the mains terminal (L and N).

## 6. Functions

### 6.1 Function: adjustable current

The output current of the LED Driver can be adjusted in a certain range. For adjustment there are two options available.

Option 1: I-select 2

By inserting a suitable resistor or third party resistor into the I-select 2 interface, the current value can be adjusted. The relationship between output current and resistor value can be found in the chapter "Accessories I-SELECT 2 Plugs".



Please note that the resistor values for I-select 2 are not compatible with I-select (generation 1). Installation of an incorrect resistor may cause irreparable damage to the LED module(s).

Resistors for the main output current values can be ordered from Tridonic (see accessories).

Option 2: ready2mains

Adjustment is done by the ready2mains Programmer and the corresponding configuration software (see ready2mains documentation).



Current adjustment can only be done five times over ready2mains. To program the LED Driver a connected load is necessary that is within the operating window of the LED Driver.

The priority for current adjustment methods is I-select 2 followed by ready2mains (lowest priority).

## 6.2 ready2mains – configuration

The ready2mains interface enables the configuration of the mostly used parameters via the mains wiring.

In the case of EXC LED Driver, it is the LED output current as well as an optional lockbit to prevent any accidental configuration at a later stage.

The configuration is done via the ready2mains Programmer, either directly at the Programmer itself or via a respective software tool. For details on the configuration via ready2mains see the technical information of the Programmer and its tools.

## 6.3 Short-circuit behaviour

In case of a short-circuit at the LED output the LED output is switched off. After restart of the LED Driver the output will be activated again. The restart can either be done via mains reset or via interface ready2mains.

## 6.4 No-load operation

The LED Driver will not be damaged in no-load operation. The output will be deactivated and is therefore free of voltage. If a LED load is connected the device has to be restarted before the output will be activated again.

## 6.5 Overload protection

If the output voltage range is exceeded the LED Driver turns off the LED output. After restart of the LED Driver the output will be activated again. The restart can either be done via mains reset or via interface ready2mains.

## 6.6 Overtemperature protection

The LED Driver is protected against temporary thermal overheating. If the temperature limit is exceeded the output current of the LED module(s) is reduced. The temperature protection is activated approx. +5 °C above  $t_c$  max (see page 2). On DC operation this function is deactivated to fulfill emergency requirements.

## 6.7 DC emergency operation

The LED Driver is designed to operate on DC voltage and pulsed DC voltage. For a reliable operation, make sure that also in DC emergency operation the LED Driver is run within the specified conditions as stated in chapter "4.1 Operating window".

Light output level in DC operation (EOF<sub>x</sub>): 50 % (cannot be adjusted)

The voltage-dependent input current of Driver incl. LED module is depending on the used load.

The nominal voltage-dependent no-load current of Driver (without or defect LED module) is for:

AC: < 21 mA (at 230 V)

DC: < 11 mA (at 275 – 186 V, 0 Hz)

## 7. Miscellaneous

### 7.1 Isolation and electric strength testing of luminaires

Electronic devices can be damaged by high voltage. This has to be considered during the routine testing of the luminaires in production.

According to IEC 60598-1 Annex Q (informative only!) or ENEC 303-Annex A, each luminaire should be submitted to an isolation test with 500 V<sub>DC</sub> for one second. This test voltage should be connected between the interconnected phase and neutral terminals and the earth terminal. The isolation resistance must be at least 2 MΩ.

As an alternative, IEC 60598-1 Annex Q describes a test of the electrical strength with 1500 V<sub>AC</sub> (or 1.414 x 1500 V<sub>DC</sub>). To avoid damage to the electronic devices this test must not be conducted.

### 7.2 Conditions of use and storage

Environmental conditions: 5 % up to max. 85 %,  
not condensed  
(max. 56 days/year at 85 %)

Storage temperature: -40 °C up to max. +80 °C

The devices have to be acclimatised to the specified temperature range (ta) before they can be operated.

### 7.3 Additional information

Additional technical information at [www.tridonic.com](http://www.tridonic.com) → Technical Data

Guarantee conditions at [www.tridonic.com](http://www.tridonic.com) → Services

Life-time declarations are informative and represent no warranty claim. No warranty if device was opened.