

Driver LC 60W 1050mA fixC SC ADV

advanced series



With strain-relief (see accessory)

Product description

- _ Fixed output LED driver
- _ Can be either used built-in or independent with clip-on strain-relief (see accessory)
- _ Independent LED driver with cable clamps
- _ Constant current LED driver
- _ For luminaires of protection class I and protection class II
- _ Temperature protection as per EN 61347-2-13 C5e
- _ Output current 1,050 mA
- _ Max. output power 60 W
- _ Nominal lifetime up to 50,000 h
- _ 5 years guarantee (conditions at <https://www.tridonic.com/en/int/services/manufacturer-guarantee-conditions>)

Housing properties

- _ Casing: polycarbonate, white
- _ Type of protection IP20

Functions

- _ Overtemperature protection
- _ Overload protection
- _ Short-circuit protection
- _ No-load protection
- _ Burst protection voltage 1 kV
- _ Surge protection voltage 1 kV (L to N)
- _ Surge protection voltage 2 kV (L/N to earth)

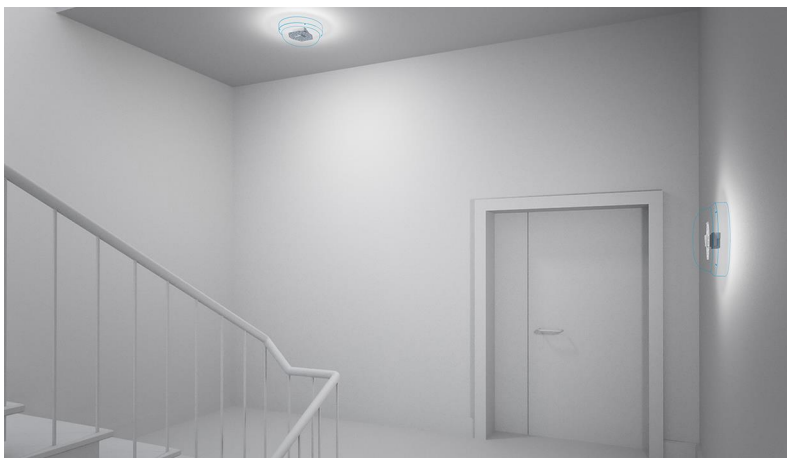
Website
<http://www.tridonic.com/28002489>

Linear



High bay



Decorative



Downlights



Spotlights



Free-standing



Area



Floor | Wall



Street

Driver LC 60W 1050mA fixC SC ADV

advanced series

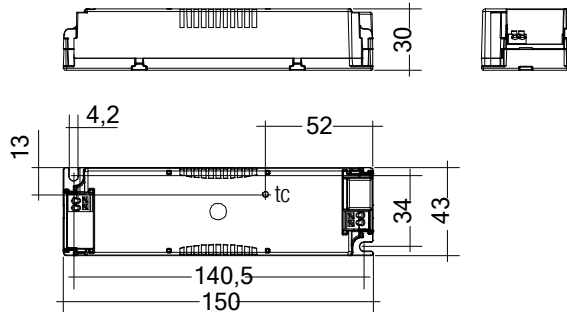

Ordering data

| Type | Article number | Packaging, carton | Packaging, pallet | Weight per pc. |
|---------------------------|----------------|-------------------|-------------------|----------------|
| LC 60W 1050mA fixC SC ADV | 28002489 | 15 pc(s). | 1,440 pc(s). | 0.154 kg |

Technical data

| | |
|---|------------------|
| Rated supply voltage | 220 – 240 V |
| AC voltage range | 198 – 264 V |
| Mains frequency | 50 / 60 Hz |
| Overvoltage protection | 320 V AC, 1 h |
| THD (at 230 V, 50 Hz, full load) | < 10 % |
| Output current tolerance ^① | ± 7,5 % |
| Typ. current ripple (at 230 V, 50 Hz, full load) | ± 5 % |
| Output P _{ST_LM} (at full load) | ≤ 1 |
| Output SVM (at full load) | ≤ 0,4 |
| Max. output voltage (U-OUT) | 70 V |
| Starting time (at 230 V, 50 Hz, full load) | ≤ 0,5 s |
| Turn off time (at 230 V, 50 Hz, full load) | ≤ 0,2 s |
| Hold on time at power failure (output) | 0 s |
| Ambient temperature t _a | -20 ... +50 °C |
| Ambient temperature t _a (at lifetime 50,000 h) | 40 °C |
| Storage temperature t _s | -40 ... +80 °C |
| Lifetime | up to 50,000 h |
| Guarantee (conditions at www.tridonic.com) | 5 Year(s) |
| Dimensions L x W x H | 150 x 43 x 30 mm |
| Dimensions with strain-relief L x W x H | 210 x 43 x 30 mm |

Approval marks



Standards

EN 55015, EN 61000-3-2, EN 61000-3-3, EN 61347-1, EN 61347-2-13, EN 61547, EN 62384

Specific technical data

| Type | Output current ^① | Input current (at 230 V, 50 Hz, full load) | Input power (at 230 V, 50 Hz, full load) | Output power range | λ at full load | Efficiency at full load ^② | λ over full operating range (min.) | Efficiency at min. load ^③ | Min. forward voltage | Max. forward voltage | Max. output peak current at full load ^④ | Max. output peak current at min. load ^⑤ | Max. casing temperature t _c |
|---------------------------|-----------------------------|--|--|--------------------|----------------|--------------------------------------|------------------------------------|--------------------------------------|----------------------|----------------------|--|--|--|
| LC 60W 1050mA fixC SC ADV | 1,050 mA | 0,284 A | 66 W | 32,5 – 60 W | 0,95 | 90 % | 0,9C | 85 % | 31 V | 57 V | 1,242 mA | 1,367 mA | 75 °C |

① Output current is mean value.

② Test result at 230 V, 50 Hz.

③ The trend between min. and full load is linear.

Strain-relief set 43x30mm

Accessory



Product description

- _ Optional strain-relief set for independent applications
- _ Transforms the LED driver into a fully class II compatible LED driver (e.g. ceiling installation)
- _ Easy and tool-free mounting to the LED driver, screwless cable-clamp channels for long strain-relief (30 x 43 x 30 mm)
- _ With screws for short strain-relief (15 x 34 x 30 mm)
- _ Overall length = length L (LED driver) + 2 x 30 mm (long strain-relief set), 2 x 15 mm (short strain-relief) or long and short strain-relief any combination
- _ Standard SC (L = 30 mm) available as non-pre-assembled and pre-assembled
- _ Short SC (L = 15 mm) only pre-assembled available

Website

<http://www.tridonic.com/28001168>

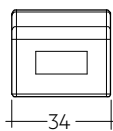
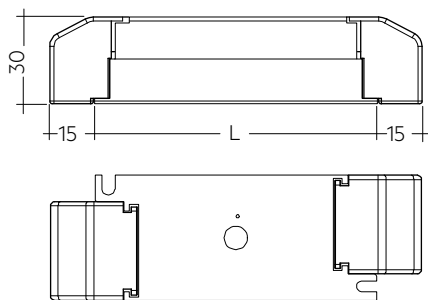

Permissible cable jacket diameter:
3 – 9 mm

Ordering data

| Type | Article number | Packaging, carton ^① | Packaging, outer box | Weight per pc. |
|-----------------------------------|----------------|--------------------------------|----------------------|----------------|
| ACU SC 43x30mm CLIP-ON SR SET | 28001168 | 10 pc(s). | 500 pc(s). | 0.018 kg |
| ACU SC 43x30mm CLIP-ON SR SET 300 | 28001351 | 300 pc(s). | 300 pc(s). | 0.033 kg |
| ACU SC 30x43x30mm CLIP-ON SR PA | 28001699 | 10 pc(s). | 500 pc(s). | 0.015 kg |
| ACU SC 15x43x30mm CLIP-ON SR PA | 28001574 | 10 pc(s). | 1,200 pc(s). | 0.012 kg |

Approval marks



^① 28001168: A carton of 10 pcs. is equal to 10 sets, each with 2 strain-reliefs parts. 28001351: A carton of 300 pcs. is equal to 300 sets, each with 2 strain-reliefs parts. 28001699 + 28001574: A carton contains exactly 10 pcs. strain-reliefs (no sets).

1. Standards

EN 55015
 EN 61000-3-2
 EN 61000-3-3
 EN 61347-1
 EN 61347-2-13
 EN 61547
 EN 62384

1.1 Glow-wire test

according to EN 61347-1 with increased temperature of 850 °C passed.

2. Thermal details and lifetime

2.1 Expected lifetime

| Expected lifetime | | | |
|---------------------------|--------------------|--------------------|--------------------|
| Type | t_a | 40 °C | 50 °C |
| LC 60W 1050mA fixC SC ADV | t_c [Ⓢ] | 65 °C [Ⓢ] | 75 °C [Ⓢ] |
| | Lifetime | 50,000 h | 30,000 h |

[Ⓢ] Test result at max. output voltage.

[Ⓢ] The t_c temperature could be higher with different output voltages (refer to the t_c vs. output voltage diagram for the details).

The LED drivers are designed for a lifetime stated above under reference conditions and with a failure probability of less than 10 %.

The relation of t_c to t_a temperature depends also on the luminaire design. If the measured t_c temperature is approx. 5 K below t_c max., t_a temperature should be checked and eventually critical components (e.g. ELCAP) measured. Detailed information on request.

3. Installation / wiring

3.1 Circuit diagram

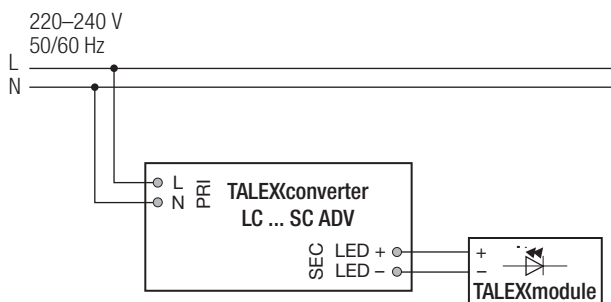

Recommendation to check glowing at standby in combination with class I luminaires.

3.2 Wiring type and cross section

For wiring use stranded wire with ferrules or solid wire from 0.5–1.5 mm². Strip 8.5–9.5 mm of insulation from the cables to ensure perfect operation of the push-wire terminals. Use one wire for each terminal connector only.

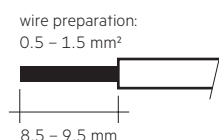

3.3 Release of the wiring

Press down the “push button” and remove the cable from front.

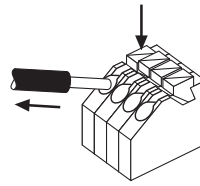

3.4 Fixing conditions when using as independent Driver with Clip-On

Dry, acidfree, oilfree, fatfree. It is not allowed to exceed the maximum ambient temperature (t_a) stated on the device. Minimum distances stated below are recommendations and depend on the actual luminaire. Is not suitable for fixing in corner.

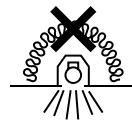
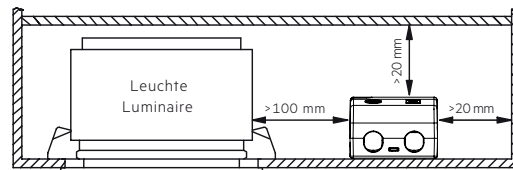

Device not suitable for covering with thermally insulating material according to IEC 60598-1 Ed.9

3.5 Wiring guidelines

- All connections must be kept as short as possible to ensure good EMI behaviour.
- Mains leads should be kept apart from LED driver and other leads (ideally 5 – 10 cm distance)
- Max. length of output wires is 2 m.
- To comply with the EMC regulations run the secondary wires (LED module) in parallel.
- Secondary switching is not permitted.
- Incorrect wiring can damage LED modules.
- To avoid damage of the Driver, the wiring must be protected against short circuits to earth (sharp edged metal parts, metal cable clips, louver, etc.).

3.6 Replace LED module

1. Mains off
2. Remove LED module
3. Wait for 10 seconds
4. Connect LED module again

Hot plug-in or secondary switching of LEDs is not permitted and may cause a very high current to the LEDs.

3.7 Installation instructions

The LED module and all contact points within the wiring must be sufficiently insulated against 1 kV surge voltage. Air and creepage distance must be maintained.

3.8 Mounting of device

Max. torque for fixing: 0.5 Nm/M4

4. Electrical values

4.1 Diagrams LC 60W 1050mA fixC SC ADV

4.1.1 Efficiency vs load

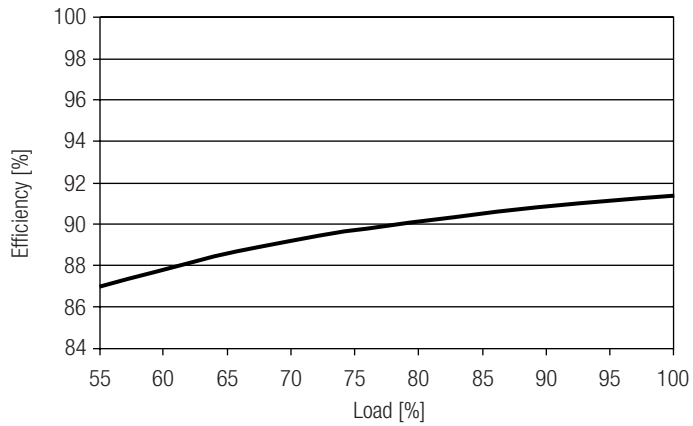

4.1.4 Input current vs load

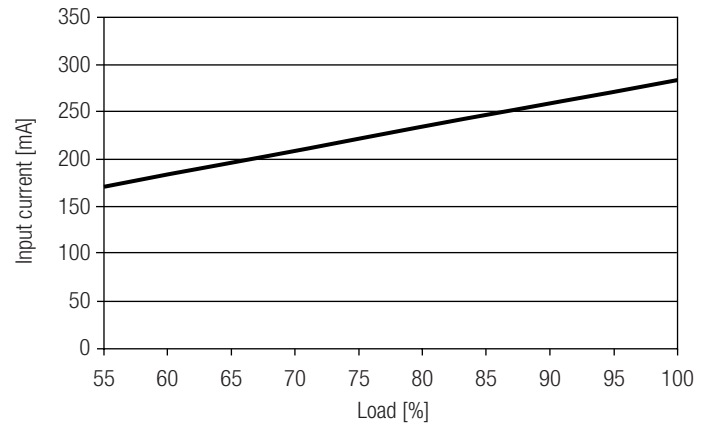

4.1.2 Power factor vs load

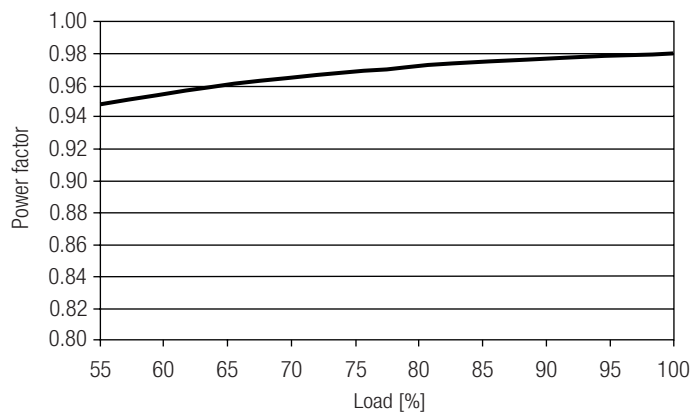

4.1.5 THD vs load

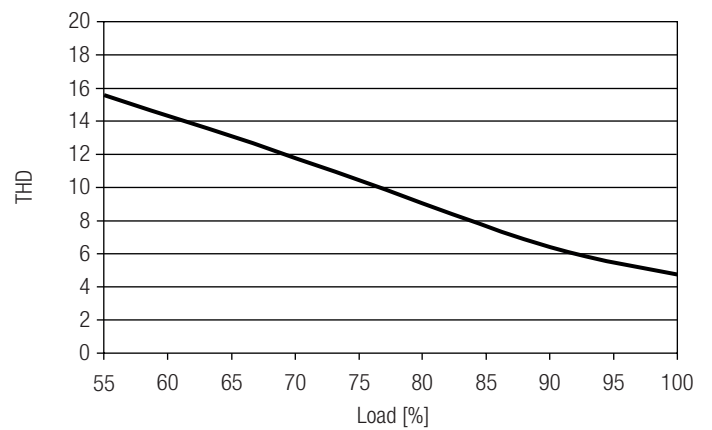

4.1.3 Input power vs load

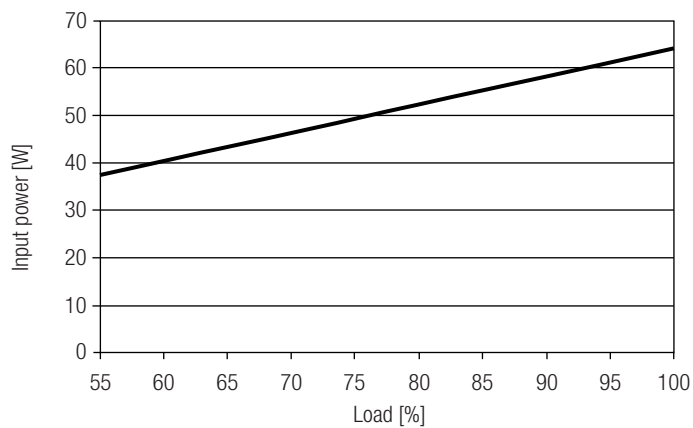

4.1.6 tc vs output voltage

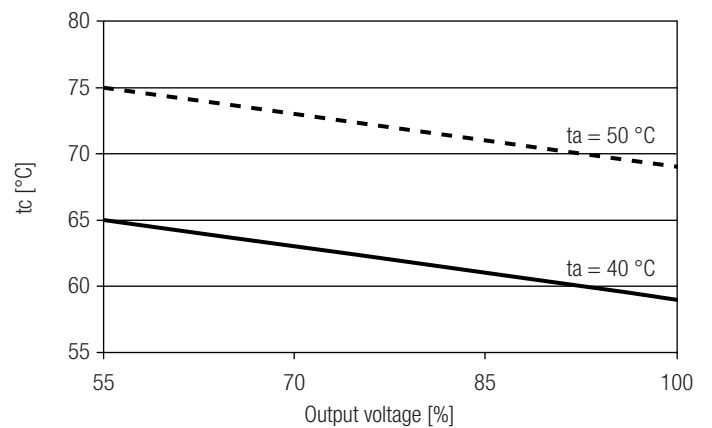

4.2 Maximum loading of automatic circuit breakers in relation to inrush current

| Automatic circuit breaker type | C10 | C13 | C16 | C20 | B10 | B13 | B16 | B20 | Inrush current | |
|----------------------------------|---------------------|---------------------|---------------------|---------------------|---------------------|---------------------|---------------------|---------------------|----------------|--------|
| Installation Ø | 1.5 mm ² | 1.5 mm ² | 1.5 mm ² | 2.5 mm ² | 1.5 mm ² | 1.5 mm ² | 1.5 mm ² | 2.5 mm ² | I_{max} | Time |
| LC 60W 1050mA fixC SC ADV | 15 | 22 | 29 | 35 | 8 | 11 | 15 | 18 | 25 A | 250 µs |

These are max. values calculated out of inrush current! Please consider not to exceed the maximum rated continuous current of the circuit breaker. Calculation uses typical values from ABB series S200 as a reference. Actual values may differ due to used circuit breaker types and installation environment.

4.3 Harmonic distortion in the mains supply (at 230 V / 50 Hz and full load) in %

| | THD | 3. | 5. | 7. | 9. | 11. |
|----------------------------------|------|-----|-----|-----|-----|-----|
| LC 60W 1050mA fixC SC ADV | < 10 | < 5 | < 4 | < 4 | < 4 | < 3 |

5. Functions

5.1 Short-circuit behaviour

In case of a short circuit on the secondary side (LED) the LED driver switches off. After elimination of the short-circuit fault the LED driver will recover automatically.

5.2 No-load operation

The LED driver will work in a pulsed light output mode to limit the output voltage lower than 60 V which allows the application to be able to work safely when LED string opens due to a failure.

5.3 Overload protection

If the maximum load is exceeded by a defined internal limit, the LED driver reduces the LED output current. If the output voltage is exceeded by a certain degree the driver will start working in a pulsed light output mode. After elimination of the overload the nominal operation is restored automatically.

5.4 Overtemperature protection

The LED driver will reduce the LED output current or it works in a pulsed light output mode if the temperature reaches a certain degree.

5.5 Output over voltage protection

The LED driver will work in a pulsed light output mode to limit the output voltage lower than 60 V, even in fault conditions.

6. Miscellaneous

6.1 Insulation and electric strength testing of luminaires

Electronic devices can be damaged by high voltage. This has to be considered during the routine testing of the luminaires in production.

According to IEC 60598-1 Annex Q (informative only!) or ENEC 303-Annex A, each luminaire should be submitted to an insulation test with 500 V_{DC} for 1 second. This test voltage should be connected between the interconnected phase and neutral terminals and the earth terminal. The insulation resistance must be at least 2 MΩ.

As an alternative, IEC 60598-1 Annex Q describes a test of the electrical strength with 1500 V_{AC} (or 1.414 x 1500 V_{DC}). To avoid damage to the electronic devices this test must not be conducted.

6.2 Conditions of use and storage

Humidity: 5% up to max. 85%,
not condensed
(max. 56 days/year at 85%)

Storage temperature: -40 °C up to max. +80 °C

The devices have to be within the specified temperature range (t_a) before they can be operated.

The LED driver is declared as inbuilt LED controlgear, meaning it is intended to be used within a luminaire enclosure. If the product is used outside a luminaire, the installation must provide suitable protection for people and environment (e.g. in illuminated ceilings).

6.3 Maximum number of switching cycles

All LED driver are tested with 50,000 switching cycles.

6.4 Additional information

Additional technical information at www.tridonic.com → Technical Data

Lifetime declarations are informative and represent no warranty claim. No warranty if device was opened.