

Driver LC 40W 900/1050mA fixC SC SNC2

essence series

**Product description**

- _ Fixed output LED driver
- _ Can be either used built-in or independent with clip-on strain-relief (see accessory)
- _ Independent LED driver with cable clamps
- _ Constant current LED driver
- _ For luminaires of protection class I and protection class II
- _ Temperature protection as per EN 61347-2-13 C5e
- _ Output current 900 or 1,050 mA
- _ Max. output power 40 W
- _ Nominal lifetime up to 50,000 h
- _ 5 years guarantee (Conditions at www.tridonic.com)

Housing properties

- _ Casing: polycarbonate, white
- _ Type of protection IP20

Functions

- _ Overload protection
- _ Short-circuit protection
- _ No-load protection
- _ Burst protection voltage 1 kV
- _ Surge protection voltage 1 kV (L to N)
- _ Surge protection voltage 2 kV (L/N to earth)

Typical applications

- _ For spot light and downlight in retail and hospitality applications
- _ For panel light and area light in office and education application

Website

<http://www.tridonic.com/87500744>

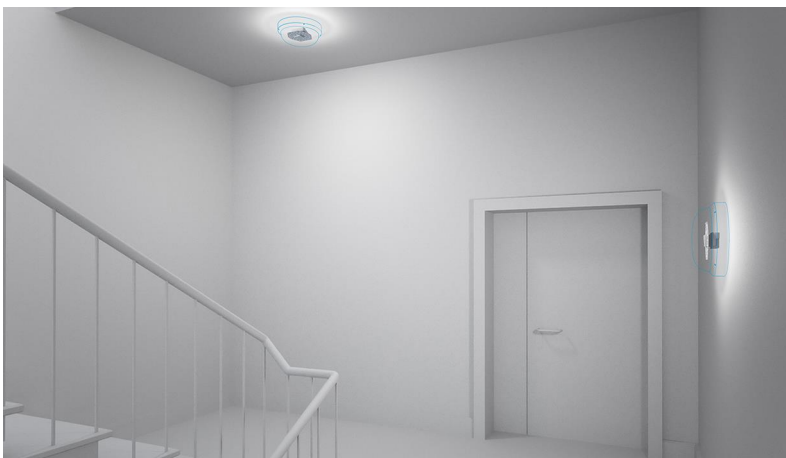

Spotlights



Downlights



Linear



Area



Floor | Wall



Free-standing



Street



Decorative



High bay

Driver LC 40W 900/1050mA fixC SC SNC2

essence series

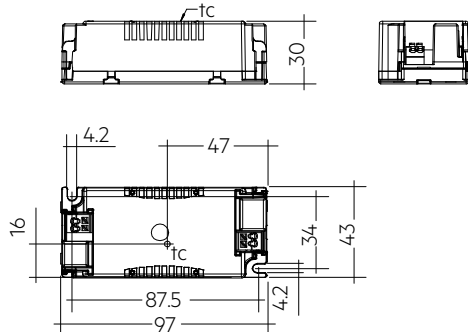

Ordering data

Type	Article number	Packaging, carton	Packaging, low volume	Packaging, high volume	Weight per pc.
LC 40/900/45 fixC SC SNC2	87500744	40 pc(s).	880 pc(s).	4,400 pc(s).	0.095 kg
LC 40/1050/39 fixC SC SNC2	87500745	40 pc(s).	880 pc(s).	4,400 pc(s).	0.095 kg

Technical data

Rated supply voltage	220 – 240 V
AC voltage range	198 – 264 V
Mains frequency	50 / 60 Hz
Overvoltage protection	320 V AC, 1 h
THD (at 230 V, 50 Hz, full load)	< 20 %
Output current tolerance ^①	± 7.5 %
Typical output LF current ripple at full load ^②	± 25 %
Starting time (at 230 V, 50 Hz, full load)	≤ 0.5 s
Turn off time (at 230 V, 50 Hz, full load)	≤ 0.5 s
Hold on time at power failure (output)	0 s
Ambient temperature <i>t</i> _a	-20 ... +50 °C
Ambient temperature <i>t</i> _a (at lifetime 50,000 h)	40 °C
Storage temperature <i>t</i> _s	-40 ... +80 °C
Lifetime	up to 50,000 h
Guarantee	5 Year(s)
Dimensions L x W x H	97 x 43 x 30 mm

Approval marks



Standards

EN 55015, EN 61000-3-2, EN 61000-3-3, EN 61347-1, EN 61347-2-13, EN 61547, EN 60598-1, EN 62384

Specific technical data

Type	Output current ^①	Input current (at 230 V, 50 Hz, full load)	Max. input power	Typ. power consumption (at 230 V, 50 Hz, full load)	Output power range	λ at full load ^③	Efficiency at full load ^③	λ over full operating range (min.) ^③	Efficiency at min. load ^③	Min. forward voltage	Max. forward voltage	Max. output voltage (U-OUT)	Max. output peak current at full load ^④	Max. output peak current at min. load ^④	Max. casing temperature <i>t</i> _c
LC 40/900/45 fixC SC SNC2	900 mA	220 mA	46 W	45.0 W	24.3 – 40.5 W	0.95	90 %	0.9C	88 %	27 V	45 V	60 V	1,260 mA	1,450 mA	80 °C
LC 40/1050/39 fixC SC SNC2	1,050 mA	220 mA	47 W	45.5 W	24.2 – 41.0 W	0.95	90 %	0.9C	88 %	23 V	39 V	60 V	1,470 mA	1,700 mA	85 °C

^① Output current is mean value.^② Typical value at full load, depend on load's V-I character.^③ Test result at 230 V, 50 Hz.^④ The trend between min. and full load is linear and depend on load's V-I character.

Strain-relief set 43x30mm

Accessory



Product description

- _ Optional strain-relief set for independent applications
- _ Transforms the LED driver into a fully class II compatible LED driver (e.g. ceiling installation)
- _ Easy and tool-free mounting to the LED driver, screwless cable-clamp channels for long strain-relief (30 x 43 x 30 mm)
- _ With screws for short strain-relief (15 x 34 x 30 mm)
- _ Overall length = length L (LED driver) + 2 x 30 mm (long strain-relief set), 2 x 15 mm (short strain-relief) or long and short strain-relief any combination
- _ Standard SC (L = 30 mm) available as non-pre-assembled and pre-assembled
- _ Short SC (L = 15 mm) only pre-assembled available

Website

<http://www.tridonic.com/28001168>

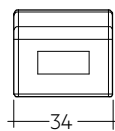
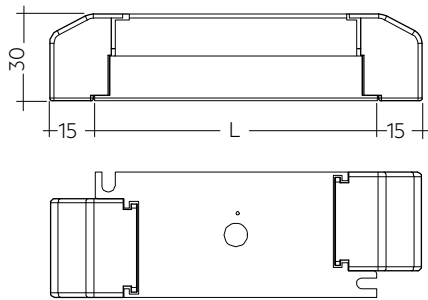

Permissible cable jacket diameter:
3 – 9 mm

Ordering data

Type	Article number	Packaging, carton ^①	Packaging, outer box	Weight per pc.
ACU SC 43x30mm CLIP-ON SR SET	28001168	10 pc(s).	500 pc(s).	0.038 kg
ACU SC 43x30mm CLIP-ON SR SET 300	28001351	300 pc(s).	300 pc(s).	0.038 kg
ACU SC 30x43x30mm CLIP-ON SR PA	28001699	10 pc(s).	500 pc(s).	0.021 kg
ACU SC 15x43x30mm CLIP-ON SR PA	28001574	10 pc(s).	1,200 pc(s).	0.010 kg

Approval marks



^① 28001168: A carton of 10 pcs. is equal to 10 sets, each with 2 strain-reliefs parts. 28001351: A carton of 300 pcs. is equal to 300 sets, each with 2 strain-reliefs parts. 28001699 + 28001574: A carton contains exactly 10 pcs. strain-reliefs (no sets).

1. Standards

EN 55015
 EN 61000-3-2
 EN 61000-3-3
 EN 61347-1
 EN 61347-2-13
 EN 61547
 EN 60598-1
 EN 62384

1.1 Glow-wire test

according to EN 61347-1 with increased temperature of 850 °C passed.

2. Thermal details and lifetime

2.1 Expected lifetime

Expected lifetime			
Type	t_a	40 °C [®]	50 °C [®]
LC 40/900/45 fixC SC SNC2	t_c	70 °C [®]	80 °C [®]
	Lifetime	50,000 h	30,000 h
LC 40/1050/39 fixC SC SNC2	t_c	75 °C [®]	85 °C [®]
	Lifetime	50,000 h	30,000 h

[®] Test result at max. output voltage.

The LED drivers are designed for a lifetime stated above under reference conditions and with a failure probability of less than 10 %.

The relation of t_c to t_a temperature depends also on the luminaire design. If the measured t_c temperature is approx. 5 K below t_c max., t_a temperature should be checked and eventually critical components (e.g. ELCAP) measured. Detailed information on request.

3. Installation / wiring

3.1 Circuit diagram

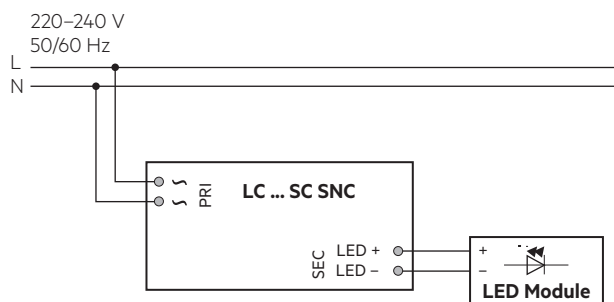

3.2 Wiring type and cross section

For wiring use stranded wire with ferrules or solid wire from 0.5–1.5 mm². Strip 8.5–9.5 mm of insulation from the cables to ensure perfect operation of the push-wire terminals. Use one wire for each terminal connector only.

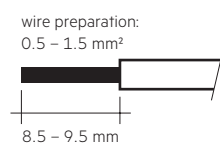

3.3 Release of the wiring

Press down the “push button” and remove the cable from front.

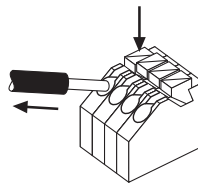

3.4 Fixing conditions when using as independent Driver with Clip-On

Dry, acidfree, oilfree, fatfree. It is not allowed to exceed the maximum ambient temperature (t_a) stated on the device. Minimum distances stated below are recommendations and depend on the actual luminaire. Is not suitable for fixing in corner.

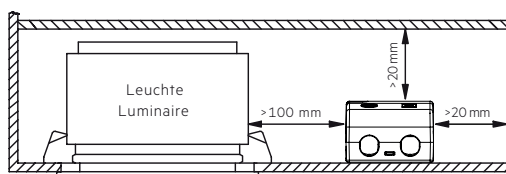

3.5 Wiring guidelines

- All connections must be kept as short as possible to ensure good EMI behaviour.
- Mains leads should be kept apart from LED driver and other leads (ideally 5 – 10 cm distance)
- Max. length of output wires is 2 m.
- To comply with the EMC regulations run the secondary wires (LED module) in parallel.
- Secondary switching is not permitted.
- Incorrect wiring can damage LED modules.
- To avoid the damage of the Driver, the wiring must be protected against short circuits to earth (sharp edged metal parts, metal cable clips, louver, etc.).

3.6 Replace LED module

1. Mains off
2. Remove LED module
3. Wait for 20 seconds
4. Connect LED module again

Hot plug-in or secondary switching of LEDs is not permitted and may cause a very high current to the LEDs.

3.7 Installation instructions

The LED module and all contact points within the wiring must be sufficiently insulated against 3 kV surge voltage. Air and creepage distance must be maintained.

3.8 Mounting of device

Max. torque for fixing: 0.5 Nm/M4

4. Electrical values

4.1 Diagrams LC 40W 900mA fixC SC SNC2

4.1.1 Efficiency vs load

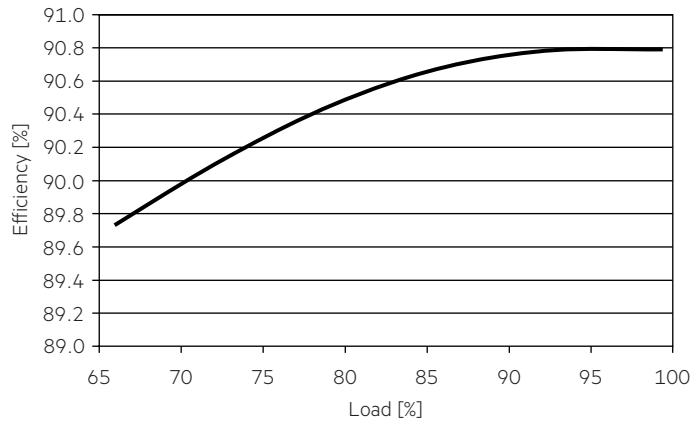

4.1.4 Input current vs load

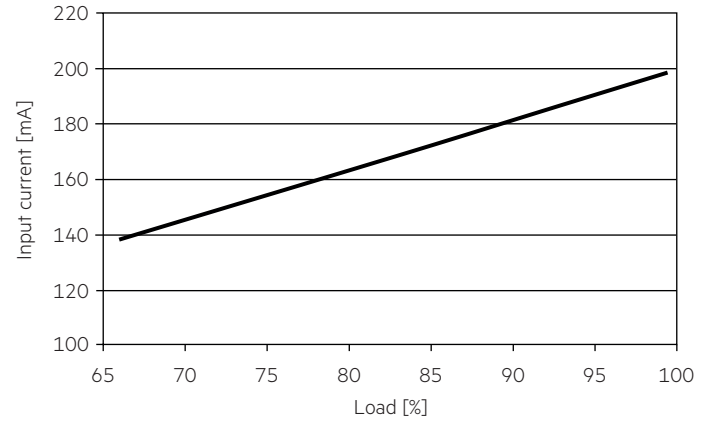

4.1.2 Power factor vs load

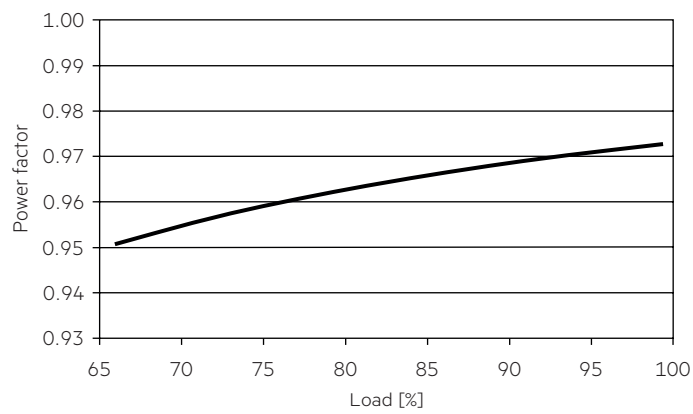

4.1.5 THD vs load

THD without harmonic < 5 mA (0.6 %) of the input current:

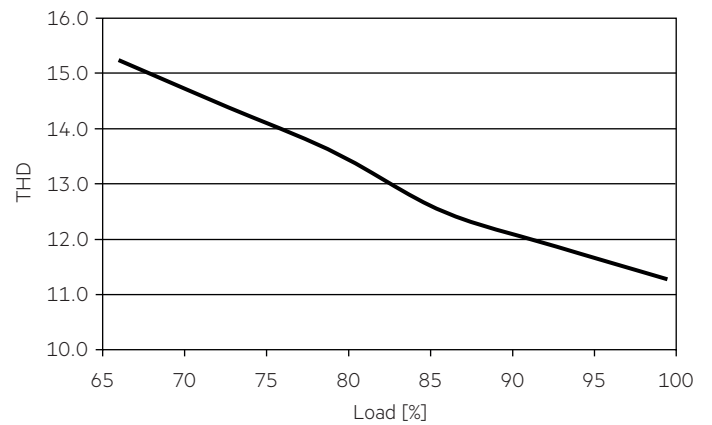

4.1.3 Input power vs load

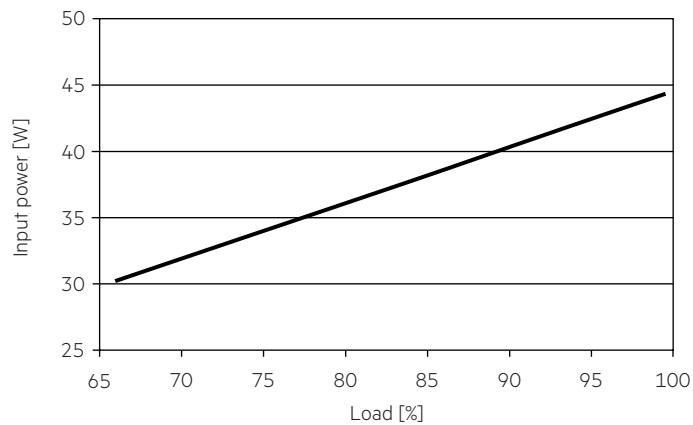

4.2 Diagrams LC 40W 1050mA fixC SC SNC2

4.2.1 Efficiency vs load

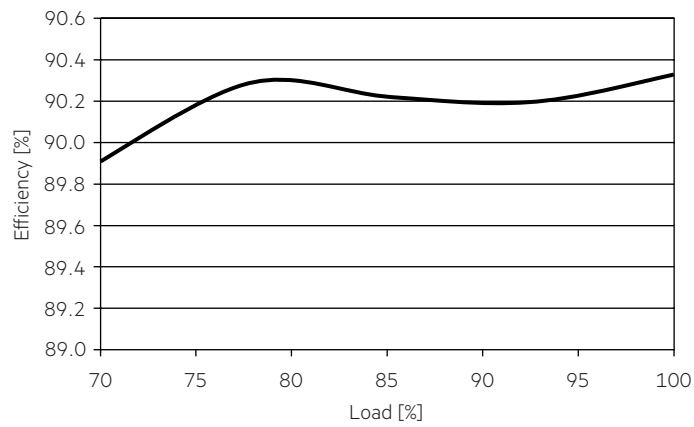

4.2.4 Input current vs load

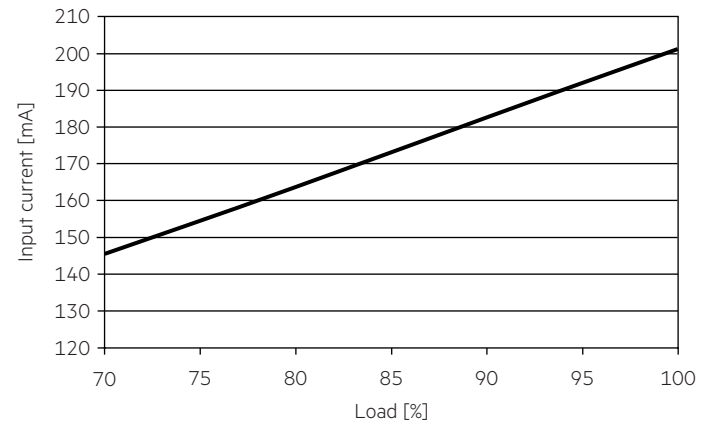

4.2.2 Power factor vs load

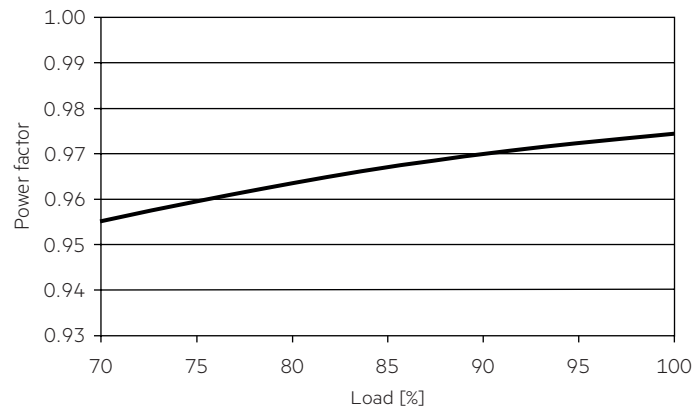

4.2.5 THD vs load

THD without harmonic < 5 mA (0.6 %) of the input current:

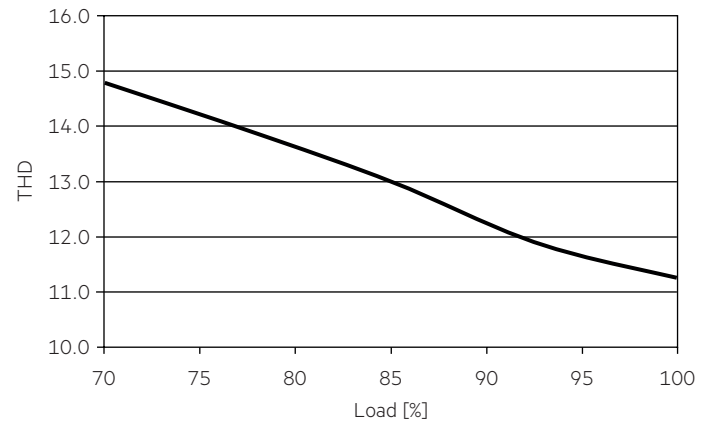

4.2.3 Input power vs load

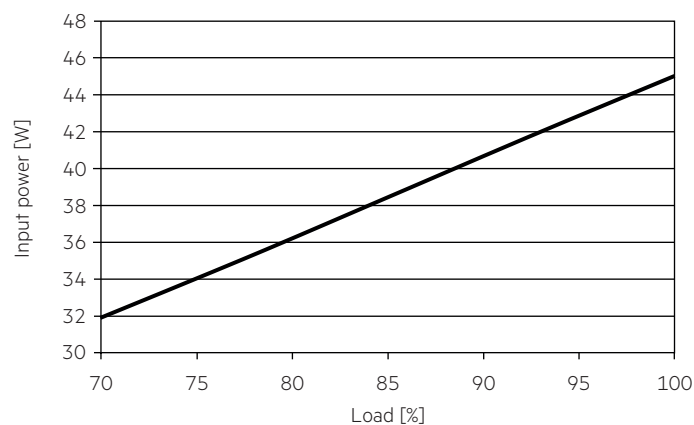

4.3 Maximum loading of automatic circuit breakers in relation to inrush current

Automatic circuit breaker type	C10	C13	C16	C20	B10	B13	B16	B20	Inrush current	
Installation Ø	1.5 mm ²	1.5 mm ²	1.5 mm ²	2.5 mm ²	1.5 mm ²	1.5 mm ²	1.5 mm ²	2.5 mm ²	I _{max}	Time
LC 40/900/45 fixC SC SNC2	35	50	65	75	35	50	65	75	10 A	100 µs
LC 40/1050/39 fixC SC SNC2	35	50	65	75	35	50	65	75	10 A	100 µs

These are max. values calculated out of continuous current running the device on full load.
There is no limitation due to inrush current.
If load is smaller than full load for calculation only continuous current has to be considered.

4.4 Harmonic distortion in the mains supply (at 230 V / 50 Hz and full load) in %

	THD	3.	5.	7.	9.	11.
LC 40/900/45 fixC SC SNC2	< 15	< 13	< 5	< 5	< 5	< 3
LC 40/1050/39 fixC SC SNC2	< 15	< 15	< 5	< 4	< 3	< 3

Acc. to 61000-3-2. Harmonics < 5 mA or < 0.6 % (whatever is greater) of the input current are not considered for calculation of THD.

5. Functions

5.1 Short-circuit behaviour

In case of a short circuit on the secondary side (LED) the LED driver switches into hic-cup mode. After elimination of the short-circuit fault the LED driver will recover automatically.

5.2 No-load operation

The LED driver works in burst working mode to provide a constant output voltage regulation which allows the application to be able to work safely when LED string opens due to a failure.

5.3 Overload protection

If the maximum load is exceeded by a defined internal limit, the LED driver will protect itself and LED may flicker. After elimination of the overload, the nominal operation is restored automatically.

6. Miscellaneous

6.1 Insulation and electric strength testing of luminaires

Electronic devices can be damaged by high voltage. This has to be considered during the routine testing of the luminaires in production.

According to IEC 60598-1 Annex Q (informative only!) or ENEC 303-Annex A, each luminaire should be submitted to an insulation test with 500 V_{DC} for 1 second. This test voltage should be connected between the interconnected phase and neutral terminals and the earth terminal.
The insulation resistance must be at least 2 MΩ.

As an alternative, IEC 60598-1 Annex Q describes a test of the electrical strength with 1500 V_{AC} (or 1.414 x 1500 V_{DC}). To avoid damage to the electronic devices this test must not be conducted.

6.2 Conditions of use and storage

Humidity: 5 % up to max. 85 %, not condensed (max. 56 days/year at 85 %)

Storage temperature: -40 °C up to max. +80 °C

The devices have to be within the specified temperature range (t_a) before they can be operated.

The LED driver is declared as inbuilt LED controlgear, meaning it is intended to be used within a luminaire enclosure.

If the product is used outside a luminaire, the installation must provide suitable protection for people and environment (e.g. in illuminated ceilings).

6.3 Maximum number of switching cycles

All LED driver are tested with 50,000 switching cycles.

6.4 Additional information

Additional technical information at www.tridonic.com → Technical Data

Lifetime declarations are informative and represent no warranty claim.
No warranty if device was opened.