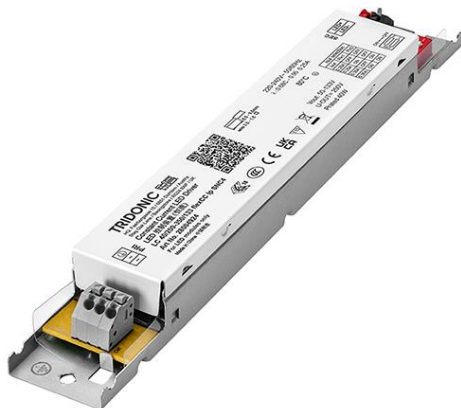

Driver LC 40W 200-350mA flexCC Ip SNC4

essence series

**Product description**

- _ LED Constant current LED driver for luminaire installation
- _ For class I luminaires
- _ Temperature protection as per EN 61347-2-13 C5e
- _ Selectable fixed output current 350, 300, 250 and 200 mA
- _ Max. output power 40 W
- _ Up to 90 % efficiency
- _ Nominal lifetime up to 50,000 h
- _ 3 years guarantee (conditions at

<https://www.tridonic.com/en/int/services/manufacturer-guarantee-conditions>)

Housing properties

- _ Casing: metal, white
- _ Type of protection IP20

Functions

- _ Overload protection
- _ Short-circuit protection
- _ No-load protection

Website

<http://www.tridonic.com/28004924>

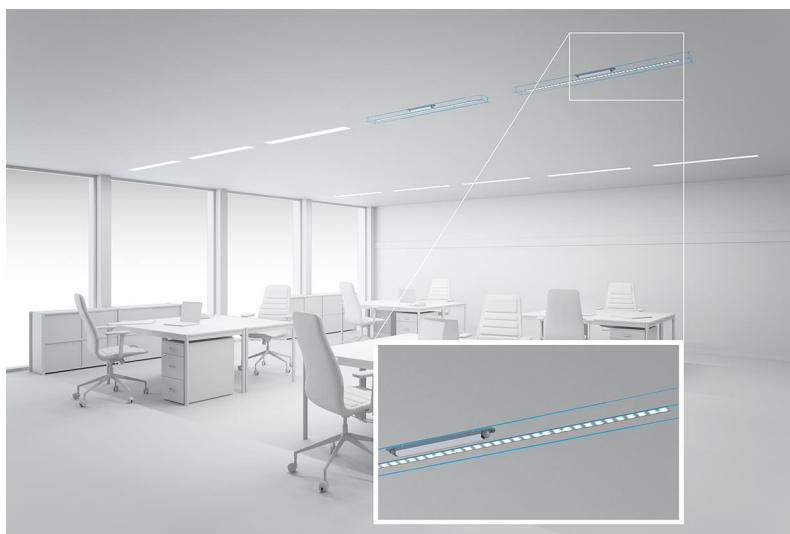

Linear



High bay



Decorative



Downlights



Spotlights



Free-standing



Area



Floor | Wall



Street

Driver LC 40W 200-350mA flexCC Ip SNC4

essence series

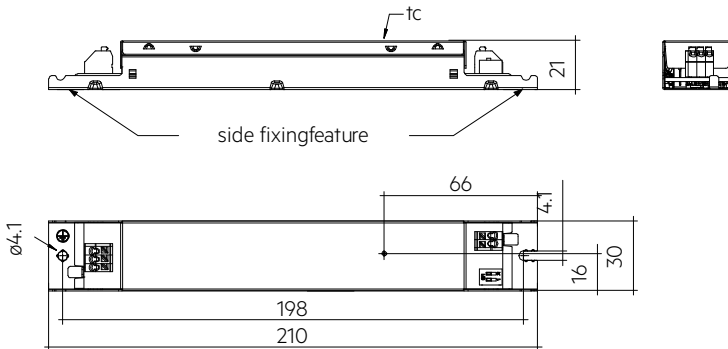

Ordering data

Type	Article number	Packaging, carton	Packaging, pallet	Weight per pc.
LC 40/200-350/133 flexCC Ip SNC4	28004924	50 pc(s).	4,200 pc(s).	0.12 kg

Technical data

Rated supply voltage	220 – 240 V
AC voltage range	198 – 264 V
Max. input current (at 230 V, 50 Hz, full load) ^①	0.25 A
Leakage current (at 230 V, 50 Hz, full load)	< 450 μ A
Mains frequency	50 / 60 Hz
Overvoltage protection	320 V AC, 48 h
Max. output power	40 W
Output power range	10 – 43.8 W
Typ. efficiency (at 230 V, 50 Hz, full load) ^①	90 %
λ over full operating range (max.)	0.95
λ over full operating range (min.)	0.68C
Output current tolerance ^②	\pm 7.5 %
Max. output voltage (U-OUT)	250 V
THD (at 230 V, 50 Hz, full load) ^①	< 20 %
Max. peak output current at full load ^①	378 mA
Output LF current ripple (< 120 Hz)	\pm 5 %
Output P_ST_LM (at full load)	\leq 1
Output SVM (at full load)	\leq 0.4
Starting time (at 230 V, 50 Hz, full load)	\leq 0.5 s
Turn off time (at 230 V, 50 Hz, full load)	\leq 0.5 s
Hold on time at power failure (output)	< 0.3 s
Ambient temperature t_a (at lifetime 50,000 h)	50 °C
Storage temperature t_s	-40 ... +80 °C
Mains burst capability	1 kV
Mains surge capability (between L - N)	1 kV
Mains surge capability (between L/N - PE)	2 kV
Surge voltage at output side (against PE)	2.5 kV
Lifetime	up to 50,000 h
Guarantee (conditions at www.tridonic.com)	3 Year(s)
Dimensions L x W x H	210 x 30 x 21 mm
Hole spacing D	198 mm

Approval marks



Standards

EN 55015, EN 61000-3-2, EN 61000-3-3, EN 61347-1, EN 61347-2-13, EN 61547, EN 62384

Specific technical data

Type	Output current ^①	Min. output voltage	Max. output voltage	Max. output power	Typ. power consumption (at 230 V, 50 Hz, full load)	Typ. current consumption (at 230 V, 50 Hz, full load)	tc point max.	Ambient temperature ta	I-out select
LC 40/200-350/133 flexCC Ip SNC4	200 mA	50 V	133 V	26.6 W	27.8 W	129 mA	80 °C	-20 ... +60 °C	1=off / 2=off
LC 40/200-350/133 flexCC Ip SNC4	250 mA	50 V	133 V	33.3 W	35.4 W	161 mA	80 °C	-20 ... +60 °C	1=on / 2=off
LC 40/200-350/133 flexCC Ip SNC4	300 mA	50 V	133 V	39.9 W	42.3 W	190 mA	80 °C	-20 ... +60 °C	1=off / 2=on
LC 40/200-350/133 flexCC Ip SNC4	350 mA	50 V	114 V	40.0 W	43.5 W	195 mA	80 °C	-20 ... +60 °C	1=on / 2=on

① Test result at 350 mA.

② Test result at 25 °C.

③ Output current is mean value.

1. Standards

EN 55015
 EN 61000-3-2
 EN 61000-3-3
 EN 61347-1
 EN 61347-2-13
 EN 61547
 EN 62384

2. Thermal details and lifetime

Expected lifetime							
Type	ta	25 °C	40 °C	45 °C	50 °C	55 °C	60 °C
LC 40/200-350/133 flexCC Ip SNC4	tc	50 °C	60 °C	65 °C	70 °C	75 °C	80 °C
	Lifetime	> 50,000 h	> 50,000 h	> 50,000 h	50,000 h	42,000 h	30,000 h

The LED driver is designed for a lifetime stated above under reference conditions and with a failure probability of less than 10 %.

The relation of tc to ta temperature depends also on the luminaire design.

If the measured tc temperature is approx. 5 K below tc max., ta temperature should be checked and eventually critical components (e.g. ELCAP) measured. Detailed information on request.

3. Installation / wiring

3.1 Circuit diagram

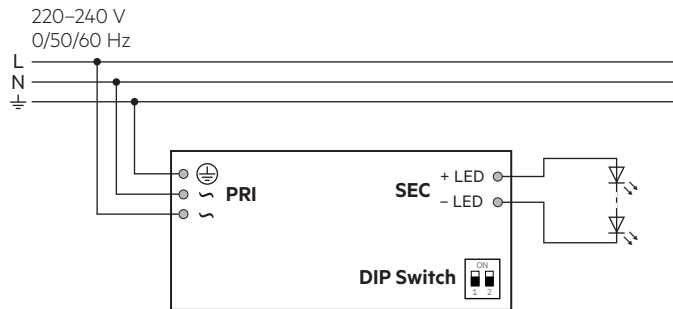

3.2 Wiring type and cross section

For wiring use stranded wire with ferrules or solid wire from 0.5 – 1.5 mm². Strip 8.5 – 9.5 mm of insulation from the cables to ensure perfect operation of the push-wire terminals (WAGO 250).

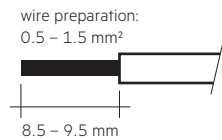

3.3 Release of the wiring

Press down the “push button” and remove the cable from front.

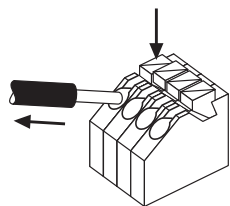

3.4 Wiring guidelines

- All connections must be kept as short as possible to ensure good EMI behaviour.
- Mains leads should be kept apart from LED driver and other leads (ideally 5 – 10 cm distance)
- Max. length of output wires is 2 m.
- Incorrect wiring can damage LED modules.
- To avoid damage of the Driver, the wiring must be protected against short circuits to earth (sharp edged metal parts, metal cable clips, louver, etc.).

3.5 Earth connection

The earth connection is conducted as protection earth (PE). The LED driver can be earthed via metal housing. Ground the LED driver with protective earth (PE).

- Electromagnetic interferences (EMI)
- Transmission of mains transients to the LED output

In general it is recommended to earth the LED driver if the LED module is mounted on earthed luminaire parts respectively heat sinks and thereby representing a high capacity against earth.

3.6 Replace LED module

1. Mains off
2. Remove LED module
3. Wait for 30 seconds
4. Connect LED module again

Hot plug-in or output switching of LEDs is not permitted and may cause a very high current to the LEDs.

3.7 Mounting of device

Max. torque for fixing: 0.5 Nm/M4

3.8 Current setting

-  Set the current by DIP switch after mains off.
Use of DIP switch only after mains off.

200 mA: Switch 1 = Off, Switch 2 = Off

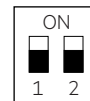

250 mA: Switch 1 = On, Switch 2 = Off

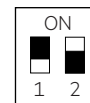

300 mA: Switch 1 = Off, Switch 2 = On

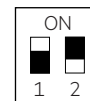

350 mA: Switch 1 = On, Switch 2 = On

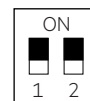

4. Electrical values

4.1 Efficiency vs load

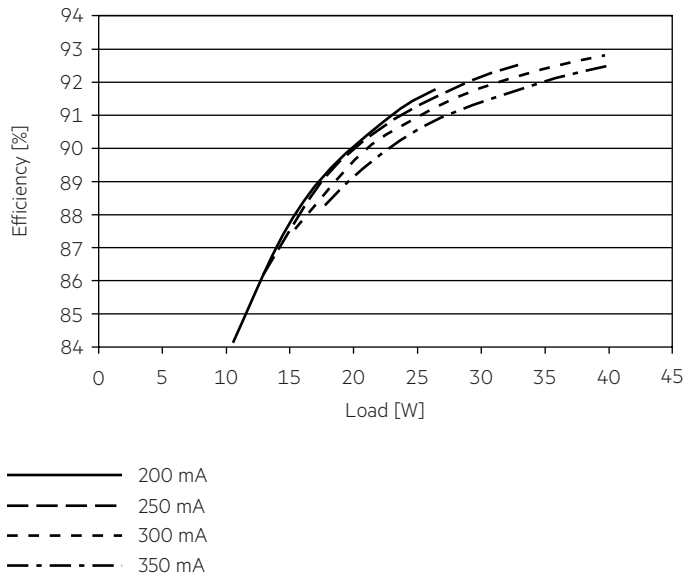

4.2 Power factor vs load

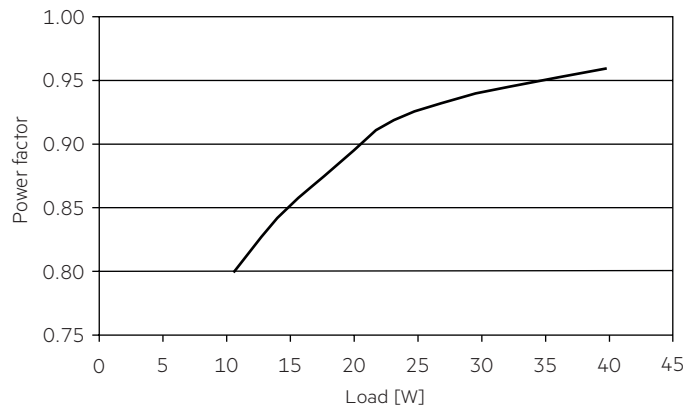

4.5 THD vs load (without harmonic < 5 mA or 0.6 % of the input current)

THD without harmonic < 5 mA (0.6 %) of the input current:

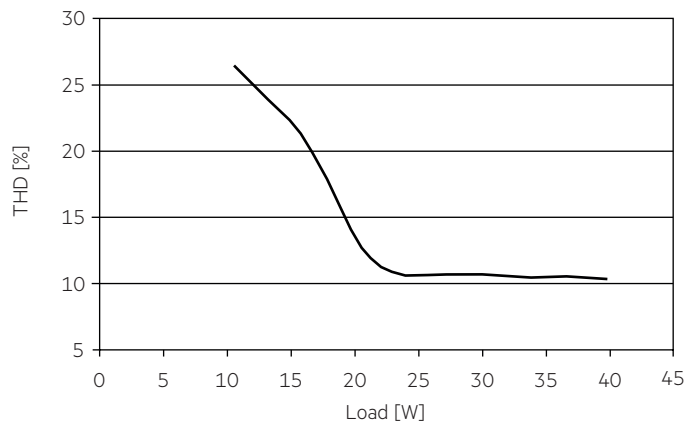

4.6 Maximum loading of automatic circuit breakers in relation to inrush current

Automatic circuit breaker type	C10	C13	C16	C20	B10	B13	B16	B20	Inrush current	
Installation Ø	1.5 mm ²	1.5 mm ²	1.5 mm ²	2.5 mm ²	1.5 mm ²	1.5 mm ²	1.5 mm ²	2.5 mm ²	I _{max}	Time
LC 40/200-350/133 flexCC Ip SNC4	39	51	63	79	20	26	32	39	15.6 A	260 µs

These are max. values calculated out of inrush current! Please consider not to exceed the maximum rated continuous current of the circuit breaker.

Calculation uses typical values from ABB series S200 as a reference.

Actual values may differ due to used circuit breaker types and installation environment.

4.7 Harmonic distortion in the mains supply (at 230 V / 50 Hz and full load) in %

	THD	3.	5.	7.	9.	11.
LC 40/200-350/133 flexCC Ip SNC4	< 12	< 10	< 7	< 5	< 4	< 3

Acc. to 61000-3-2. Harmonics < 5 mA or < 0.6 % (whatever is greater) of the input current are not considered for calculation of THD.

5. Functions

5.1 Short-circuit behaviour

In case of a short circuit on the output side (LED) the LED driver switches off. After elimination of the short-circuit fault the LED driver will recover automatically.

5.2 No-load operation

The LED driver works in burst working mode to provide a constant output voltage regulation which allows the application to be able to work safely when LED string opens due to a failure.

5.3 Overload protection

If the maximum load is exceeded by a defined internal limit, the LED driver will protect itself and LED may flicker. After elimination of the overload, the nominal operation is restored automatically.

6. Miscellaneous

6.1 Insulation and electric strength testing of luminaires

Electronic devices can be damaged by high voltage. This has to be considered during the routine testing of the luminaires in production.

According to IEC 60598-1 Annex Q (informative only!) or ENEC 303-Annex A, each luminaire should be submitted to an insulation test with 500 V_{DC} for 1 second. This test voltage should be connected between the interconnected phase and neutral terminals and the earth terminal.

The insulation resistance must be at least 2 MΩ.

As an alternative, IEC 60598-1 Annex Q describes a test of the electrical strength with 1500 V_{AC} (Or 1.414 x 1500 V_{DC}). To avoid damage to the electronic devices this test must not be conducted.

6.2 Conditions of use and storage

Humidity: 5% up to max. 85%,
not condensed
(max. 56 days/year at 85%)

Storage temperature: -40 °C up to max. +80 °C

The devices have to be within the specified temperature range (ta) before they can be operated.

The LED driver is declared as inbuilt LED controlgear, meaning it is intended to be used within a luminaire enclosure.

If the product is used outside a luminaire, the installation must provide suitable protection for people and environment (e.g. in illuminated ceilings).

6.3 Maximum number of switching cycles

All LED driver are tested with 50,000 switching cycles.

6.4 Additional information

Additional technical information at www.tridonic.com → Technical Data

Lifetime declarations are informative and represent no warranty claim. No warranty if device was opened.