

Driver LC 38W 650–1050mA 42V bDW NF SC EXC3

excite series



With strain-relief

Product description

- _ Can be integrated in Casambi systems (Casambi Ready)
- _ NEW: lumDATA (Luminaire data, Energy reporting and Diagnostics & Maintenance)
- _ Can be either used built-in or independent with clip-on strain-relief (see accessory)
- _ Forms automatically a wireless communication network with up to 250 nodes
- _ Dimming range 1 – 100 % (min. 5 mA)
- _ For luminaires of protection class I and protection class II
- _ Temperature protection as per EN 61347-2-13 C5e
- _ Adjustable output current between 650 – 1,050 mA via NFC
- _ Max. output power 38 W
- _ Up to 87 % efficiency
- _ Lowest power input on stand-by < 0.45 W
- _ Nominal lifetime up to 100,000 h
- _ 5 years guarantee (conditions at <https://www.tridonic.com/manufacturer-guarantee-conditions>)
- _ We will provide security updates for the next five years after the date of purchase of this product

Housing properties

- _ Casing: polycarbonate, white
- _ Type of protection IP20

Interfaces

- _ basicDIM Wireless
- _ Near field communication (NFC)
- _ Terminal blocks: 45° push terminals

Functions

- _ Adjustable output current in 1-mA-steps (NFC)
- _ Enhanced constant light output function (eCLO)
- _ Protective features (overtemperature, short-circuit, overload, no-load)
- _ Suitable for emergency escape lighting systems acc. to EN 50172

Benefits

- _ Flexible configuration via companionSUITE (NFC)
- _ Application-oriented operating window for maximum compatibility
- _ Best energy savings due to low stand-by losses and high efficiency
- _ In-field programming possible after installation with NFC interface

Typical applications

- _ For downlight, spotlight and decorative applications

Website

<http://www.tridonic.com/28003716>



Spotlights



Downlights



Linear



Area



Floor | Wall



Free-standing



Street



Decorative



High bay

Driver LC 38W 650–1050mA 42V bDW NF SC EXC3

excite series

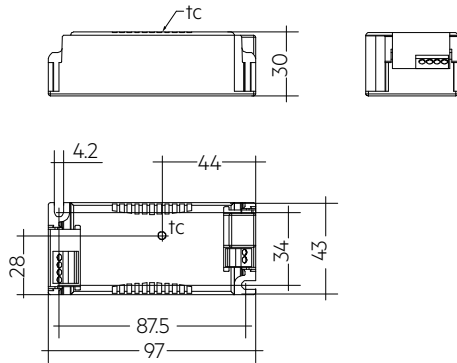
**Ordering data**

Type	Article number	Packaging, carton	Packaging, pallet	Weight per pc.
LC 38/650-1050/42 bDW NF SC EXC3	28003716	10 pc(s).	920 pc(s).	0.159 kg

Technical data

Rated supply voltage	220 – 240 V
AC voltage range	198 – 264 V
DC voltage range	176 – 280 V
Mains frequency	0 / 50 / 60 Hz
Overvoltage protection	320 V AC, 48 h
Typ. rated current (at 230 V, 50 Hz, full load) ^{①②}	196 mA
Typ. current (220 V, 0 Hz, full load, 15 % dimming level) ^②	35.4 mA
Leakage current (at 230 V, 50 Hz, full load) ^{①②}	< 250 µA
Max. input power	44.3 W
Typ. efficiency (at 230 V, 50 Hz, full load) ^②	87 %
λ (at 230 V, 50 Hz, full load) ^①	0.97
λ (over full operating range)	0.57C – 0.97
Typ. power consumption on stand-by	< 0.45 W
In-rush current (peak / duration)	5.33 A / 42 µs
THD (at 230 V, 50 Hz, full load) ^①	< 10 %
Starting time (AC mode)	< 900 ms
Starting time (DC mode)	< 500 ms
Switchover time (AC/DC) ^③	< 800 ms
Turn off time (at 230 V, 50 Hz, full load)	< 50 ms
Output current tolerance ^{①④}	± 5 %
Max. output current peak (non-repetitive)	≤ output current + 20 %
Output LF current ripple (< 120 Hz)	± 5 %
Output P_ST_LM (at full load)	≤ 1
Output SVM (at full load)	≤ 0.4
Max. output voltage (U-OUT)	60 V
Dimming range	1 – 100 % (min. 5 mA)
Mains surge capability (between L - N) ^⑤	1 kV
Mains surge capability (between L/N - PE)	2 kV
Burst protection	1 kV
Burst / surge peaks output side against PE	< 3 kV
Ambient temperature t _a	-20 ... +50 °C
Max. casing temperature t _c	87 °C
Radio transceiver operating frequencies	2.4 – 2.483 GHz
Max. output power radio transceiver (E.I. R.P.) ^⑥	< + 20 dBm
Radio protocol	Bluetooth 4.0 or 5.0 Low Energy (BLE)
Capable for mesh network	Up to 250 nodes / Standard networks and Long Range
Type of protection	IP20
Lifetime	up to 100,000 h
Guarantee (conditions at www.tridonic.com)	5 Year(s)
Dimensions L x W x H	97 x 43 x 30 mm

Approval marks**Standards**

EN 55015, EN 61000-3-2, EN 61000-3-3, EN 61000-4-4, EN 61000-4-5, EN 61347-1, EN 61347-2-13, EN 62384, EN 61547, according to EN 50172, according to EN 60598-2-22

Specific technical data

Type	Output current ^④	Min. output voltage	Max. output voltage	Max. output power	Typ. power consumption (at 230 V, 50 Hz, full load)	Typ. current consumption (at 230 V, 50 Hz, full load)
LC 38/650-1050/42 bDW NF SC EXC3	650 mA	7.5 V	42.0 V	27.3 W	32.3 W	154 mA
LC 38/650-1050/42 bDW NF SC EXC3	700 mA	7.5 V	42.0 V	29.4 W	34.9 W	166 mA
LC 38/650-1050/42 bDW NF SC EXC3	800 mA	7.5 V	42.0 V	33.6 W	39.3 W	185 mA
LC 38/650-1050/42 bDW NF SC EXC3	905 mA	7.5 V	42.0 V	38.0 W	44.2 W	207 mA
LC 38/650-1050/42 bDW NF SC EXC3	1,050 mA	7.5 V	36.2 V	38.0 W	43.6 W	196 mA

① Valid at 100 % dimming level.

② Depending on the selected output current.

③ Valid for immediate change of power supply type otherwise the starting time is valid.

④ Output current is mean value.

⑤ L-N acc. to EN 61000-4-5. 2 Ohm, 1,2/50 µs, 8/20 µs.

⑥ E.I.R.P.: Equivalent Isotropically Radiated Power.

Strain-relief set 43x30mm

Accessory



Product description

- _ Optional strain-relief set for independent applications
- _ Transforms the LED driver into a fully class II compatible LED driver (e.g. ceiling installation)
- _ Easy and tool-free mounting to the LED driver, screwless cable-clamp channels for long strain-relief (30 x 43 x 30 mm)
- _ With screws for short strain-relief (15 x 34 x 30 mm)
- _ Overall length = length L (LED driver) + 2 x 30 mm (long strain-relief set), 2 x 15 mm (short strain-relief) or long and short strain-relief any combination
- _ Standard SC (L = 30 mm) available as non-pre-assembled and pre-assembled
- _ Short SC (L = 15 mm) only pre-assembled available

Website

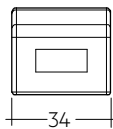
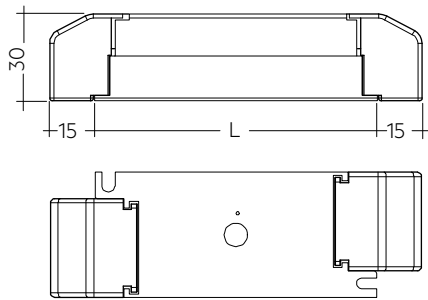
<http://www.tridonic.com/28001168>

Permissible
cable jacket
diameter:
3 – 9 mm

Ordering data

Type	Article number	Packaging, carton ^①	Packaging, outer box	Weight per pc.
ACU SC 43x30mm CLIP-ON SR SET	28001168	10 pc(s).	500 pc(s).	0.038 kg
ACU SC 43x30mm CLIP-ON SR SET 300	28001351	300 pc(s).	300 pc(s).	0.038 kg
ACU SC 30x43x30mm CLIP-ON SR PA	28001699	10 pc(s).	500 pc(s).	0.021 kg
ACU SC 15x43x30mm CLIP-ON SR PA	28001574	10 pc(s).	1,200 pc(s).	0.010 kg

Approval marks



^① 28001168: A carton of 10 pcs. is equal to 10 sets, each with 2 strain-reliefs parts. 28001351: A carton of 300 pcs. is equal to 300 sets, each with 2 strain-reliefs parts. 28001699 + 28001574: A carton contains exactly 10 pcs. strain-reliefs (no sets).

1. Standards

EN 55015
 EN 61000-3-2
 EN 61000-3-3
 EN 61000-4-4
 EN 61000-4-5
 EN 61347-1
 EN 61347-2-13
 EN 62384
 EN 61547

According to EN 50172 for use in central battery systems

According to EN 60598-2-22 suitable for emergency luminaire

1.1 Glow wire test

according to EN 61347-1 with increased temperature of 850 °C passed.

2. Thermal details and lifetime

2.1 Expected lifetime

Expected lifetime for build-in use

Type	Output current	ta	40 °C	50 °C
	650 mA	tc	66 °C	73 °C
		Lifetime	>100,000 h	>100,000 h
	> 650 – 700 mA	tc	67 °C	75 °C
		Lifetime	>100,000 h	>100,000 h
LC 38/650-1050/42 bDW NF SC EXC3	> 700 – 800 mA	tc	70 °C	78 °C
		Lifetime	>100,000 h	86,000 h
	> 800 – 905 mA	tc	74 °C	82 °C
		Lifetime	>100,000 h	66,000 h
	> 905 – 1,050 mA	tc	76 °C	83 °C
		Lifetime	>100,000 h	57,000 h

Expected lifetime for independent use

Type	Output current	ta	45 °C	50 °C
	650 mA	tc	79 °C	82 °C
		Lifetime	79,000 h	62,000 h
	> 650 – 700 mA	tc	81 °C	84 °C
		Lifetime	69,000 h	53,000 h
LC 38/650-1050/42 bDW NF SC EXC3	> 700 – 800 mA	tc	83 °C	86 °C
		Lifetime	58,000 h	48,000 h
	> 800 – 905 mA	tc	87 °C	87 °C
		Lifetime	41,000 h	42,000 h
	> 905 – 1,050 mA	tc	87 °C	87 °C
		Lifetime	40,000 h	36,000 h

The LED driver is designed for a lifetime stated above under reference conditions and with a failure probability of less than 10 %.

The relation of tc to ta temperature depends also on the luminaire design.

If the measured tc temperature is approx. 5 K below tc max., ta temperature should be checked and eventually critical components (e.g. ELCAP) measured. Detailed information on request.

According to IEC 60598 – 1 mounting surface temperature is limited to max. 90 °C.

For output power > 32 W, the maximum ambient temperature is limited to 45° C for SR applications.

3. Installation / wiring

3.1 Circuit diagram

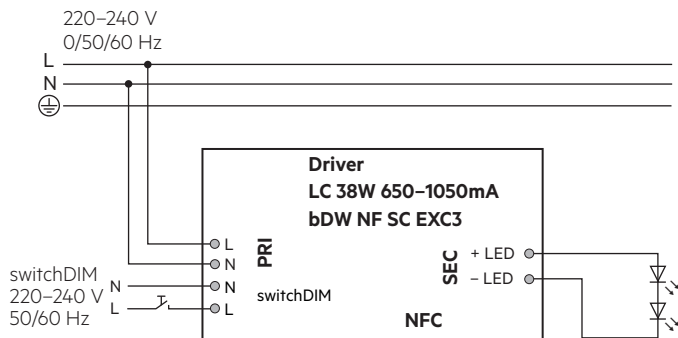

Recommendation to check glowing at standby in combination with class I luminaires.

3.2 Wiring type and cross section

For wiring use stranded wire with ferrules or solid wire from 0.2–1.5 mm². Strip 8.5–9.5 mm of insulation from the cables to ensure perfect operation of the push-wire terminals. Use one wire for each terminal connector only.

LED module/LED driver/supply

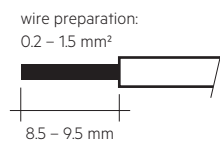

3.3 Loose wiring

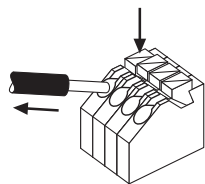

Press down the "push button" and remove the cable from front.

3.4 Fixing conditions when using as independent Driver with Clip-On

Dry, acidfree, oilfree, fatfree. It is not allowed to exceed the maximum ambient temperature (t_a) stated on the device. Minimum distances stated below are recommendations and depend on the actual luminaire. Is not suitable for fixing in corner.

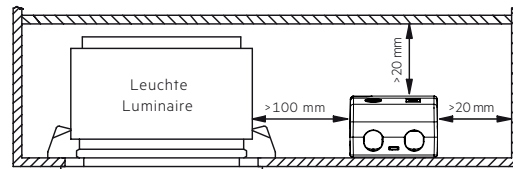

Device not suitable for covering with thermally insulating material according to IEC 60598-1 Ed.9

3.5 Wiring guidelines

- The cables should be run separately from the mains connections and mains cables to ensure good EMC conditions.
- The LED wiring should be kept as short as possible to ensure good EMC. The max. secondary cable length is 2 m (4 m circuit), this applies for LED output.
- To comply with the EMC regulations run the secondary wires (LED module) in parallel.
- Secondary switching is not permitted.
- The LED driver has no inverse-polarity protection on the secondary side. Wrong polarity can damage LED modules with no inverse-polarity protection.
- Wrong wiring of the LED driver can lead to malfunction or irreparable damage.
- To avoid damage of the Driver, the wiring must be protected against short circuits to earth (sharp edged metal parts, metal cable clips, louver, etc.).

3.6 Replace LED module

1. Mains off
2. Remove LED module
3. Wait for 30 seconds
4. Connect LED module again

Hot plug-in or secondary switching of LEDs is not permitted and may cause a very high current to the LEDs.

3.7 Installation note

Max. torque at the clamping screw: 0.5 Nm / M4

4. Electrical values

4.1 Operating window

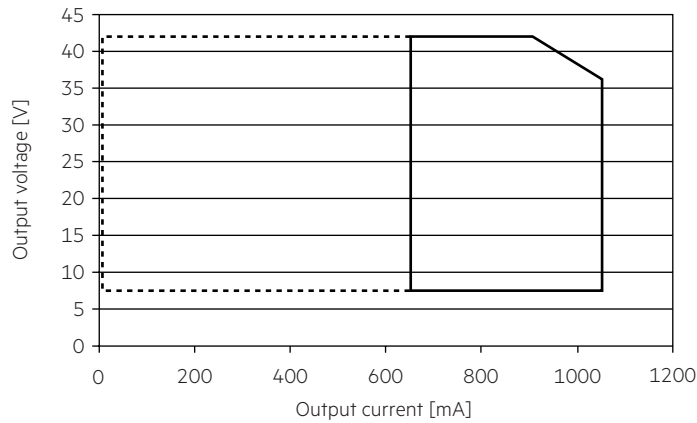

- Operating window 100 %
- - - - - Operating window dimmed

Make sure that the LED driver is operated within the given window under all operating conditions. Special attention needs to be paid at dimming and DC emergency operation as the forward voltage of the connected LED modules varies with the dimming level, due to the implemented amplitude dimming technology. Coming below the specified minimum output voltage of the LED driver may cause the device to shut-down. See chapter “6.10 Light level in DC operation” for more information.

4.2 Efficiency vs load

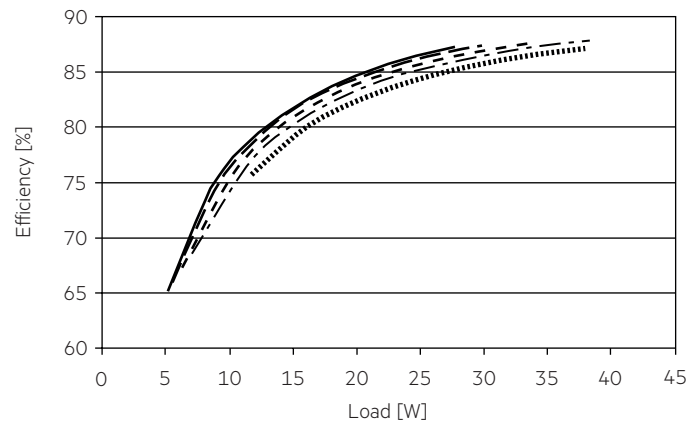

- 650 mA
- - - 700 mA
- . - . 800 mA
- - - - 905 mA
- 1050 mA

4.3 Power factor vs load

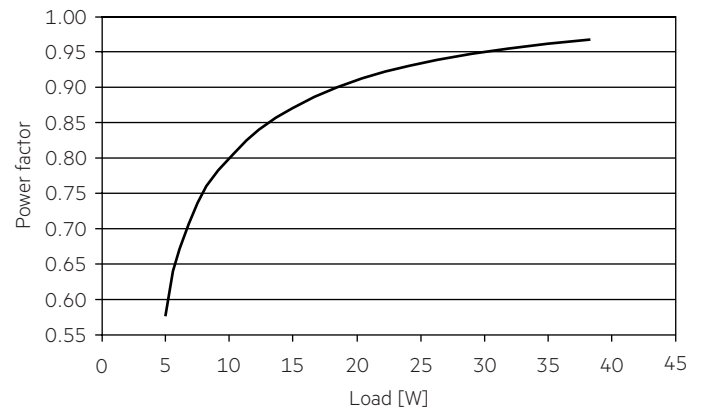

4.4 THD vs load

THD without harmonic < 5 mA (0.6 %) of the input current:

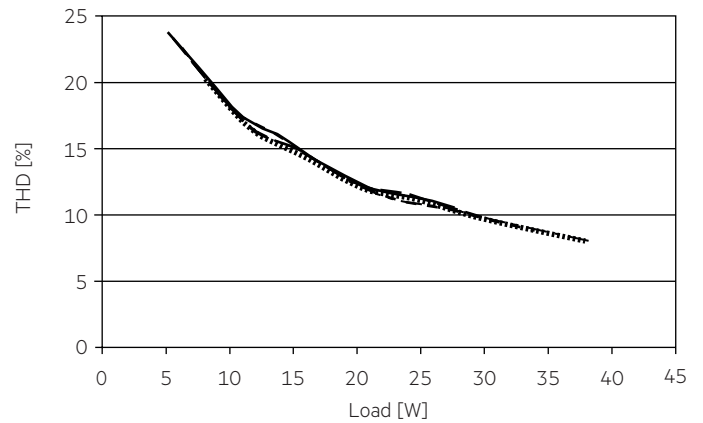

100 % load corresponds to the max. output power (full load) according to the table on page 3.

4.5 Maximum loading of automatic circuit breakers in relation to inrush current

Automatic circuit breaker type	C10	C13	C16	C20	B10	B13	B16	B20	Inrush current	
									I_{max}	time
Installation \emptyset	1.5 mm ²	1.5 mm ²	2.5 mm ²	4 mm ²	1.5 mm ²	1.5 mm ²	2.5 mm ²	4 mm ²		
LC 38/650-1050/42 bDW NF SC EXC3	36	46	56	70	35	46	56	70	5.33 A	42 μ s

These are max. values calculated out of inrush current! Please consider not to exceed the maximum rated continuous current of the circuit breaker.

Calculation uses typical values from ABB series S200 as a reference.

Actual values may differ due to used circuit breaker types and installation environment.

4.6 Harmonic distortion in the mains supply (at 230 V / 50 Hz and full load) in %

	THD					
	3.	5.	7.	9.	11.	
LC 38/650-1050/42 bDW NF SC EXC3	< 9	< 8	< 3	< 4	< 4	< 3

Acc. to 61000-3-2. Harmonics < 5 mA or < 0.6 % (whatever is greater) of the input current are not considered for calculation of THD.

5. Software / Programming / Interfaces

5.1 Software / programming

With appropriate software and interface different functions can be activated and various parameters can be configured in the LED driver. The Driver supports the following software and interfaces:

Software / hardware for configuration:

- companionSUITE (deviceGENERATOR, deviceCONFIGURATOR, deviceANALYSER)

Interfaces for data transfer:

- NFC
- Control input switchDIM

5.2 Nearfield communication (NFC)

The NFC Interface allows wireless communication with the LED driver. This interface offers the option to write configuration and to read configuration, errors and events with the companionSUITE. A correct communication between the LED driver and the NFC antenna can only be guaranteed if the antenna is placed directly on the Driver. Any material placed between the LED driver and the NFC antenna can cause a deterioration of the communication quality. After programming the device via NFC power up the device one time for one second till the deviceANALYSER can read out the parameters. With a strong NFC antenna, several products can be programmed simultaneously ("multi device programming"). We recommend the use of following NFC antenna: www.tridonic.com/nfc-readers

NFC is complied with ISO/IEC 15963 standard.

Changing parameters via NFC shall be done by qualified engineers only.

5.3 Control Input switchDIM

A standard pushbutton can be wired on the terminals (switchDIM). Integrated switchDIM function allows a direct connection of a pushbutton for dimming and switching. Brief push (< 0.6 s) switches LED driver ON and OFF. The dimm level is saved at power-down and restored at power-up. When the pushbutton is held, LED modules are dimmed. After repush the LED modules are dimmed in the opposite direction. In installations with LED drivers with different dimming levels or opposite dimming directions (e.g. after a system extension), all LED drivers can be synchronized to 50 % dimming level by a 10 s push. Use of pushbutton with indicator lamp is not permitted.

















The dimming behaviour is slightly different for mixed systems with DALI and bDW control gears.

6. Functions

☉ companionSUITE:

NFC

The companionSUITE with deviceGENERATOR, deviceCONFIGURATOR and deviceANALYSER is available via our WEB page:
<https://www.tridonic.com/com/en/products/companionsuite.asp>

Icon	Function	NFC
	OEM Identification	☉
	OEM GTIN	☉
	Luminaire data	☉
	Label information	☉
	LED current	☉
	Device operating mode	☉
	Factory reset	☉
	switchDIM fading	☉
	Constant light output (CLO)	☉
	DC level	☉
	Enhanced power on level (ePOL)	☉
	Scenes and groups	☉
	Power-up fading	☉
	deviceKEY	☉
	Energy reports	☉

6.1 OEM Identification



The OEM (Original Equipment Manufacturer) can set his own identification number.

DALI Part 251: Memory bank 1 extension.

6.2 OEM GTIN



The Original Equipment Manufacturer (OEM) can set his own Global Trade Item Number (GTIN).

DALI Part 251: Memory bank 1 extension.

6.3 Luminaire data



This function provides the asset management with accurate data about the luminaire.

DALI Part 251: Memory bank 1 extension.

6.4 Label information



In production, an individual label can be printed out for each device.

For this there are different default values (Batch No., Production Date, ...) available.

In addition, you can use these two text input fields to insert your own luminaire information and print it out.

6.5 LED current



The LED output current must be adapted to the connected LED module. The value is limited by the current range of the respective device.

6.6 Device operating mode



A Tridonic driver supports several control signals.

These control signals are automatically detected and the mode is adapted.

If only one special device mode is required, this mode can be fixed here.

“Automatic detection” is the default setting.

6.7 Factory reset



This device supports the function to reset all parameters back to factory defaults.

6.8 switchDIM fading



Here you can set the fade time of the control gear when using switchDIM.

6.9 Constant Light Output (CLO)



With this function the light output of the LED module can be kept equal over the lifetime.

The light output of an LED module reduces over the course of its lifetime.

The Constant Light Output (CLO) function compensates for this natural decline by constantly increasing the output current of the LED driver throughout its lifetime.

CLO shall be achieved by limitation of the LED current at the commissioning of the LED driver and providing a linear interpolation of the current over the time, depending on the data points given by the user.

6.10 Light level in DC operation



In emergency light systems with a central battery supply the DC recognition function uses the input voltage to detect if emergency mode is present.

The LED driver then automatically switches to DC mode and dims the light to the defined DC level.

Without DC recognition different and more complex solutions would have to be applied in order to detect emergency mode.

DC recognition is integrated in the device as standard.

No additional commissioning is necessary for activation.



This is a safety-relevant parameter.

The setting is relevant for the dimensioning of the central battery system.

The LED driver is designed to operate on DC voltage and pulsed DC voltage. For a reliable operation, make sure that also in DC emergency operation the LED driver is run within the specified conditions as stated in chapter “4.1 operating window”.

Light output level in DC operation: programmable 15 – 100 %
(factory default = 15 %, EOF_i = 0.13).

The voltage-dependent input current of Driver incl. LED module is depending on the used load.

The voltage-dependent no-load current of Driver (without or defect LED module) is for:

AC: < 28.8 mA

DC: < 2.54 mA

6.11 Enhanced power on level (ePOL)



The Enhanced Power On Level parameter defines the power level that is set automatically when power is restored after a power failure.

The Enhanced Power On Level can be set to a fixed value (0 – 100 %) or can recall the memory value.

The memory value is the last value the LED driver was set to before the power failure.

6.12 Scenes and groups



Each device can be a member of up to 16 groups.

Also, 16 different scene values can be stored in each device.

6.13 Power-up fading



The power-up function offers the opportunity to modify the on behavior.

The time for fading on can be adjusted in a range of 0.2 to 16 seconds.

According to this value, the device dims from 0 % up to the power-on level.

By factory default no fading time is set (= 0 seconds).

6.14 deviceKEY



With this function, individual device functions can be protected from unauthorized changes by a password.

6.15 Energy reporting



This function provides the information related to energy reporting accessible through memory banks in this driver.

Several functions and values could be read out to gain access in Content management systems.

Report and values for Active power, Active Energy and many more can be read out.

7. Protective features

7.1 Overtemperature protection

The LED driver is protected against temporary thermal overheating.

If the temperature limit is exceeded the output current of the LED module(s) is reduced. The temperature protection is activated above $t_{c\ max}$.

The activation temperature differs depending on the LED load.

On DC operation this function is deactivated to fulfill emergency requirements.

7.2 Short-circuit behaviour

In case of a short-circuit at the LED output the LED output is switched off. After restart of the LED driver the output will be activated again. The restart can either be done via mains reset or via interface.

7.3 No-load operation

The LED driver will not be damaged in no-load operation. The output will be deactivated and is therefore free of voltage. When connecting an LED load, restart the device to activate the LED output.

7.4 Overload protection

If the maximum load is exceeded by a defined internal limit, the LED driver turns off the LED output. After restart of the LED driver the output will be activated again.

The restart can either be done via mains reset or via interface.

7.5 Insulation between terminals

Insulation	Mains	LED	switchDIM
Mains	–	double	basic
LED	double	–	double
switchDIM	basic	double	–

basic ... represents basic insulation.

double ... represents double or reinforced insulation.

8. Miscellaneous

8.1 Insulation and electric strength testing of luminaires

Electronic devices can be damaged by high voltage. This has to be considered during the routine testing of the luminaires in production.

According to IEC 60598-1 Annex Q (informative only!) or ENEC 303-Annex A, each luminaire should be submitted to an insulation test with 500 V_{DC} for 1 second. This test voltage should be connected between the interconnected phase and neutral terminals and the earth terminal. The insulation resistance must be at least 2 MΩ.

As an alternative, IEC 60598-1 Annex Q describes a test of the electrical strength with 1500 V_{AC} (or 1.414 x 1500 V_{DC}). To avoid damage to the electronic devices this test must not be conducted.

The equipotential terminal is used to connect the heat sink and the LED driver to reduce transients.

8.2 Conditions of storage and use

Humidity: 5% up to max. 85%,
not condensed
(max. 56 days/year at 85%)

Storage temperature: -40 °C up to max. +80 °C

The devices have to be acclimatised to the specified temperature range (ta) before they can be operated.

The LED driver is declared as inbuilt LED controlgear, meaning it is intended to be used within a luminaire enclosure.

If the product is used outside a luminaire, the installation must provide suitable protection for people and environment (e.g. in illuminated ceilings).

8.3 Placement

basicDIM Wireless has an integrated antenna for easy integration. In order to maximize the range in every direction some design guidelines should be taken into consideration when mounting the device.

The antenna is located on the corner of the enclosure. It is on the top side of the internal PCB (Printed Circuit Board).

When the device is mounted on a metal plate (e.g. frame of a luminaire), it may efficiently block the radio frequency signal. In this case, a cut-out underneath the antenna may be needed for the RF signal to exit the structure. The cut-out area should be as large as possible. Also the device should be placed as far away from any vertical metal structures as possible.

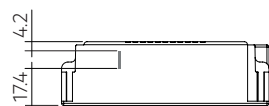

■ Antenna location

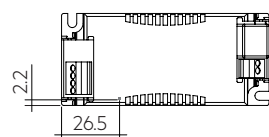

The range of the communication signal is depending on the environment e.g. luminaire, construction of the building, furnitures or humans and needs to be tested and approved in the installation.

The range of the LED drivers is up to 15 m (from unit to unit and from unit to App).

If the LED drivers are installed in a extremely well-shielded luminaire (metal body, spotlight, ...), then the range is up to 5 m.

This information is given as a guide. Luminaire construction, installation situation and construction conditions have a direct influence on the communication range and must be tested by the customer.

8.4 Network compatibility

This Driver is fully compatible with networks which support up to 250 nodes (Evolution networks). If the Driver is used with different types of basicDIM Wireless devices in an Evolution network, their compatibility has to be checked before. If a device is not compatible with Evolution networks, it can be only used in networks which support up to max. of 127 devices (Classic networks).

8.5 Maximum number of switching cycles

All LED driver are tested with 50,000 switching cycles.

The actually achieved number of switching cycles is significantly higher.

8.6 Additional information

Additional technical information at www.tridonic.com → Technical Data

Lifetime declarations are informative and represent no warranty claim. No warranty if device was opened.