

**Driver LC 38W 350–1050mA bDW TW SR PRE2**  
LED driver premium Tunable White



**Product description**

- \_ Can be integrated in Casambi systems (Casambi Ready)
- \_ NEW: lumDATA (DALI-2 part ext. 251, 252 and 253)
- \_ Independent dimmable constant current 2-channel LED driver with strain-relief
- \_ Forms automatically a wireless communication network with up to 250 nodes
- \_ Adjustable output current between 350 and 1,050 mA via I-SELECT 2 plugs
- \_ Max. output power 38 W
- \_ Up to 87 % efficiency
- \_ Power input on stand-by < 0.37 W
- \_ Dimming range 1 to 100 %
- \_ Suitable for luminaires of protection class I and protection class II (see data sheet chapter 3.4 for details)
- \_ Nominal lifetime up to 100,000 h
- \_ 5 years guarantee (conditions at <https://www.tridonic.com/en/int/services/manufacturer-guarantee-conditions>)
- \_ We will provide security updates for the next five years after the date of purchase of this product

**Housing properties**

- \_ Casing: polycarbonate, black
- \_ Type of protection IP20
- \_ Strain relief with loop through function

**Interfaces**

- \_ basicDIM Wireless
- \_ Terminal blocks: 45° / 0° push terminals

**Functions**

- \_ Adjustable output current in 1-mA-steps (I-SELECT 2)
- \_ Constant light output function (CLO)
- \_ Power-up fading and fade2zero
- \_ Protective features (overtemperature, short-circuit, overload, no-load, reduced surge amplification)
- \_ Intelligent Voltage Guard (overvoltage and undervoltage monitoring)
- \_ Suitable for emergency escape lighting systems acc. to EN 50172

**Benefits**

- \_ Application-oriented operating window for maximum compatibility
- \_ Best energy savings due to low stand-by losses

**Typical applications**

- \_ For spot light and downlight in retail and hospitality applications
- \_ Tunable white application

**Website**

<http://www.tridonic.com/28002584>



Linear



High bay



Decorative



Downlights



Spotlights



Free-standing



Area



Floor | Wall



Street

**Driver LC 38W 350–1050mA bDW TW SR PRE2**  
LED driver premium Tunable White

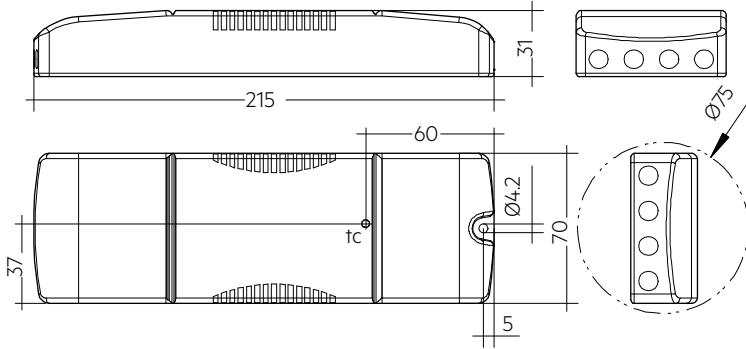

**Ordering data**

Type	Article number	Packaging, carton	Packaging, pallet	Weight per pc.
LC 38/350-1050/50 bDW TW SR PRE2	28002584	10 pc(s).	400 pc(s).	0.235 kg

### Technical data

Rated supply voltage	220 – 240 V
AC voltage range	198 – 264 V
DC voltage range	176 – 288 V
Mains frequency	0 / 50 / 60 Hz
Overvoltage protection	320 V AC, 48 h
Typ. current (at 230 V, 50 Hz, full load) <sup>①②</sup>	96 – 192 mA
Typ. current (220 V, 0 Hz, full load, 15 % dimming level) <sup>②</sup>	35 mA
Leakage current (at 230 V, 50 Hz, full load) <sup>①②</sup>	< 500 µA
Typ. efficiency (at 230 V, 50 Hz, full load) <sup>②</sup>	87 %
λ (at 230 V, 50 Hz, full load) <sup>①</sup>	> 0.96C
Typ. power consumption on stand-by	< 0.37 W
Typ. input current in no-load operation	22 mA
Typ. input power in no-load operation	< 0.5 W
In-rush current (peak / duration)	26.4 A / 224 µs
THD (at 230 V, 50 Hz, full load) <sup>①</sup>	< 10 %
Starting time (at 230 V, 50 Hz, full load) <sup>①</sup>	< 0.6 s
Starting time (DC mode)	< 0.4 s
Switchover time (AC/DC) <sup>③</sup>	< 0.2 s
Turn off time (at 230 V, 50 Hz, full load)	< 20 ms
Output current tolerance <sup>①④</sup>	± 3 %
Max. output current peak (non-repetitive)	≤ output current + 20 %
Output LF current ripple (< 120 Hz)	± 2 %
Output P_ST_LM (at full load)	≤ 1
Output SVM (at full load)	≤ 0.4
Max. output voltage (U-OUT)	60 V
Dimming range	1 – 100 %
Colour tuning range	2,700 – 6,500 K
Mains surge capability (between L - N)	1 kV
Mains surge capability (between L/N - PE)	2 kV
Surge voltage at output side (against PE)	< 500 V
Type of protection	IP20
Radio transceiver operating frequencies	2.4 – 2.483 GHz
Max. output power radio transceiver (E.I. R.P.) <sup>⑤</sup>	< + 20 dBm
Radio protocol	Bluetooth 4.0 or 5.0 Low Energy (BLE)
Capable for mesh network	Up to 250 nodes / Standard networks and Long Range
Lifetime	up to 100,000 h
Guarantee (conditions at <a href="http://www.tridonic.com">www.tridonic.com</a> )	5 Year(s)
Dimensions L x W x H	215 x 70 x 31 mm

### Approval marks



### Standards

EN 55015, EN 61000-3-2, EN 61000-3-3, EN 61347-1, EN 61347-2-13, EN 62384, EN 61547, ETSI EN 300 330, ETSI EN 301 489-1, ETSI EN 301 489-3, ETSI EN 300 328, ETSI EN 301 489-17, according to EN 50172, according to EN 60598-2-22

### Specific technical data

Type	Output <sup>④</sup> current	Min. output voltage	Max. output voltage	Max. output power	Typ. power consumption (at 230 V, 50 Hz, full load)	Typ. current consumption (at 230 V, 50 Hz, full load)	t <sub>c</sub> point max.	Ambient temperature t <sub>a</sub>	I-SELECT 2 resistor value <sup>⑥</sup>
LC 38/350-1050/50 bDW TW SR PRE2	350 mA	20 V	50.0 V	17.5 W	21.1 W	96 mA	75 °C	-25 ... +60 °C	-
LC 38/350-1050/50 bDW TW SR PRE2	400 mA	20 V	50.0 V	20.0 W	23.7 W	107 mA	75 °C	-25 ... +55 °C	12.50 kΩ
LC 38/350-1050/50 bDW TW SR PRE2	450 mA	20 V	50.0 V	22.5 W	26.4 W	119 mA	75 °C	-25 ... +55 °C	11.11 kΩ
LC 38/350-1050/50 bDW TW SR PRE2	500 mA	20 V	50.0 V	25.0 W	29.1 W	130 mA	75 °C	-25 ... +55 °C	10.00 kΩ
LC 38/350-1050/50 bDW TW SR PRE2	550 mA	20 V	50.0 V	27.5 W	31.7 W	141 mA	75 °C	-25 ... +55 °C	9.09 kΩ
LC 38/350-1050/50 bDW TW SR PRE2	600 mA	20 V	50.0 V	30.0 W	34.4 W	152 mA	75 °C	-25 ... +55 °C	8.33 kΩ
LC 38/350-1050/50 bDW TW SR PRE2	650 mA	20 V	50.0 V	32.5 W	37.0 W	164 mA	75 °C	-25 ... +55 °C	7.69 kΩ
LC 38/350-1050/50 bDW TW SR PRE2	700 mA	20 V	50.0 V	35.0 W	39.9 W	176 mA	75 °C	-25 ... +55 °C	7.14 kΩ
LC 38/350-1050/50 bDW TW SR PRE2	750 mA	20 V	50.0 V	37.5 W	42.5 W	187 mA	75 °C	-25 ... +50 °C	6.67 kΩ
LC 38/350-1050/50 bDW TW SR PRE2	800 mA	20 V	47.5 V	38.0 W	42.9 W	189 mA	75 °C	-25 ... +50 °C	6.25 kΩ
LC 38/350-1050/50 bDW TW SR PRE2	850 mA	20 V	44.7 V	38.0 W	43.1 W	190 mA	75 °C	-25 ... +50 °C	5.88 kΩ
LC 38/350-1050/50 bDW TW SR PRE2	900 mA	20 V	42.2 V	38.0 W	43.3 W	191 mA	75 °C	-25 ... +50 °C	5.56 kΩ
LC 38/350-1050/50 bDW TW SR PRE2	950 mA	20 V	40.0 V	38.0 W	43.4 W	191 mA	75 °C	-25 ... +50 °C	5.26 kΩ
LC 38/350-1050/50 bDW TW SR PRE2	1,000 mA	20 V	38.0 V	38.0 W	43.4 W	191 mA	75 °C	-25 ... +50 °C	5.00 kΩ
LC 38/350-1050/50 bDW TW SR PRE2	1,050 mA	20 V	36.2 V	38.0 W	43.6 W	192 mA	75 °C	-25 ... +50 °C	0.00 kΩ

① Valid at 100 % dimming level.

② Depending on the selected output current.

③ Valid for immediate change of power supply type otherwise the starting time is valid.

④ Output current is mean value.

- ⑤ E.I.R.P.: Equivalent Isotropically Radiated Power.
- ⑥ The table only lists a number of possible operating points but does not cover each single point. The output current can be set within the total value range in 1-mA-steps.
- ⑦ Not compatible with I-SELECT (generation 1). Calculated resistor value.

I-SELECT 2 PLUG PRE / EXC

Accessory

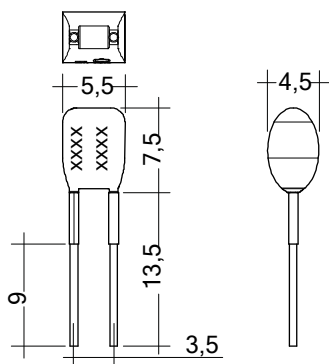

Product description

- \_ Ready-for-use resistor to set output current value
- \_ Compatible with LED driver featuring I-select 2 interface; not compatible with I-SELECT (generation 1)
- \_ Resistor is base insulated
- \_ Resistor power 0.25 W
- \_ Current tolerance  $\pm 2\%$  additional to output current tolerance
- \_ Compatible with LED driver series PRE and EXC

Example of calculation

- \_  $R [k\Omega] = 5 V / I_{out} [mA] \times 1000$
- \_ E96 resistor value used
- \_ Resistor value tolerance  $\leq 1\%$ ; resistor power  $\geq 0.1 W$ ; base insulation necessary
- \_ When using a resistor value beyond the specified range, the output current will automatically be set to the minimum value (resistor value too big), respectively to the maximum value (resistor value too small)

Website

<http://www.tridonic.com/28001110>



Ordering data

Type	Article number	Colour	Marking	Current	Resistor value	Packaging, bag	Weight per pc.
I-SELECT 2 PLUG 350MA BL	28001110	Blue	0350 mA	350 mA	14.30 k $\Omega$	10 pc(s).	0.001 kg
I-SELECT 2 PLUG 375MA BL	28001111	Blue	0375 mA	375 mA	13.30 k $\Omega$	10 pc(s).	0.001 kg
I-SELECT 2 PLUG 400MA BL	28001112	Blue	0400 mA	400 mA	12.40 k $\Omega$	10 pc(s).	0.001 kg
I-SELECT 2 PLUG 425MA BL	28001251	Blue	0425 mA	425 mA	11.80 k $\Omega$	10 pc(s).	0.001 kg
I-SELECT 2 PLUG 450MA BL	28001113	Blue	0450 mA	450 mA	11.00 k $\Omega$	10 pc(s).	0.001 kg
I-SELECT 2 PLUG 475MA BL	28001252	Blue	0475 mA	475 mA	10.50 k $\Omega$	10 pc(s).	0.001 kg
I-SELECT 2 PLUG 500MA BL	28001114	Blue	0500 mA	500 mA	10.00 k $\Omega$	10 pc(s).	0.001 kg
I-SELECT 2 PLUG 525MA BL	28001960	Blue	0525 mA	525 mA	9.53 k $\Omega$	10 pc(s).	0.001 kg
I-SELECT 2 PLUG 550MA BL	28001115	Blue	0550 mA	550 mA	9.09 k $\Omega$	10 pc(s).	0.001 kg
I-SELECT 2 PLUG 600MA BL	28001116	Blue	0600 mA	600 mA	8.25 k $\Omega$	10 pc(s).	0.001 kg
I-SELECT 2 PLUG 650MA BL	28001117	Blue	0650 mA	650 mA	7.68 k $\Omega$	10 pc(s).	0.001 kg
I-SELECT 2 PLUG 700MA BL	28001118	Blue	0700 mA	700 mA	7.15 k $\Omega$	10 pc(s).	0.001 kg
I-SELECT 2 PLUG 750MA BL	28001119	Blue	0750 mA	750 mA	6.65 k $\Omega$	10 pc(s).	0.001 kg
I-SELECT 2 PLUG 800MA BL	28001120	Blue	0800 mA	800 mA	6.19 k $\Omega$	10 pc(s).	0.001 kg
I-SELECT 2 PLUG 850MA BL	28001121	Blue	0850 mA	850 mA	5.90 k $\Omega$	10 pc(s).	0.001 kg
I-SELECT 2 PLUG 900MA BL	28001122	Blue	0900 mA	900 mA	5.62 k $\Omega$	10 pc(s).	0.001 kg
I-SELECT 2 PLUG 950MA BL	28001123	Blue	0950 mA	950 mA	5.23 k $\Omega$	10 pc(s).	0.001 kg
I-SELECT 2 PLUG 1000MA BL	28001124	Blue	1000 mA	1,000 mA	4.99 k $\Omega$	10 pc(s).	0.001 kg
I-SELECT 2 PLUG 1050MA BL	28001125	Blue	1050 mA	1,050 mA	4.75 k $\Omega$	10 pc(s).	0.001 kg
I-SELECT 2 PLUG MAX BL	28001099	Blue	MAX	MAX	0.00 k $\Omega$	10 pc(s).	0.001 kg

1. Standards

- EN 55015
- EN 61000-3-2
- EN 61000-3-3
- EN 61347-1
- EN 61347-2-13
- EN 62384
- EN 61547
- ETSI EN 300 330
- ETSI EN 301 489-1
- ETSI EN 301 489-3
- ETSI EN 300 328
- ETSI EN 301 489-17

According to EN 50172 for use in central battery systems

According to EN 60598-2-22 suitable for emergency lighting installations

2. Thermal details and lifetime

2.1 Expected lifetime

Expected lifetime									
Type	Output current	ta	30 °C	35 °C	40 °C	45 °C	50 °C	55 °C	60 °C
LC 38/350-1050/50 bDW TW SR PRE2	350 mA	tc	50 °C	53 °C	58 °C	60 °C	65 °C	70 °C	75 °C
		Lifetime	> 100,000 h	> 100,000 h	> 100,000 h	> 100,000 h	> 100,000 h	90,000 h	65,000 h
	350 – 700 mA	tc	55 °C	58 °C	60 °C	65 °C	70 °C	75 °C	–
		Lifetime	> 100,000 h	> 100,000 h	> 100,000 h	> 100,000 h	80,000 h	55,000 h	–
	700 – 1,050 mA	tc	60 °C	63 °C	65 °C	70 °C	75 °C	–	–
		Lifetime	> 100,000 h	> 100,000 h	> 100,000 h	80,000 h	55,000 h	–	–

The LED driver is designed for a lifetime stated above under reference conditions and with a failure probability of less than 10 %.

The relation of tc to ta temperature depends also on the luminaire design.

If the measured tc temperature is approx. 5 K below tc max., ta temperature should be checked and eventually critical components (e.g. ELCAP) measured. Detailed information on request.

3. Installation / wiring

3.1 Circuit diagram

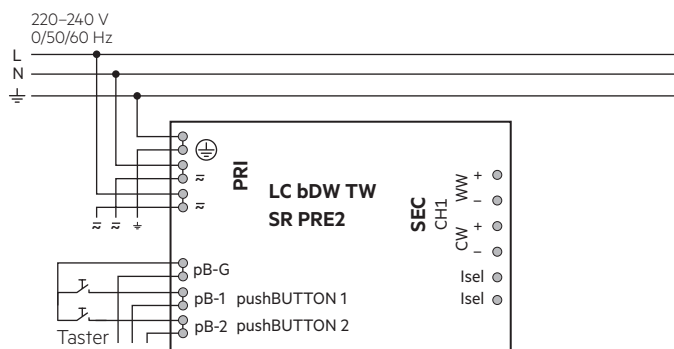

**!** Recommendation to check glowing at standby in combination with class I luminaires.

The used push button has to be insulated.  
 Device with loop through wiring function.  
 Connecting 230 V on the pushBUTTON terminal will damage the driver.

3.2 Wiring type and cross section

Mains supply wires

For wiring use stranded wire or solid wire from 0.5 to 2.5 mm<sup>2</sup>.  
 Strip 10–11 mm of insulation from the cables to ensure perfect operation of the push terminals.  
 Use one wire for each terminal connector only.  
 Use each strain relief channel for one cable only.

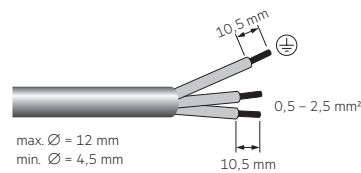

Secondary wires (LED module)

For wiring use stranded wire with ferrules or solid wire from 0.2–1.5 mm<sup>2</sup>.  
 Strip 8.5–9.5 mm of insulation from the cables to ensure perfect operation of the push-wire terminals.  
 Use one wire for each terminal connector only.  
 Use each strain relief channel for one cable only.

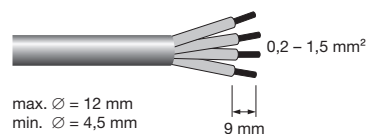

### 3.3 Loose wiring

Press down the "push button" and remove the cable from front.

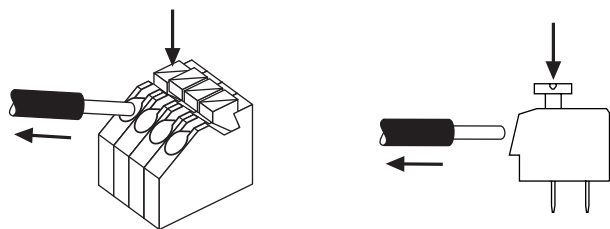

### 3.4 Fixing conditions when using as independent Driver with Clip-On

Dry, acidfree, oilfree, fatfree. It is not allowed to exceed the maximum ambient temperature ( $t_a$ ) stated on the device. Minimum distances stated below are recommendations and depend on the actual luminaire. Device is not suitable for fixing in corner.

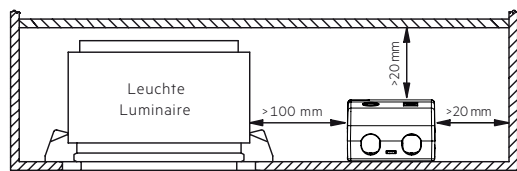

Device not suitable for covering with thermally insulating material according to IEC 60598-1 Ed.9

### 3.5 Wiring guidelines

- Run the secondary lines separately from the mains connections and lines to achieve good EMC performance.
- The max. secondary cable (LED module) length is 2 m (4 m circuit).
- For good EMC performance, keep the LED wiring as short as possible.
- To comply with the EMC regulations run the secondary wires (LED module) in parallel.
- Secondary switching is not permitted.
- The LED driver has no inverse-polarity protection on the secondary side. Wrong polarity can damage LED modules with no inverse-polarity protection.
- Wrong wiring of the LED driver can lead to malfunction or irreparable damage.
- Through wiring of mains is for connecting additional LED driver only. Max. permanent current of 14 A may not be exceeded.
- To avoid damage of the Driver, the wiring must be protected against short circuits to earth (sharp edged metal parts, metal cable clips, louver, etc.).

### 3.6 Hot plug-in

Hot plug-in is not supported due to residual output voltage of  $> 0$  V. When connecting an LED load, restart the device to activate the LED output. This can be done via mains reset or interface (basicDIM Wireless).

### 3.7 Earth connection

The earth connection is conducted as protection earth (PE). The LED driver can be earthed via earth terminal. If the LED driver will be earthed, protection earth (PE) has to be used. There is no earth connection required for the functionality of the LED driver.

Earth connection is recommended to improve following behaviour:

- Electromagnetic interferences (EMI)
- LED glowing at stand-by
- Transmission of mains transients to the LED output

In general it is recommended to earth the LED driver if the LED module is mounted on earthed luminaire parts respectively heat sinks and thereby representing a high capacity against earth.

### 3.8 I-SELECT 2 resistors connected via cable

For details see:

[http://www.tridonic.com/com/en/download/technical/LCA\\_PRE\\_LC\\_EXC\\_ProductManual\\_en.pdf](http://www.tridonic.com/com/en/download/technical/LCA_PRE_LC_EXC_ProductManual_en.pdf).

### 3.9 Installation note

Max. torque at the clamping screw: 0.5 Nm / M4

4. Electrical values

4.1 Operating window

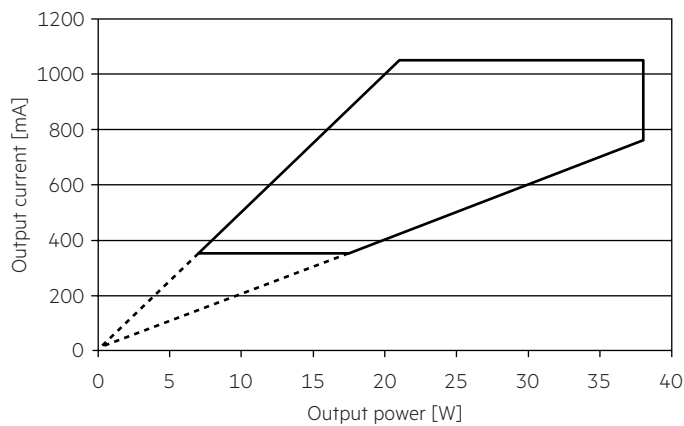
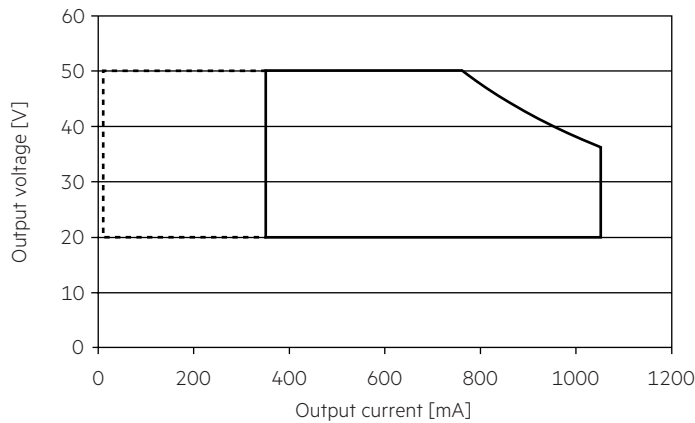

— Operating window 100 %  
 - - - - - Operating window dimmed

Make sure that the LED driver is operated within the given window under all operating conditions. Special attention needs to be paid at dimming and DC emergency operation as the forward voltage of the connected LED modules varies with the dimming level, due to the implemented amplitude dimming technology. Coming below the specified minimum output voltage of the LED driver may cause the device to shut-down. See chapter "6.8 Light level in DC operation" for more information.

4.2 Efficiency vs load

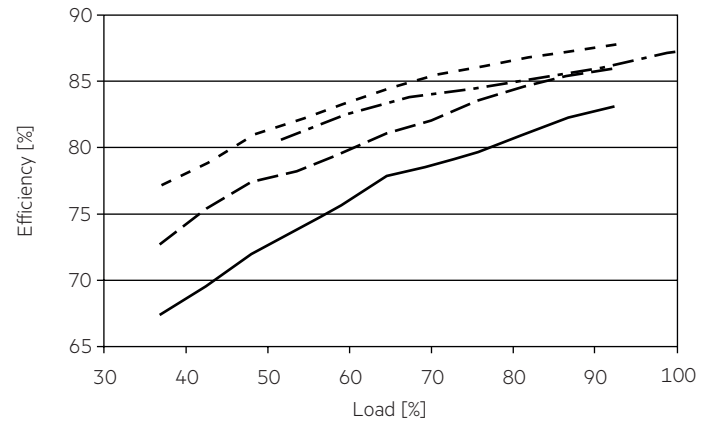

4.3 Power factor vs load

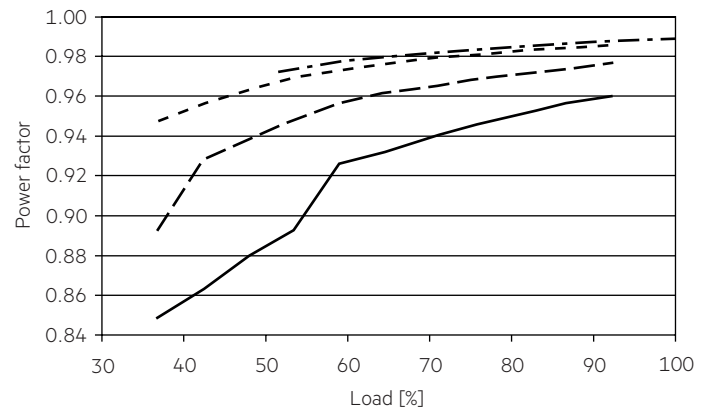

4.4 THD vs load

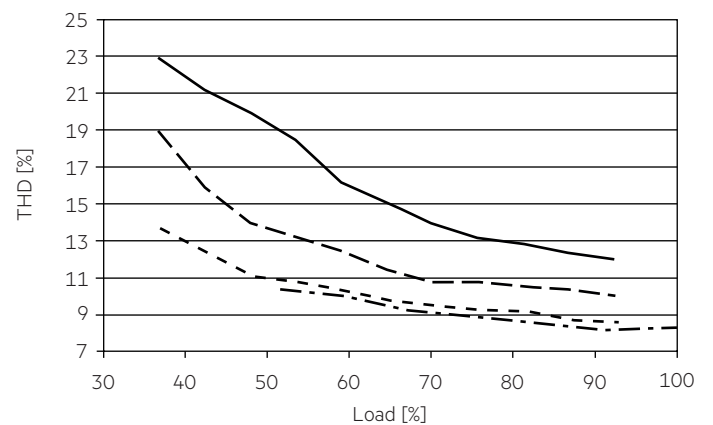

— 350 mA  
 - - - - - 500 mA  
 - - - - - 700 mA  
 - · - · - 1050 mA

100 % load corresponds to the max. output power (full load) according to the table on page 2.

**4.5 Maximum loading of automatic circuit breakers in relation to inrush current**

Automatic circuit breaker type	C10	C13	C16	C20	B10	B13	B16	B20	Inrush current	
Installation Ø	1.5 mm <sup>2</sup>	1.5 mm <sup>2</sup>	2.5 mm <sup>2</sup>	4 mm <sup>2</sup>	1.5 mm <sup>2</sup>	1.5 mm <sup>2</sup>	2.5 mm <sup>2</sup>	4 mm <sup>2</sup>	I <sub>max</sub>	time
<b>LC 38/350-1050/50 bDW TW SR PRE2</b>	16	21	26	33	10	13	16	20	26 A	224 µs

These are max. values calculated out of inrush current! Please consider not to exceed the maximum rated continuous current of the circuit breaker. Calculation uses typical values from ABB series S200 as a reference. Actual values may differ due to used circuit breaker types and installation environment.

**4.6 Harmonic distortion in the mains supply (at 230 V / 50 Hz and full load) in %**

	THD	3.	5.	7.	9.	11.
<b>LC 38/350-1050/50 bDW TW SR PRE2</b>	< 10	< 10	< 3	< 3	< 2	< 2

**4.7 Dimming**

Dimming range 1% to 100 %  
 Digital control with:  
 • basicDIM Wireless

**4.8 Dimming characteristics**

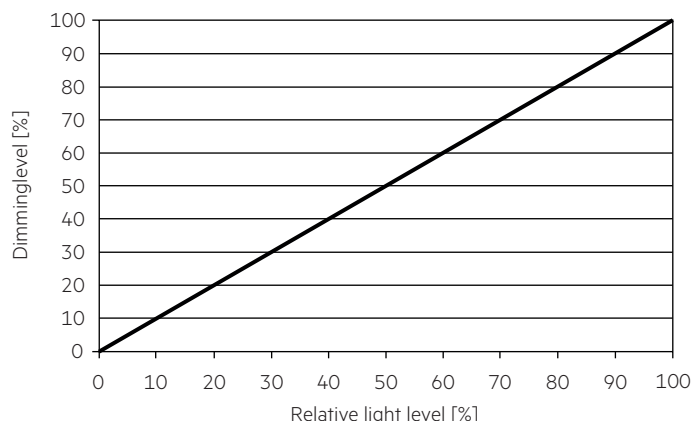

**5. Interfaces / communication**

**5.1 Control input**

A standard push button can be connected on the input terminals. Maximum cable length of the push button is 1 meter. This function have to be activated before using.

The control signal is not SELV. Control cable has to be installed in accordance to the requirements of low voltage installations. Different functions depending on each module. Profile change see handbook [https://www.tridonic.com/com/en/download/technical/Documentation\\_Tridonic\\_4remote\\_BT\\_EN.pdf](https://www.tridonic.com/com/en/download/technical/Documentation_Tridonic_4remote_BT_EN.pdf)

**6. Functions**

**6.1 Function: adjustable current**

The output current of the LED driver can be adjusted in a certain range. For adjustment there is one option available.

Option 1: I-SELECT 2

By inserting a suitable resistor into the I-SELECT 2 interface, the current value can be adjusted. The relationship between output current and resistor value can be found in the chapter "Accessories I-SELECT 2 Plugs".



Please note that the resistor values for I-SELECT 2 are not compatible with I-SELECT (generation 1). Installation of an incorrect resistor may cause irreparable damage to the LED module(s).

Resistors for the main output current values can be ordered from Tridonic (see accessories).

**6.2 Short-circuit behaviour**

In case of a short-circuit at the LED output the LED output is switched off. After restart of the LED driver the output will be activated again. The restart can either be done via mains reset or via software or push button.

**6.3 No-load operation**

The LED driver will not be damaged in no-load operation. The output will be deactivated and is therefore free of voltage. If a LED load is connected the device has to be restarted before the output will be activated again.

**6.4 Overload protection**

If the maximum load is exceeded by a defined internal limit, the LED driver turns off the LED output. After restart of the LED driver the output will be activated again. The restart can either be done via mains reset or via software or push button.

### 6.5 Overtemperature protection

The LED driver is protected against temporary thermal overheating. If the temperature limit is exceeded the output current of the LED module(s) is reduced. The temperature protection is activated above  $t_{c\ max}$ . The activation temperature differs depending on the LED load. On DC operation this function is deactivated to fulfill emergency requirements.

### 6.6 Constant light output (CLO)

The luminous flux of a LED decreases constantly over the lifetime. The CLO function ensures that the emitted luminous flux remains stable. For that purpose the LED current will increase continuously over the LED lifetime. The LED driver adjusts the current afterwards automatically.

### 6.7 Power-up/-down fading

The power-up/-down function offers the opportunity to modify the on-/off behavior. The time for fading on or off can be adjusted in a range of 0.2 to 16 seconds. According to this value, the device dims either from 0 % up to the power-on level or from the current set dim level down to 0 %. This feature applies while operating via 4remoteBT and when switching the mains voltage on or off. By factory default no fading time is set (=0s).

### 6.8 Light level in DC operation

The LED driver is designed to operate on DC voltage and pulsed DC voltage. For a reliable operation, make sure that also in DC emergency operation the LED driver is run within the specified conditions as stated in chapter "4.1 operating window".

Light output level in DC operation: programmable 1 – 100 % (EOFi = 0.13).  
Programming by utilityAPP.

The voltage-dependent input current of Driver incl. LED module is depending on the used load.

The voltage-dependent no-load current of Driver (without or defect LED module) is for:

AC: 22 mA (at 230 V, 50 Hz)  
DC: 6 – 10 mA (at 275 – 186 V, 0 Hz)

### 6.9 Intelligent Voltage Guard

Intelligent Voltage Guard is the name of the electronic monitoring of the mains voltage. It immediately shows if the mains voltage rises above certain thresholds. Measures can then be taken quickly to prevent damage to the LED driver.

- If the mains voltage rises above approx. 280 Vrms (voltage depends on the LED driver type), the LED light starts flashing on and off.
- To avoid a damage of the LED driver the mains supply has to be switched off at this signal.

### 6.10 Software / programming

With appropriate software and an interface different functions can be activated and various parameters can be configured in the LED driver. To do so, the utilityAPP is required.

## 7. Miscellaneous

### 7.1 Insulation and electric strength testing of luminaires

Electronic devices can be damaged by high voltage. This has to be considered during the routine testing of the luminaires in production.

According to IEC 60598-1 Annex Q (informative only!) or ENEC 303-Annex A, each luminaire should be submitted to an insulation test with 500 V<sub>DC</sub> for 1 second. This test voltage should be connected between the interconnected phase and neutral terminals and the earth terminal. The insulation resistance must be at least 2 MΩ.

As an alternative, IEC 60598-1 Annex Q describes a test of the electrical strength with 1500 V<sub>AC</sub> (or 1.414 x 1500 V<sub>DC</sub>). To avoid damage to the electronic devices this test must not be conducted.

### 7.2 Conditions of use and storage

Humidity: 5 % up to max. 85 %,  
not condensed  
(max. 56 days/year at 85 %)

Storage temperature: -40 °C up to max. +80 °C

The devices have to be acclimatised to the specified temperature range (ta) before they can be operated.

The LED driver is declared as inbuilt LED controlgear, meaning it is intended to be used within a luminaire enclosure.

If the product is used outside a luminaire, the installation must provide suitable protection for people and environment (e.g. in illuminated ceilings).

### 7.3 Placement

basicDIM Wireless has an integrated antenna for easy integration. In order to maximize the range in every direction some design guidelines should be taken into consideration when mounting the device.

The antenna is located on the corner of the enclosure. It is on the top side of the internal PCB (Printed Circuit Board).

When the device is mounted on a metal plate (e.g. frame of a luminaire), it may efficiently block the radio frequency signal. In this case, a cut-out underneath the antenna may be needed for the RF signal to exit the structure. The cut-out area should be as large as possible. Also the device should be placed as far away from any vertical metal structures as possible.

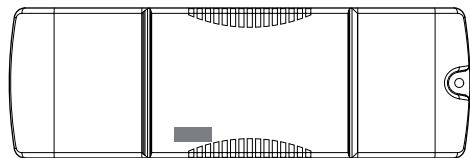

■ Antenna location



The range of the communication signal is depending on the environment e.g. luminaire, construction of the building, furnitures or humans and needs to be tested and approved in the installation.

### 7.4 Network compatibility

This Driver is fully compatible with networks which support up to 250 nodes (Evolution networks). If the Driver is used with different types of basicDIM Wireless devices in an Evolution network, their compatibility has to be checked before. If a device is not compatible with Evolution networks, it can be only used in networks which support up to max. of 127 devices (Classic networks).

### 7.5 Maximum number of switching cycles

All LED driver are tested with 50,000 switching cycles. The actually achieved number of switching cycles is significantly higher.

### 7.6 Additional information

Additional technical information at [www.tridonic.com](http://www.tridonic.com) → Technical Data

Lifetime declarations are informative and represent no warranty claim. No warranty if device was opened.