

Driver LC 35W 250/300/350mA fixC Ip SNC2

essence series

**Product description**

- _ Fixed output built-in LED driver
- _ Constant current LED driver
- _ For luminaires of protection class I and protection class II
- _ Temperature protection as per EN 61347-2-13 C5e
- _ Output current 250, 300 or 350 mA
- _ Max. output power 35 W
- _ Up to 90 % efficiency
- _ Nominal lifetime up to 50,000 h
- _ 5 years guarantee (conditions at

<https://www.tridonic.com/en/int/services/manufacturer-guarantee-conditions>)

Housing properties

- _ Casing: metal, white
- _ Type of protection IP20

Functions

- _ Overload protection
- _ Short-circuit protection
- _ No-load protection
- _ Burst protection voltage 0.5 kV
- _ Surge protection voltage 1 kV (L to N)
- _ Surge protection voltage 2 kV (L/N to earth)

Website

<http://www.tridonic.com/87500838>

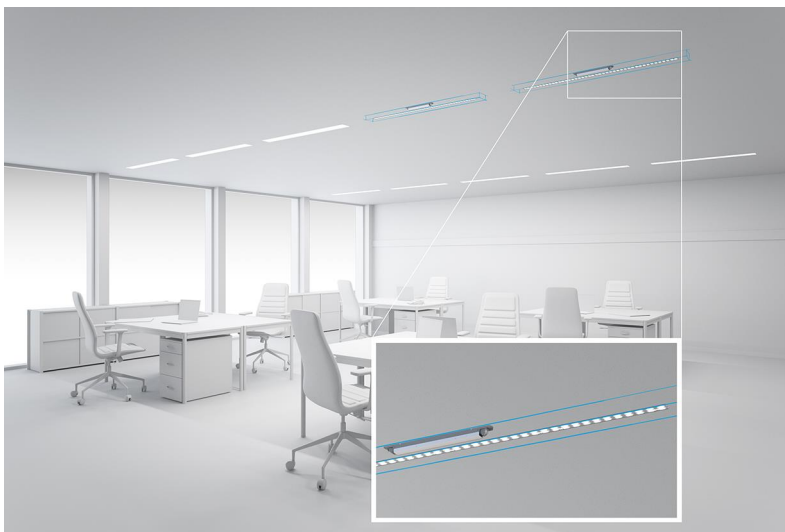

Linear



High bay



Decorative



Downlights



Spotlights



Free-standing



Area



Floor | Wall



Street

Driver LC 35W 250/300/350mA fixC Ip SNC2

essence series

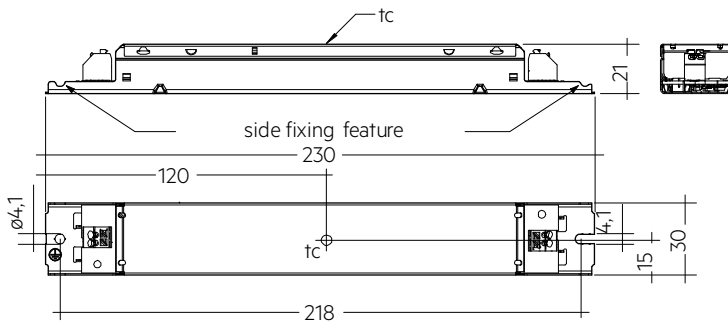

Ordering data

Type	Article number	Packaging, carton	Packaging, low volume	Packaging, high volume	Weight per pc.
LC 35/250/140 fixC Ip SNC2	87500838	50 pc(s).	1,050 pc(s).	3,150 pc(s).	0.128 kg
LC 35/300/121 fixC Ip SNC2	87500839	50 pc(s).	1,050 pc(s).	3,150 pc(s).	0.128 kg
LC 35/350/104 fixC Ip SNC2	87500840	50 pc(s).	1,050 pc(s).	3,150 pc(s).	0.128 kg

Technical data

Rated supply voltage	220 – 240 V
AC voltage range	198 – 264 V
Mains frequency	50 / 60 Hz
Leakage current (at 230 V, 50 Hz, full load)	< 450 µA
λ over full operating range (min.) ^①	0.9C
Max. output voltage (U-OUT)	320 V
THD (at 230 V, 50 Hz, full load)	< 20 %
Output current tolerance ^②	± 7.5 %
Typ. current ripple (at 230 V, 50 Hz, full load)	± 5 %
Output P _{ST_LM} (at full load)	≤ 1
Output SVM (at full load)	≤ 0.4
Starting time (at 230 V, 50 Hz, full load)	≤ 0.5 s
Turn off time (at 230 V, 50 Hz, full load)	≤ 0.5 s
Hold on time at power failure (output)	0 s
Ambient temperature t_a	-20 ... +50 °C
Ambient temperature t_a (at lifetime 50,000 h)	50 °C
Storage temperature t_s	-40 ... +80 °C
Mains burst capability	0.5 kV
Mains surge capability (between L - N)	1 kV
Mains surge capability (between L/N - PE)	2 kV
Surge voltage at output side (against PE)	4 kV
Type of protection	IP20
Lifetime	up to 50,000 h
Guarantee (conditions at www.tridonic.com)	5 Year(s)
Dimensions L x W x H	230 x 30 x 21 mm
Hole spacing D	218 mm

Approval marks



Standards

EN 55015, EN 61000-3-2, EN 61000-3-3, EN 61347-2-13, EN 61547, EN 62384

Specific technical data

Type	Output current ^②	Input current (at 230 V, 50 Hz, full load)	Max. input power	Typ. power consumption (at 230 V, 50 Hz, full load)	Output power range	λ at full load ^①	Efficiency at full load ^①	λ over full operating range (min.) ^③	Efficiency at min. load ^①	Min. forward voltage	Max. forward voltage	Max. output voltage (U-OUT)	Max. peak output current ^③	Max. casing temperature t_c
LC 35/250/140 fixC Ip SNC2	250 mA	170 mA	38.2 W	37.5 W	17.5 – 35.0 W	0.95	91.0 %	0.9C	89.0 %	70.0 V	140 V	320 V	293 mA	70 °C
LC 35/300/121 fixC Ip SNC2	300 mA	180 mA	39.4 W	39.1 W	18.3 – 36.3 W	0.95	90.5 %	0.9C	87.5 %	60.5 V	121 V	320 V	352 mA	70 °C
LC 35/350/104 fixC Ip SNC2	350 mA	180 mA	40.3 W	39.6 W	18.2 – 36.4 W	0.95	90.0 %	0.9C	87.0 %	52.0 V	104 V	320 V	411 mA	70 °C

① Test result at 230 V, 50 Hz.

② Output current is mean value.

③ The trend between min. and full load is linear.

1. Standards

EN 55015
 EN 61000-3-2
 EN 61000-3-3
 EN 61347-1
 EN 61347-2-13
 EN 61547
 EN 62384

2. Thermal details and lifetime

2.1 Expected lifetime

Expected lifetime				
Type	ta	40 °C	50 °C	60 °C
LC 35/250/140 fixC Ip SNC2	tc	60 °C	70 °C	x
	Lifetime	100,000h	50,000h	x
LC 35/300/121 fixC Ip SNC2	tc	60 °C	70 °C	x
	Lifetime	100,000h	50,000h	x
LC 35/350/104 fixC Ip SNC2	tc	60 °C	70 °C	x
	Lifetime	100,000h	50,000h	x

The LED driver is designed for a lifetime stated above under reference conditions and with a failure probability of less than 10 %.

The relation of tc to ta temperature depends also on the luminaire design. If the measured tc temperature is approx. 5 K below tc max., ta temperature should be checked and eventually critical components (e.g. ELCAP) measured. Detailed information on request.

3. Installation / wiring

3.1 Circuit diagram

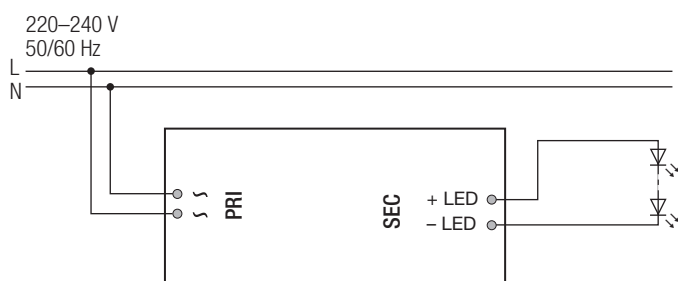

3.2 Wiring type and cross section

The wiring can be stranded wires with ferrules or rigid wires with a cross section of 0.5 – 1.5 mm².

Strip 8.5 – 9.5 mm of insulation from the cables to ensure perfect operation of the push-wire terminals (WAGO 250).

wire preparation:
0.5 – 1.5 mm²

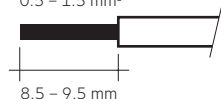

3.3 Release of the wiring

Press down the “push button” and remove the cable from front.

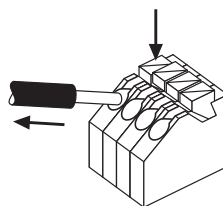

3.4 Wiring guidelines

- All connections must be kept as short as possible to ensure good EMI behaviour.
- Mains leads should be kept apart from LED driver and other leads (ideally 5 – 10 cm distance)
- Max. length of output wires is 2 m.
- Incorrect wiring can damage LED modules.
- To avoid the damage of the Driver, the wiring must be protected against short circuits to earth (sharp edged metal parts, metal cable clips, louver, etc.).

3.5 Earth connection

The earth connection is conducted as protection earth (PE). The LED driver can be earthed via metal housing. If the LED driver will be earthed, protection earth (PE) has to be used. There is no earth connection required for the functionality of the LED driver. Earth connection is recommended to improve following behaviour.

- Electromagnetic interferences (EMI)
- Transmission of mains transients to the LED output

In general it is recommended to earth the LED driver if the LED module is mounted on earthed luminaire parts respectively heat sinks and thereby representing a high capacity against earth.

For Class I application, protection earth need to connected with the metal housing (bottom part).

For Class II application, protection earth is no need to be connected, below 2 scenarios should be considered:

- If the LED driver housing is screw on a metal part inside the luminaires, both LED driver and LED module must be insulated.
- If the LED driver housing is screw on a plastic part inside the luminaires, the LED module need to be insulated.

3.6 Installation instructions

The LED module and all contact points within the wiring must be sufficiently insulated against 4 kV surge voltage.

Air and creepage distance must be maintained.

3.7 Replace LED module

1. Mains off
2. Remove LED module
3. Wait for 30 seconds
4. Connect LED module again

Hot plug-in or output switching of LEDs is not permitted and may cause a very high current to the LEDs.

3.8 Mounting of device

Max. torque for fixing: 0.5 Nm/M4

4. Electrical values

4.1 LC 35W 250mA fixC Ip SNC2

4.1.1 Efficiency vs load

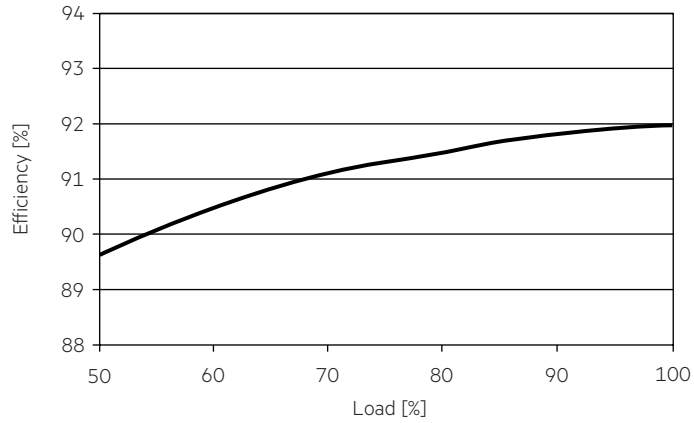

4.1.4 Input current vs load

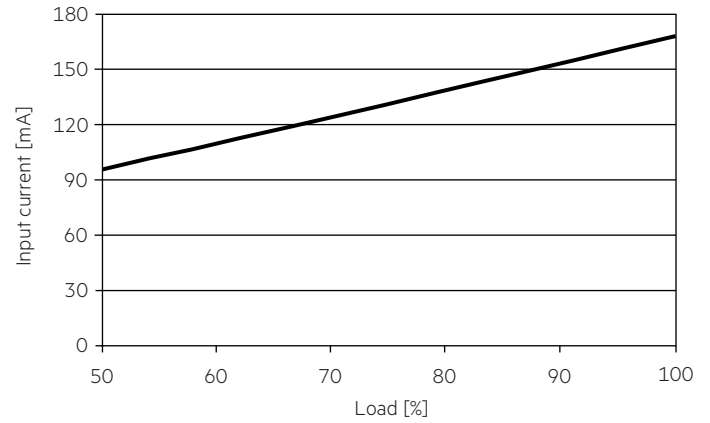

4.1.2 Power factor vs load

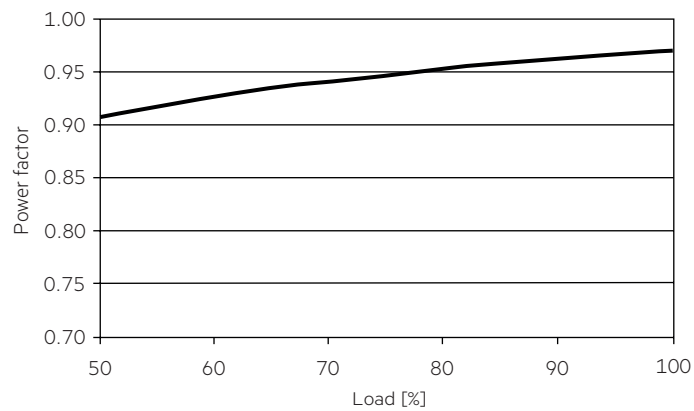

4.1.5 THD vs load (without harmonic < 5 mA or 0.6 % of the input current)

THD without harmonic < 5 mA (0.6 %) of the input current:

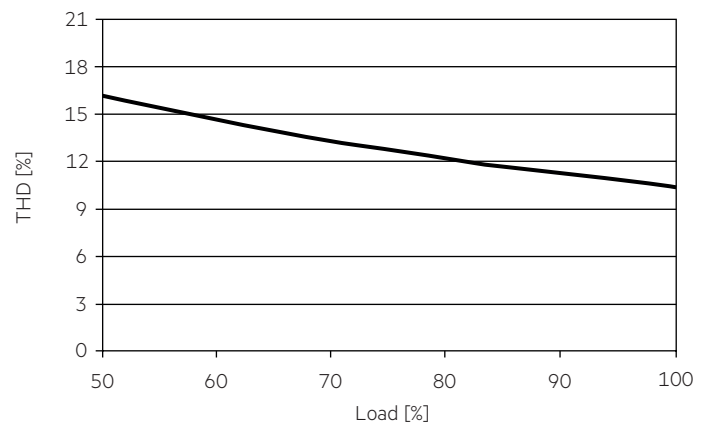

4.1.3 Input power vs load

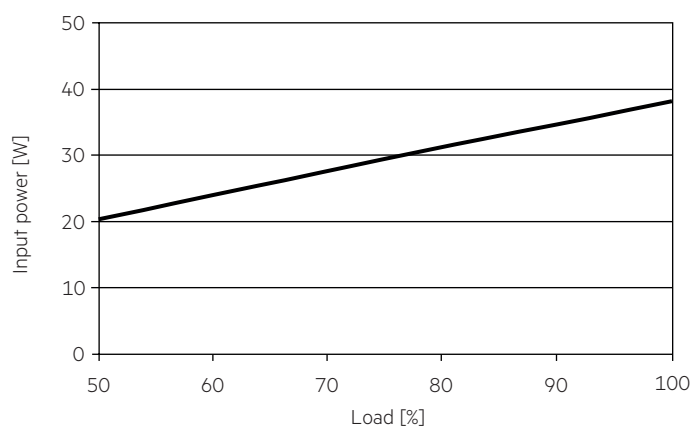

4.2 LC 35W 300mA fixC Ip SNC2

4.2.1 Efficiency vs load

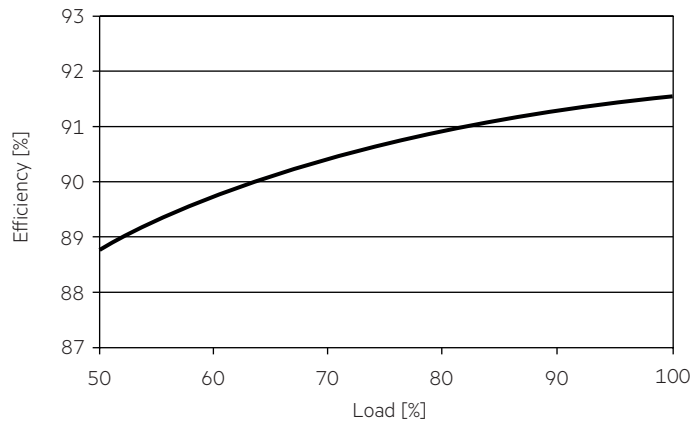

4.2.4 Input current vs load

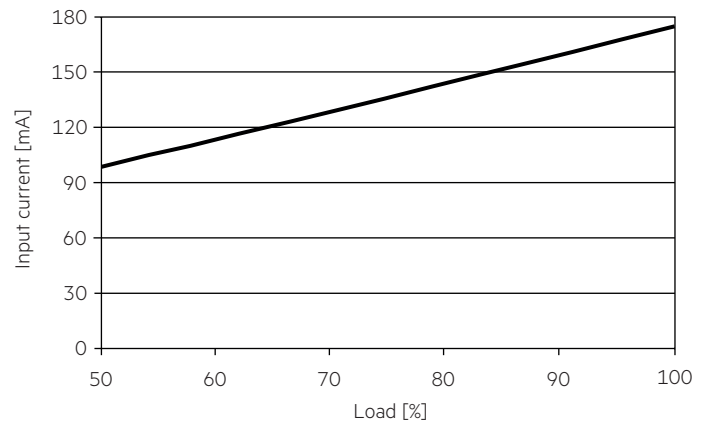

4.2.2 Power factor vs load

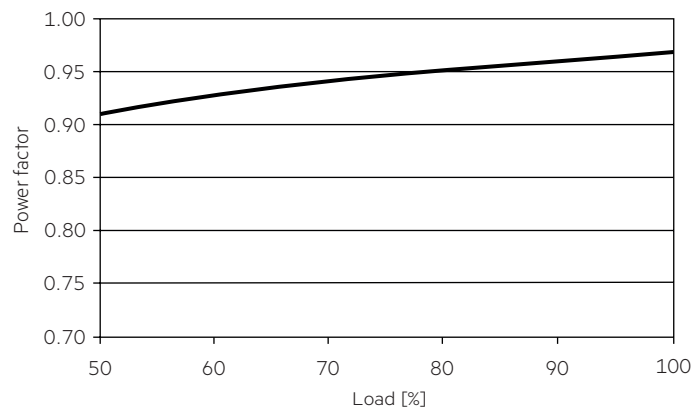

4.2.5 THD vs load (without harmonic < 5 mA or 0.6 % of the input current)

THD without harmonic < 5 mA (0.6 %) of the input current:

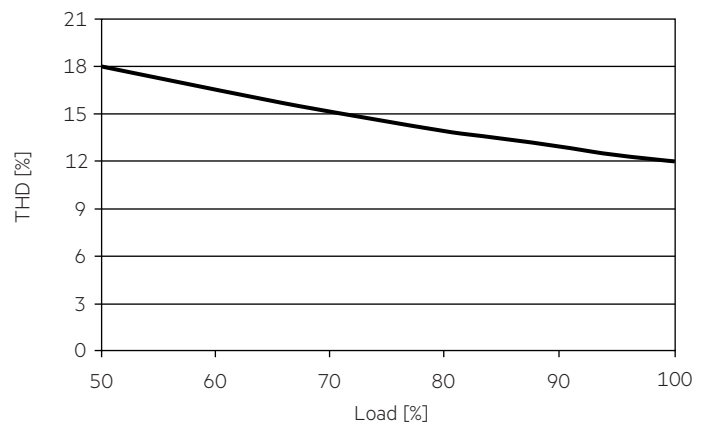

4.2.3 Input power vs load

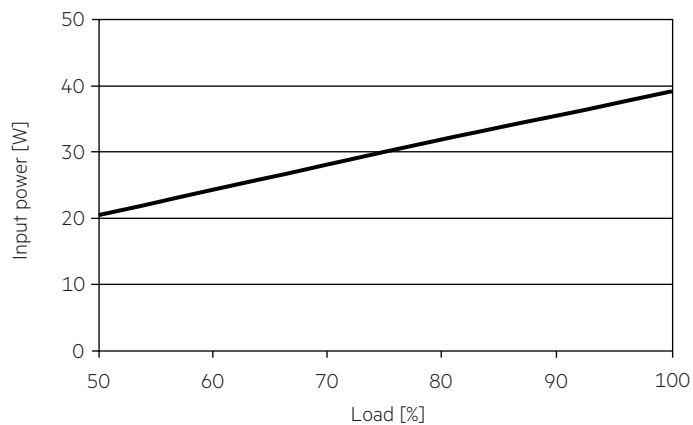

4.3 LC 35W 350mA fixC Ip SNC2

4.3.1 Efficiency vs load

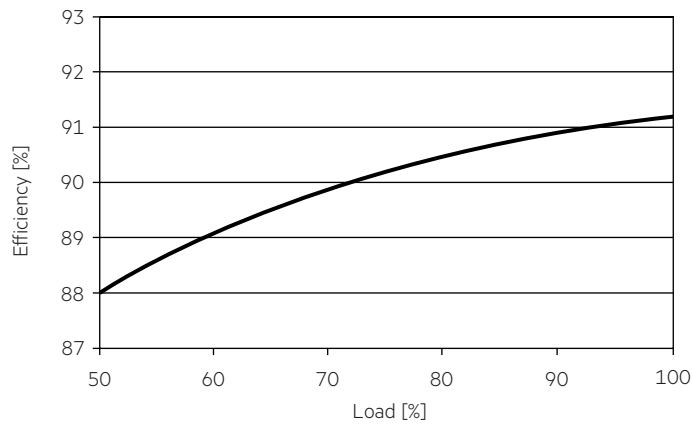

4.3.4 Input current vs load

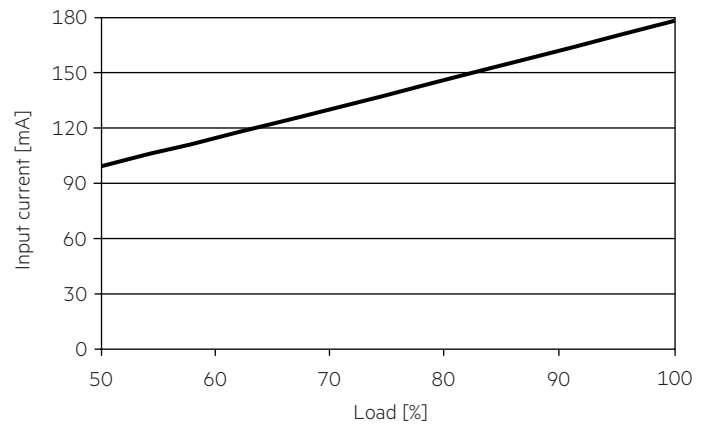

4.3.2 Power factor vs load

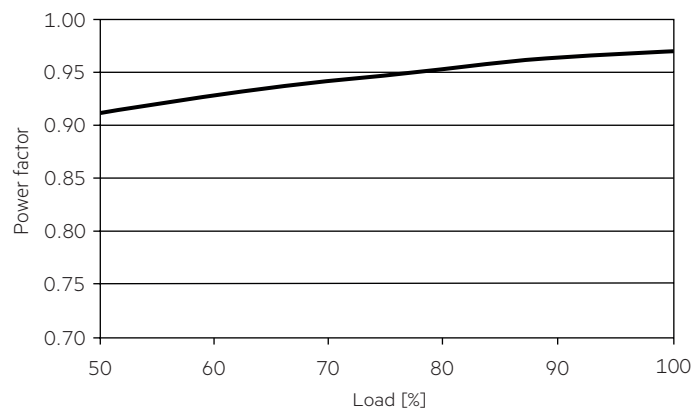

4.3.5 THD vs load (without harmonic < 5 mA or 0.6 % of the input current)

THD without harmonic < 5 mA (0.6 %) of the input current:

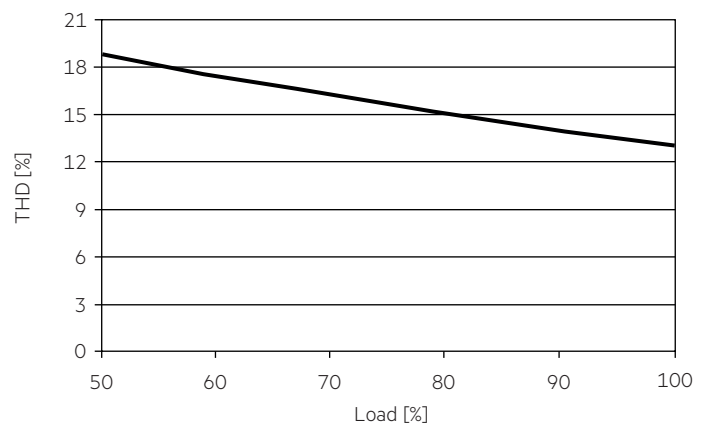

4.3.3 Input power vs load

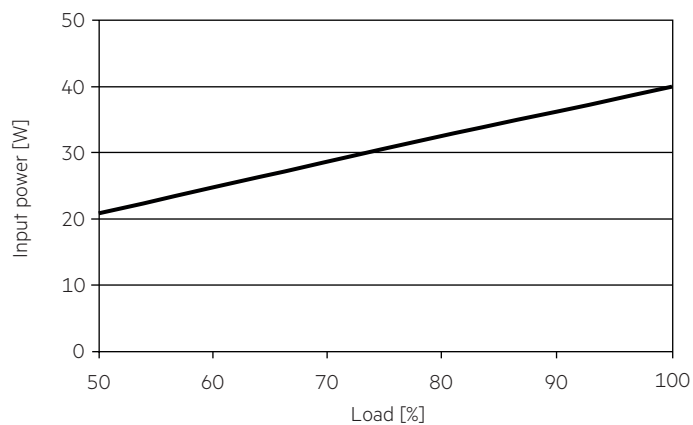

4.4 Maximum loading of automatic circuit breakers in relation to inrush current

Automatic circuit breaker type	C10	C13	C16	C20	B10	B13	B16	B20	Inrush current	
Installation Ø	1.5 mm ²	1.5 mm ²	1.5 mm ²	2.5 mm ²	1.5 mm ²	1.5 mm ²	1.5 mm ²	2.5 mm ²	I _{max}	Time
LC 35/250/140 fixC Ip SNC2	41	53	65	82	41	53	65	82	5.5 A	20 µs
LC 35/300/121 fixC Ip SNC2	41	53	65	82	41	53	65	82	5.5 A	20 µs
LC 35/350/104 fixC Ip SNC2	41	53	65	82	41	53	65	82	5.5 A	20 µs

These are max. values calculated out of continuous current running the device on full load.

There is no limitation due to inrush current.

If load is smaller than full load for calculation only continuous current has to be considered.

4.5 Harmonic distortion in the mains supply (at 230 V / 50 Hz and full load) in %

	THD	3.	5.	7.	9.	11.
LC 35/250/140 fixC Ip SNC2	< 15	< 15	< 5	< 5	< 5	< 3
LC 35/300/121 fixC Ip SNC2	< 15	< 15	< 5	< 5	< 5	< 3
LC 35/350/104 fixC Ip SNC2	< 15	< 15	< 5	< 5	< 5	< 3

Acc. to 6100-3-2. Harmonics < 5 mA or < 0.6 % (whatever is greater) of the input current are not considered for calculation of THD.

5. Functions

5.1 Short-circuit behaviour

In case of a short circuit on the output side (LED) the LED driver switches into hic-cup mode. After elimination of the short-circuit fault the LED driver will recover automatically.

5.2 No-load operation

The LED driver works in burst working mode to provide a constant output voltage regulation which allows the application to be able to work safely when LED string opens due to a failure.

5.3 Overload protection

If the maximum load is exceeded by a defined internal limit, the LED driver will protect itself and LED may flicker. After elimination of the overload, the nominal operation is restored automatically.

6. Miscellaneous

6.1 Insulation and electric strength testing of luminaires

Electronic devices can be damaged by high voltage. This has to be considered during the routine testing of the luminaires in production.

According to IEC 60598-1 Annex Q (informative only!) or ENEC 303-Annex A, each luminaire should be submitted to an insulation test with 500 V_{DC} for 1 second. This test voltage should be connected between the interconnected phase and neutral terminals and the earth terminal.

The insulation resistance must be at least 2 MΩ.

As an alternative, IEC 60598-1 Annex Q describes a test of the electrical strength with 1500 V_{AC} (or 1.414 x 1500 V_{DC}). To avoid damage to the electronic devices this test must not be conducted.

6.2 Conditions of use and storage

Humidity: 5 % up to max. 85 %, not condensed (max. 56 days/year at 85 %)

Storage temperature: -40 °C up to max. +80 °C

The devices have to be within the specified temperature range (ta) before they can be operated.

The LED driver is declared as inbuilt LED controlgear, meaning it is intended to be used within a luminaire enclosure.

If the product is used outside a luminaire, the installation must provide suitable protection for people and environment (e.g. in illuminated ceilings).

6.3 Maximum number of switching cycles

All LED driver are tested with 50,000 switching cycles.

6.4 Additional information

Additional technical information at www.tridonic.com → Technical Data

Lifetime declarations are informative and represent no warranty claim. No warranty if device was opened.