

Driver LC 34W 650-800mA flexC T SNC3

essence in-track series (3-phase system)



Black (RAL 9005)



White (RAL 9010)



Grey (RAL 7035)

Product description

- _ Constant current / in-track LED driver
- _ Optional accessory ACU ALU NIPPLE M10x1 for mounting the luminaire head
- _ Compatible 3-phase system in-tracks, see data sheet chapter 3.8
- _ For luminaires of protection class II
- _ Temperature protection as per EN 61347-2-13 C5e
- _ Selectable fixed output current via DIP switch 800, 750, 700 and 650 mA (pre-selected current 650 mA)
- _ Max. output power 33.6 W
- _ Up to 87.5 % efficiency
- _ Nominal lifetime up to 100,000 h
- _ 5 years guarantee (conditions at <https://www.tridonic.com/manufacture-guarantee-conditions>)

Housing properties

- _ Casing: polycarbonate, black, white or grey
- _ Type of protection IP20

Functions

- _ Overload protection
- _ Short-circuit protection
- _ No-load protection

Typical applications

- _ For spot light in retail and hospitality application

Website

<http://www.tridonic.com/87501013>



Spotlights



Downlights



Linear



Area



Floor | Wall



Free-standing



Street



Decorative



High bay

Specific technical data

Type	Output current ^④	Min. output voltage	Max. output voltage	Max. output power	Typ. power consumption (at 230 V, 50 Hz, full load)	Typ. current consumption (at 230 V, 50 Hz, full load)	t _c point max.	Ambient temperature t _a	I-out select
LC 34/650-800/42 flexC T-B SNC3	650 mA	24 V	42 V	27.3 W	31.5 W	145 mA	60 °C	-20 ... +35 °C	1=off / 2=off
LC 34/650-800/42 flexC T-B SNC3	700 mA	24 V	42 V	29.4 W	33.5 W	155 mA	60 °C	-20 ... +35 °C	1=off / 2=on
LC 34/650-800/42 flexC T-B SNC3	750 mA	24 V	42 V	31.5 W	36.5 W	165 mA	65 °C	-20 ... +35 °C	1=on / 2=off
LC 34/650-800/42 flexC T-B SNC3	800 mA	24 V	42 V	33.6 W	39.0 W	170 mA	65 °C	-20 ... +35 °C	1=on / 2=on
LC 34/650-800/42 flexC T-W SNC3	650 mA	24 V	42 V	27.3 W	31.5 W	145 mA	60 °C	-20 ... +35 °C	1=off / 2=off
LC 34/650-800/42 flexC T-W SNC3	700 mA	24 V	42 V	29.4 W	33.5 W	155 mA	60 °C	-20 ... +35 °C	1=off / 2=on
LC 34/650-800/42 flexC T-W SNC3	750 mA	24 V	42 V	31.5 W	36.5 W	165 mA	65 °C	-20 ... +35 °C	1=on / 2=off
LC 34/650-800/42 flexC T-W SNC3	800 mA	24 V	42 V	33.6 W	39.0 W	170 mA	65 °C	-20 ... +35 °C	1=on / 2=on
LC 34/650-800/42 flexC T-G SNC3	650 mA	24 V	42 V	27.3 W	31.5 W	145 mA	60 °C	-20 ... +35 °C	1=off / 2=off
LC 34/650-800/42 flexC T-G SNC3	700 mA	24 V	42 V	29.4 W	33.5 W	155 mA	60 °C	-20 ... +35 °C	1=off / 2=on
LC 34/650-800/42 flexC T-G SNC3	750 mA	24 V	42 V	31.5 W	36.5 W	165 mA	65 °C	-20 ... +35 °C	1=on / 2=off
LC 34/650-800/42 flexC T-G SNC3	800 mA	24 V	42 V	33.6 W	39.0 W	170 mA	65 °C	-20 ... +35 °C	1=on / 2=on

① Maximum of "perception and reaction" and "let go" values according to EN 60598-1.

② Test result at 25 °C.

③ Test result at max. current.

④ Output current is mean value.

ACU ALU NIPPLE M10x1

Accessory

**Product description**

- _ Optional threaded sleeve for luminaire mounting
- _ Suitable for S-9009/D-M10 threaded nut
- _ Additional mounting equipment, e.g. M13x1 available at AAG Stucchi (<http://www.aagstucchi.it/en/>)

Website

<http://www.tridonic.com/28002398>

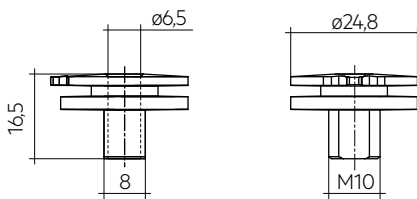
**Ordering data**

Type	Article number	Packaging, bag	Weight per pc.
ACU ALU NIPPLE M10x1	28002398	100 pc(s).	0.007 kg

1. Standards

EN 55015
 EN 61000-3-2
 EN 61000-3-3
 EN 61347-1
 EN 61347-2-13
 EN 61547
 EN 61000-4-4
 EN 61000-4-5

1.1 Glow-wire test

According to EN 61347-1 with increased temperature of 850 °C passed.

2. Thermal details and lifetime

2.1 Expected lifetime

Expected lifetime				
Type	Output current	ta	25 °C	35 °C
LC 34/650-800/42 flexC T SNC3	650 mA	Lifetime	> 100,000 h	> 50,000 h
	700 mA	Lifetime	> 100,000 h	> 50,000 h
	750 mA	Lifetime	> 100,000 h	> 50,000 h
	800 mA	Lifetime	> 100,000 h	> 50,000 h

The LED drivers are designed for a lifetime stated above under reference conditions and with a failure probability of less than 10 %.

Temperatures were measured with Tracktype PRO-310 from manufacturer powergear. Temperatures can deviate with tracks from other manufacturers.

3. Installation / wiring

3.1 Circuit diagram

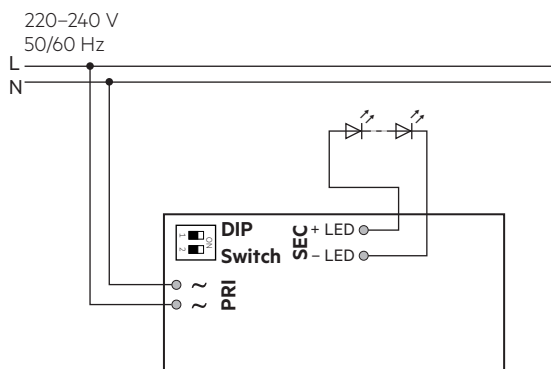

3.2 Wiring type and cross section

For wiring use stranded wire with ferrules or solid wire from 0.5–1.5 mm². Strip 8.5–9.5 mm of insulation from the cables to ensure perfect operation of the push-wire terminals.

Use one wire for each terminal connector only.

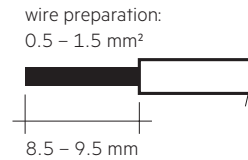

3.3 Release of the wiring

Press down the “push button” and remove the cable from front.

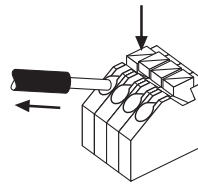

3.4 Fixing conditions

Dry, acidfree, oilfree, fatfree. It is not allowed to exceed the maximum ambient temperature (ta) stated on the device.

3.5 Wiring guidelines

- All connections must be kept as short as possible to ensure good EMI behaviour.
- Max. length of output wires is 20 cm.
- Secondary switching is not permitted.
- Incorrect wiring can damage LED modules.
- To avoid the damage of the Driver, the wiring must be protected against short circuits to earth (sharp edged metal parts, metal cable clips, louver, etc.).

3.6 Replace LED module

1. Mains off
2. Remove LED module
3. Wait for 30 seconds
4. Connect LED module again

Hot plug-in or secondary switching of LEDs is not permitted and may cause a very high current to the LEDs.

3.7 Mounting luminaire

Max. allowed weight of complete luminaire: 5 kg (50 N)

3.8 Compatible tracks

Subject to be changed without notice.

Manufacturer	Type	System	Intrack casing colour
EUTRAC	25-XX-XX / 26-XX-XX	3P	Black, white, grey
iGuzzini	6771-6774	3P	Black, white, grey
iGuzzini	6779-6782	3P	Black, white, grey
IVELA	7501 / 7511 / 7512	3P	Black, white, grey
LUMISYS UNIPRO	T32 / T33 /34	3P	Black, white, grey
LUMISYS UNIPRO	T32F / T33F /34F	3P	Black, white, grey
NORDIC ALUMINIUM	GLOBAL Trac Pro XTS 4xxx	3P	Black, white, grey
NORDIC ALUMINIUM	GLOBAL Trac Pro XTSF 4xxx	3P	Black, white, grey
ZUMTOBEL	S280...	3P	Black, white, grey
ERCO	783...	3P	Black, white, grey
SIDE	25101	3P	Black, white, grey
PHILIPS	RCS350 3C	3P	Black, white, grey
FOSNOVA	OMNITRACK	3P	Black, white, grey
Stucchi	One track	3P	Black, white, grey
Powergear	PRO-04X0	3P	Black, white, grey
Unipro	T32W	3P	Black, white, grey
Unipro	T32FW	3P	Black, white, grey

Tests have been done with in-tracks taken from the market in the first half of 2020.



Tridonic has no control or responsibility on any future or past possible changes made by different manufactures that could affect the compatibility between tracks and adapters.

3.9 Adapter mounting into the track

Insert the adapter into the track, so that the mechanical key (A) in the adaptor matches the groove (B) in the track. Rotate of about 90° the lever of the cam (C) until it reaches the locking position.

To open rotate the lever the opposite direction.

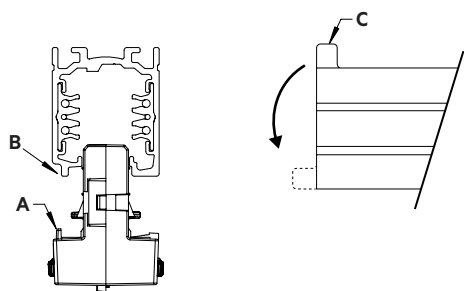

3.10 Phase selection

When the track is connected to a three-phase system it is possible to select the phase (L1, L2 or L3) to distribute the single luminaires in the system, by means of the proper selector (A) of the adaptor.

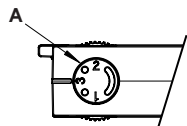

3.11 Current setting



Set the current by DIP switch after mains off. Use of DIP switch only after mains off.

650 mA: Switch 1 = Off, Switch 2 = Off

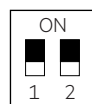

700 mA: Switch 1 = Off, Switch 2 = On

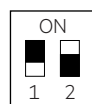

750 mA: Switch 1 = On, Switch 2 = Off



800 mA: Switch 1 = On, Switch 2 = On

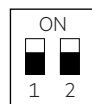

4. Electrical values

4.1 Efficiency vs load

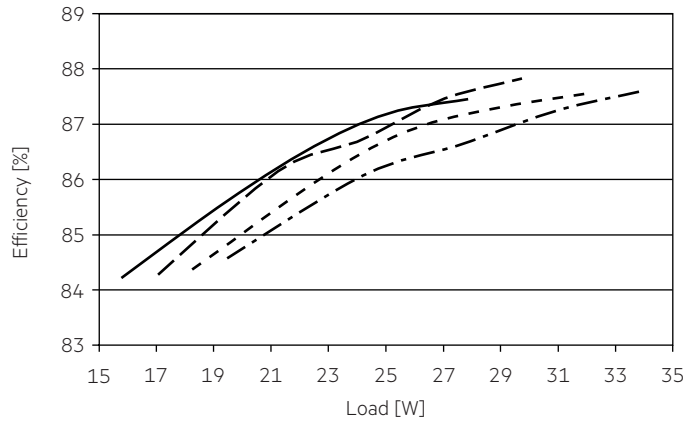

4.2 Power factor vs load

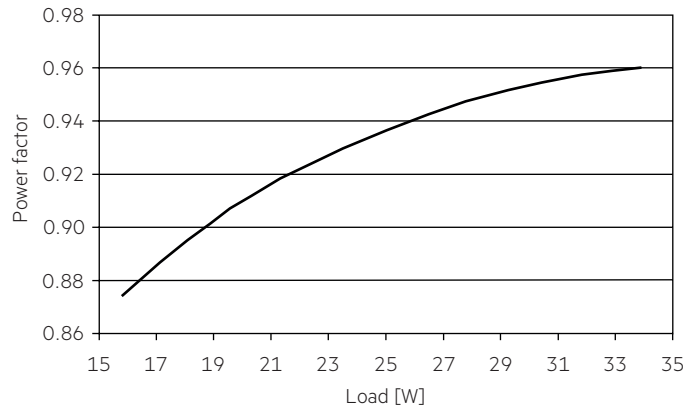

4.3 THD vs load

THD without harmonic < 5 mA (0.6 %) of the input current:

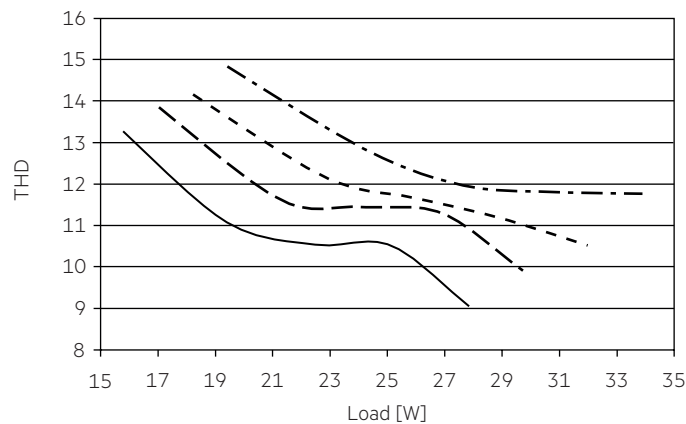

- 650 mA
- - - 700 mA
- - - - 750 mA
- · - · - 800 mA

4.6 Maximum loading of automatic circuit breakers in relation to inrush current

Automatic circuit breaker type	C10	C13	C16	C20	B10	B13	B16	B20	Inrush current	
Installation Ø	1.5 mm ²	1.5 mm ²	2.5 mm ²	2.5 mm ²	1.5 mm ²	1.5 mm ²	2.5 mm ²	2.5 mm ²	I _{max}	Time
LC 34/650-800/42 flexC T SNC3	45	60	75	95	45	60	75	95	4 A	50 µs

These are max. values calculated out of inrush current! Please consider not to exceed the maximum rated continuous current of the circuit breaker. Calculation uses typical values from ABB series S200 as a reference. Actual values may differ due to used circuit breaker types and installation environment.

4.7 Harmonic distortion in the mains supply (at 230 V / 50 Hz and full load) in %

	THD	3.	5.	7.	9.	11.
LC 34/650-800/42 flexC T SNC3	< 15	< 15	< 10	< 5	< 5	< 3

Acc. to 61000-3-2. Harmonics < 5 mA or < 0.6 % (whatever is greater) of the input current are not considered for calculation of THD.

5. Functions

5.1 Short-circuit behaviour

In case of a short circuit on the secondary side (LED) the LED driver switches off. After elimination of the short-circuit fault the LED driver will recover automatically.

5.2 No-load operation

The LED driver works in burst working mode to provide a constant output voltage regulation which allows the application to be able to work safely when LED string opens due to a failure.

5.3 Overload protection

If the maximum load is exceeded by a defined internal limit, the LED driver will protect itself and LED may flicker. After elimination of the overload the nominal operation will recover automatically.

6. Miscellaneous

6.1 Insulation and electric strength testing of luminaires

Electronic devices can be damaged by high voltage. This has to be considered during the routine testing of the luminaires in production.

According to IEC 60598-1 Annex Q (informative only!) or ENEC 303-Annex A, each luminaire should be submitted to an insulation test with 500 V_{DC} for 1 second. This test voltage should be connected between the interconnected phase and neutral terminals and the earth terminal. The insulation resistance must be at least 2 MΩ.

As an alternative, IEC 60598-1 Annex Q describes a test of the electrical strength with 1500 V_{AC} (or 1.414 x 1500 V_{DC}). To avoid damage to the electronic devices this test must not be conducted.

6.2 Conditions of use and storage

Humidity: 5 % up to max. 85 %, not condensed (max. 56 days/year at 85 %)

Storage temperature: -40 °C up to max. +80 °C

The devices have to be within the specified temperature range (t_a) before they can be operated.

6.3 Maximum number of switching cycles

All LED driver are tested with 50,000 switching cycles.

6.4 Additional information

Additional technical information at www.tridonic.com → Technical Data

Lifetime declarations are informative and represent no warranty claim. No warranty if device was opened.