

Driver LC 25W 350-600mA 42V flexC T ADV

advanced in-track series



Black (RAL 9005)



White (RAL 9010)



Grey (RAL 7035)

Product description

- _ Constant current / in-track LED driver
- _ Optional accessory ACU ALU NIPPLE M10x1 for mounting the luminaire head
- _ Compatible 3-phase system in-tracks, see data sheet chapter 3.8
- _ For luminaires of protection class II
- _ Temperature protection as per EN 61347-2-13 C5e
- _ Adjustable output current between 350 and 600 mA via I-SELECT 2 plugs
- _ Max. output power 25 W
- _ Up to 84 % efficiency
- _ Nominal lifetime up to 100,000 h
- _ 5 years guarantee (conditions at <https://www.tridonic.com/en/int/services/manufacturer-guarantee-conditions>)

Housing properties

- _ Casing: polycarbonate, black, white or grey
- _ Type of protection IP20

Functions

- _ Overtemperature protection
- _ Overload protection
- _ Short-circuit protection
- _ No-load protection
- _ Burst protection voltage 2 kV
- _ Surge protection voltage 1 kV (L to N)

Typical applications

- _ For spot light in retail and hospitality application

Website

<http://www.tridonic.com/87500787>



Linear



High bay



Decorative



Downlights



Spotlights



Free-standing



Area



Floor | Wall



Street

Driver LC 25W 350-600mA 42V flexC T ADV

advanced in-track series

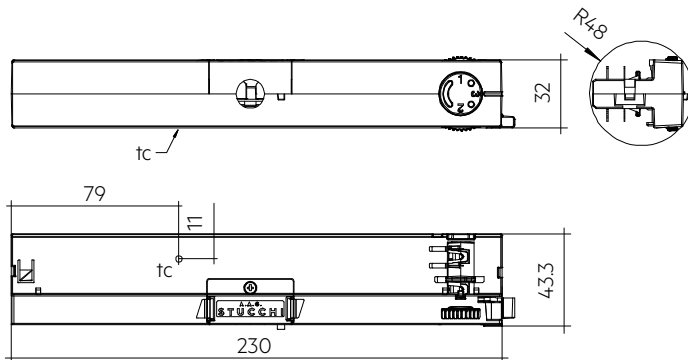

Ordering data

Type	Article number	Colour	Packaging, carton	Packaging, low volume	Packaging, high volume	Weight per pc.
LC 25/350-600/42 flexC T-B ADV	87500787	Black	10 pc(s).	90 pc(s).	1,440 pc(s).	0.141 kg
LC 25/350-600/42 flexC T-W ADV	87500789	White	10 pc(s).	90 pc(s).	1,440 pc(s).	0.142 kg
LC 25/ 350-600/42 flexC T-G ADV	87500904	Grey	10 pc(s).	90 pc(s).	1,440 pc(s).	0.141 kg

Technical data

Rated supply voltage	220 – 240 V
AC voltage range	198 – 264 V
Max. input current (at 230 V, 50 Hz, full load)	0.139 A
Leakage current (at 230 V, 50 Hz, full load)	< 450 µA
Mains frequency	50 / 60 Hz
Overvoltage protection	320 V AC, 1 h
Max. input power ^①	30.1 W
Typ. power consumption (at 230 V, 50 Hz, full load) ^①	29.7 W
Min. output power	4.2 W
Max. output power	25 W
Typ. efficiency (at 230 V, 50 Hz, full load) ^①	83 %
λ (at 230 V, 50 Hz, full load) ^①	0.95
Output current tolerance ^②	± 5 %
Max. output current peak ^③	≤ output current + 10 %
Max. output voltage (U-OUT)	60 V
THD (at 230 V, 50 Hz, full load) ^①	< 10 %
Output LF current ripple (< 120 Hz)	± 3 %
Output P_ST_LM (at full load)	≤ 1
Output SVM (at full load)	≤ 0.4
Starting time (at 230 V, 50 Hz, full load)	< 0.5 s
Turn off time (at 230 V, 50 Hz, full load)	≤ 0.01 s
Hold on time at power failure (output)	0 s
Ambient temperature t _a (at lifetime 50,000 h)	35 °C
Storage temperature t _s	-40 ... +80 °C
Mains surge capability (between L - N)	1 kV
Lifetime	up to 100,000 h
Guarantee (conditions at www.tridonic.com)	5 Year(s)
Dimensions L x W x H	230 x 32 x 43.3 mm

Approval marks



Standards

EN 55015, EN 61000-3-2, EN 61000-3-3, EN 61347-1, EN 61347-2-13, EN 61547, EN 62384

Specific technical data

Type	Output current ^②	Min. output voltage	Max. output voltage	Max. output power	Typ. power consumption (at 230 V, 50 Hz, full load)	Typ. current consumption (at 230 V, 50 Hz, full load)	t _c point max.	Ambient temperature T _a	I-SELECT 2 resistor value ^⑤
LC 25/350-600/42 flexC T-B ADV	350 mA	12 V	42 V	14.7 W	17.9 W	84 mA	80 °C	-20 ... +35 °C	-
LC 25/350-600/42 flexC T-B ADV	400 mA	12 V	42 V	16.8 W	20.2 W	92 mA	80 °C	-20 ... +35 °C	12.40 kΩ
LC 25/350-600/42 flexC T-B ADV	450 mA	12 V	42 V	18.9 W	22.5 W	102 mA	80 °C	-20 ... +35 °C	11.00 kΩ
LC 25/350-600/42 flexC T-B ADV	500 mA	12 V	42 V	21.0 W	24.9 W	112 mA	80 °C	-20 ... +35 °C	10.00 kΩ
LC 25/350-600/42 flexC T-B ADV	550 mA	12 V	42 V	23.1 W	27.3 W	122 mA	80 °C	-20 ... +35 °C	9.09 kΩ
LC 25/350-600/42 flexC T-B ADV	600 mA	12 V	42 V	25.2 W	29.7 W	132 mA	80 °C	-20 ... +35 °C	0.00 kΩ
LC 25/350-600/42 flexC T-W ADV	350 mA	12 V	42 V	14.7 W	17.9 W	84 mA	80 °C	-20 ... +35 °C	-
LC 25/350-600/42 flexC T-W ADV	400 mA	12 V	42 V	16.8 W	20.2 W	92 mA	80 °C	-20 ... +35 °C	12.40 kΩ
LC 25/350-600/42 flexC T-W ADV	450 mA	12 V	42 V	18.9 W	22.5 W	102 mA	80 °C	-20 ... +35 °C	11.00 kΩ
LC 25/350-600/42 flexC T-W ADV	500 mA	12 V	42 V	21.0 W	24.9 W	112 mA	80 °C	-20 ... +35 °C	10.00 kΩ
LC 25/350-600/42 flexC T-W ADV	550 mA	12 V	42 V	23.1 W	27.3 W	122 mA	80 °C	-20 ... +35 °C	9.09 kΩ
LC 25/350-600/42 flexC T-W ADV	600 mA	12 V	42 V	25.2 W	29.7 W	132 mA	80 °C	-20 ... +35 °C	0.00 kΩ
LC 25/ 350-600/42 flexC T-G ADV	350 mA	12 V	42 V	14.7 W	17.9 W	84 mA	80 °C	-20 ... +35 °C	-
LC 25/ 350-600/42 flexC T-G ADV	400 mA	12 V	42 V	16.8 W	20.2 W	92 mA	80 °C	-20 ... +35 °C	12.40 kΩ
LC 25/ 350-600/42 flexC T-G ADV	450 mA	12 V	42 V	18.9 W	22.5 W	102 mA	80 °C	-20 ... +35 °C	11.00 kΩ
LC 25/ 350-600/42 flexC T-G ADV	500 mA	12 V	42 V	21.0 W	24.9 W	112 mA	80 °C	-20 ... +35 °C	10.00 kΩ
LC 25/ 350-600/42 flexC T-G ADV	550 mA	12 V	42 V	23.1 W	27.3 W	122 mA	80 °C	-20 ... +35 °C	9.09 kΩ
LC 25/ 350-600/42 flexC T-G ADV	600 mA	12 V	42 V	25.2 W	29.7 W	132 mA	80 °C	-20 ... +35 °C	0.00 kΩ

① Test result at 600 mA.

② Output current is mean value.

③ Test result at 25 °C.

④ Device operates down to 4 V output voltage. It cannot be guaranteed that harmonics and EMI stay inside the limits. This has to be checked individually.

⑤ Not compatible with I-SELECT (generation 1). Calculated resistor value.

I-SELECT 2 PLUG PRE / EXC

Accessory

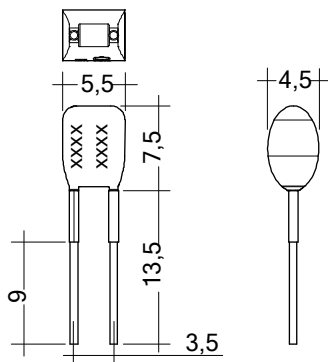

Product description

- _ Ready-for-use resistor to set output current value
- _ Compatible with LED driver featuring I-select 2 interface; not compatible with I-SELECT (generation 1)
- _ Resistor is base insulated
- _ Resistor power 0.25 W
- _ Current tolerance $\pm 2\%$ additional to output current tolerance
- _ Compatible with LED driver series PRE and EXC

Example of calculation

- _ $R [k\Omega] = 5 V / I_{out} [mA] \times 1000$
- _ E96 resistor value used
- _ Resistor value tolerance $\leq 1\%$; resistor power $\geq 0.1 W$; base insulation necessary
- _ When using a resistor value beyond the specified range, the output current will automatically be set to the minimum value (resistor value too big), respectively to the maximum value (resistor value too small)

Website

<http://www.tridonic.com/28001110>



Ordering data

Type	Article number	Colour	Marking	Current	Resistor value	Packaging, bag	Weight per pc.
I-SELECT 2 PLUG 350MA BL	28001110	Blue	0350 mA	350 mA	14.30 k Ω	10 pc(s).	0.001 kg
I-SELECT 2 PLUG 375MA BL	28001111	Blue	0375 mA	375 mA	13.30 k Ω	10 pc(s).	0.001 kg
I-SELECT 2 PLUG 400MA BL	28001112	Blue	0400 mA	400 mA	12.40 k Ω	10 pc(s).	0.001 kg
I-SELECT 2 PLUG 425MA BL	28001251	Blue	0425 mA	425 mA	11.80 k Ω	10 pc(s).	0.001 kg
I-SELECT 2 PLUG 450MA BL	28001113	Blue	0450 mA	450 mA	11.00 k Ω	10 pc(s).	0.001 kg
I-SELECT 2 PLUG 475MA BL	28001252	Blue	0475 mA	475 mA	10.50 k Ω	10 pc(s).	0.001 kg
I-SELECT 2 PLUG 500MA BL	28001114	Blue	0500 mA	500 mA	10.00 k Ω	10 pc(s).	0.001 kg
I-SELECT 2 PLUG 550MA BL	28001115	Blue	0550 mA	550 mA	9.09 k Ω	10 pc(s).	0.001 kg
I-SELECT 2 PLUG MAX BL	28001099	Blue	MAX	MAX	0.00 k Ω	10 pc(s).	0.001 kg

ACU ALU NIPPLE M10x1

Accessory

**Product description**

- _ Optional threaded sleeve for luminaire mounting
- _ Suitable for S-9009/D-M10 threaded nut
- _ Additional mounting equipment, e.g. M13x1 available at AAG Stucchi (<http://www.aagstucchi.it/en/>)

Website

<http://www.tridonic.com/28002398>

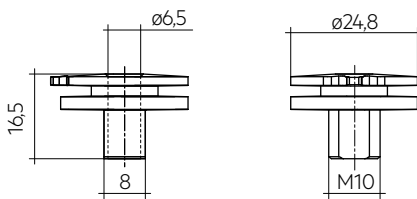
**Ordering data**

Type	Article number	Packaging, bag	Weight per pc.
ACU ALU NIPPLE M10x1	28002398	100 pc(s).	0.007 kg

1. Standards

EN 55015
 EN 61000-3-2
 EN 61000-3-3
 EN 61347-1
 EN 61347-2-13
 EN 61547
 EN 62384

1.1 Glow-wire test

according to EN 61347-1 with increased temperature of 850 °C passed (Black RAL9005/ White RAL9010).

according to EN 61347-1 with increased temperature of 750 °C passed (Grey RAL7035).

2. Thermal details and lifetime

2.1 Expected lifetime

Expected lifetime

Type	ta	25 °C	35 °C
LC 25/350-600/42 flexC T ADV	Lifetime	100,000 h	50,000 h

[®] Test result at max. output voltage.

The LED drivers are designed for a lifetime stated above under reference conditions and with a failure probability of less than 10 %.

3. Installation / wiring

3.1 Circuit diagram

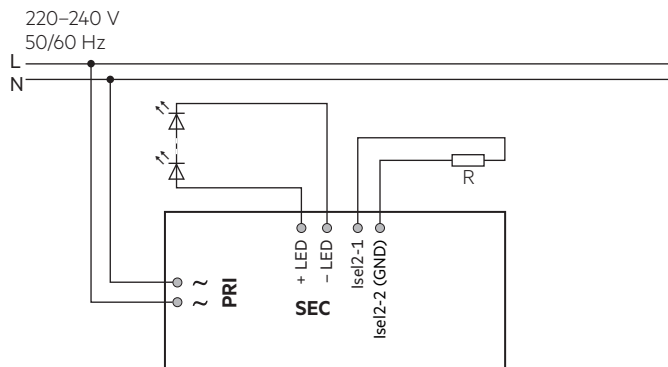

3.2 Wiring type and cross section

For wiring use stranded wire or solid wire from 0.2–0.5 mm². Strip 8.5–9.5 mm of insulation from the cables to ensure perfect operation of the push-wire terminals.

Use one wire for each terminal connector only.

wire preparation:
0.2 – 0.5 mm²

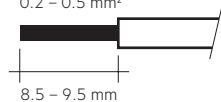

3.3 Release of the wiring

Press down the “push button” and remove the cable from front.

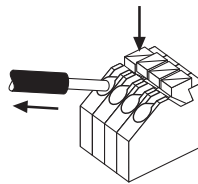

3.4 Fixing conditions

Dry, acidfree, oilfree, fatfree. It is not allowed to exceed the maximum ambient temperature (ta) stated on the device.

3.5 Wiring guidelines

- All connections must be kept as short as possible to ensure good EMI behaviour.
- Max. length of output wires is 20 cm.
- Secondary switching is not permitted.
- Incorrect wiring can damage LED modules.
- To avoid damage of the Driver, the wiring must be protected against short circuits to earth (sharp edged metal parts, metal cable clips, louver, etc.).

3.6 Replace LED module

1. Mains off
2. Remove LED module
3. Wait for 10 seconds
4. Connect LED module again

Hot plug-in or secondary switching of LEDs is not permitted and may cause a very high current to the LEDs.

3.7 Mounting luminaire

Max. allowed weight of complete luminaire: 5 kg (50 N).
 This is valid for horizontal mounting of track system only.
 For vertical installation please contact Tridonic for clarification.

3.8 Compatible tracks

Subject to be changed without notice.

Manufacturer	Type	System	Intrack casing colour
EUTRAC	25-XX-XX / 26-XX-XX	3P	Black, white, grey
iGuzzini	6771-6774	3P	Black, white, grey
iGuzzini	6779-6782	3P	Black, white, grey
IVELA	7501 / 7511 / 7512	3P	Black, white, grey
LUMISYS UNIPRO	T32 / T33 /34	3P	Black, white, grey
LUMISYS UNIPRO	T32F / T33F /34F	3P	Black, white, grey
NORDIC ALUMINIUM	GLOBAL Trac Pro XTS 4xxx	3P	Black, white, grey
NORDIC ALUMINIUM	GLOBAL Trac Pro XTSF 4xxx	3P	Black, white, grey
ZUMTOBEL	S280...	3P	Black, white, grey
ERCO	783...	3P	Black, white, grey
SIDE	25101	3P	Black, white, grey
PHILIPS	RCS350 3C	3P	Black, white, grey
FOSNOVA	OMNITRACK	3P	Black, white, grey
Stucchi	One track	3P	Black, white, grey
Powergear	PRO-0610	3P	Black, white, grey
Unipro	T32W	3P	Black, white, grey
Unipro	T32FW	3P	Black, white, grey

Tests have been done with in-tracks taken from the market in the first half of 2020.



Tridonic has no control or responsibility on any future or past possible changes made by different manufactures that could affect the compatibility between tracks and adapters.

3.9 Adapter mounting into the track

Insert the adapter into the track, so that the mechanical key (A) in the adaptor matches the groove (B) in the track. Rotate of about 90° the lever of the cam (C) until it reaches the locking position.

To open rotate the lever the opposite direction.

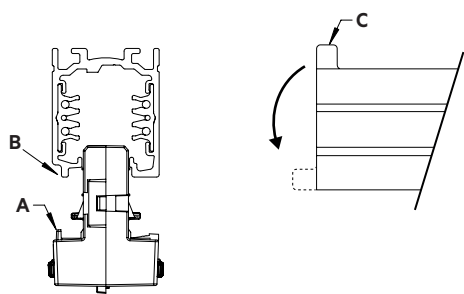

3.10 Phase selection

When the track is connected to a three-phase system it is possible to select the phase (L1, L2 or L3) to distribute the single luminaires in the system, by means of the proper selector (A) of the adaptor.

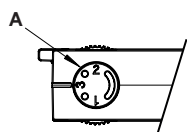

4. Electrical values

4.1 Operating window

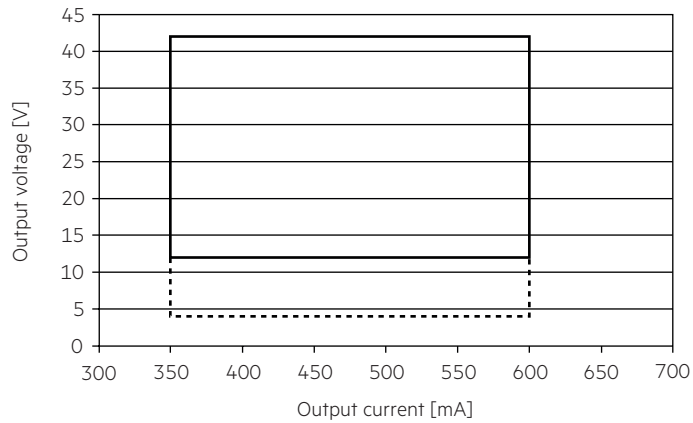

— Operating window
 - - - - - Operating window 4 V

Device operates down to 4 V output voltage. It cannot be guaranteed that harmonics and EMI stay inside the limits. This has to be checked individually.

4.2 Efficiency vs load

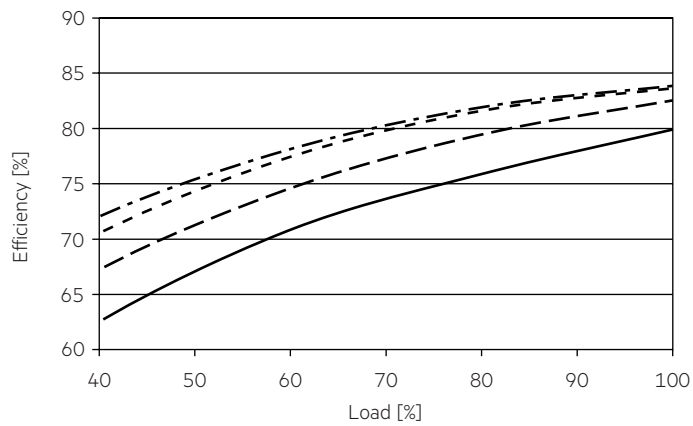

4.3 Power factor vs load

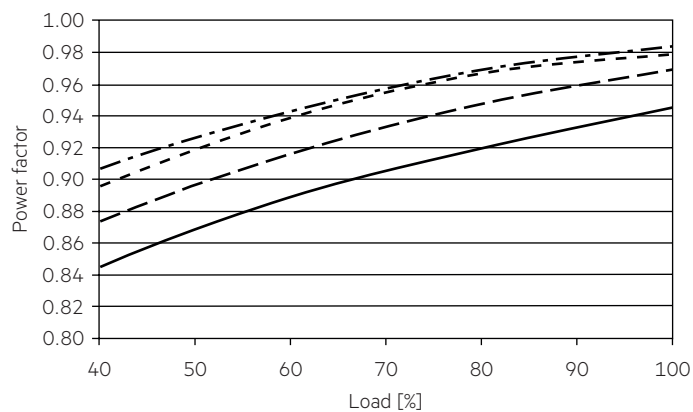

4.4 Input power vs load

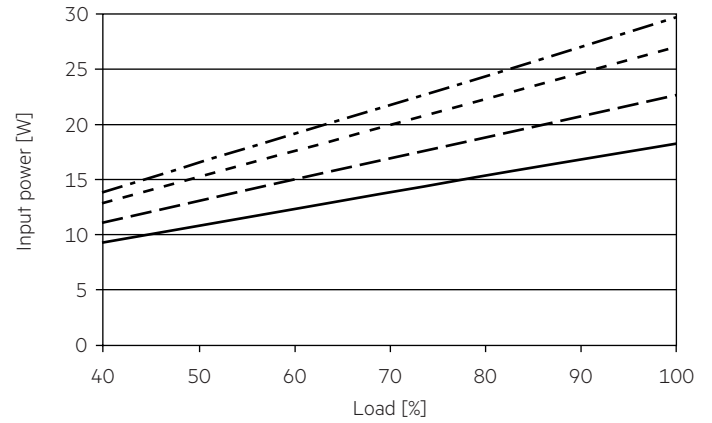

4.5 Input current vs load

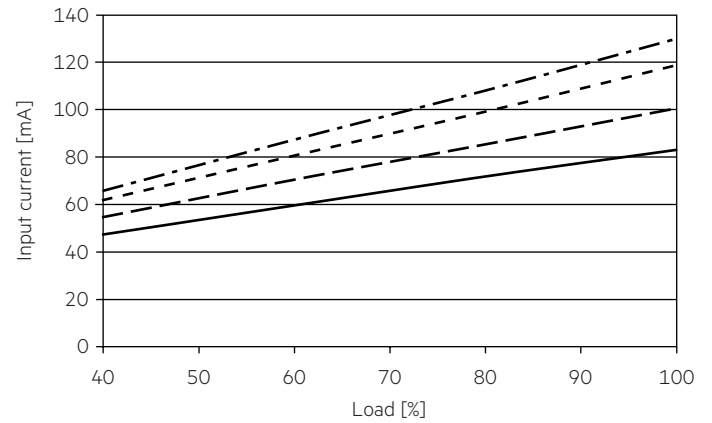

4.6 THD vs load

THD without harmonic < 5 mA (0.6 %) of the input current:

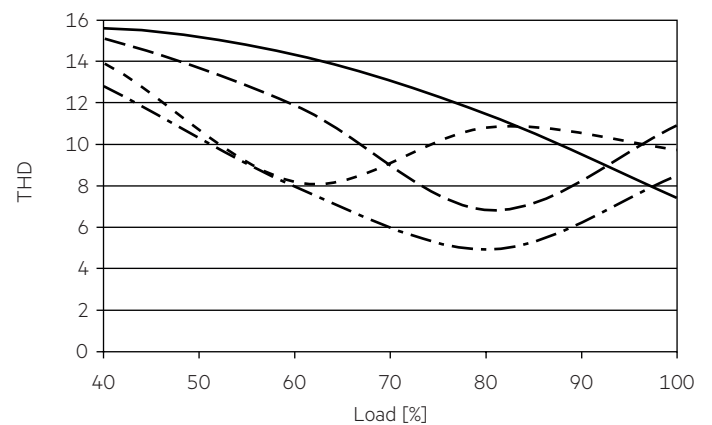

— 350 mA
 - - - - - 450 mA
 - - - - - 550 mA
 - - - - - 600 mA

4.7 Maximum loading of automatic circuit breakers in relation to inrush current

Automatic circuit breaker type	C10	C13	C16	C20	B10	B13	B16	B20	Inrush current	
Installation Ø	1.5 mm ²	1.5 mm ²	1.5 mm ²	2.5 mm ²	1.5 mm ²	1.5 mm ²	1.5 mm ²	2.5 mm ²	I _{max}	Time
LC 25/350-600/42 flexC T-B ADV	58	76	94	117	58	76	94	117	8 A	80 µs

These are max. values calculated out of continuous current running the device on full load.

There is no limitation due to inrush current.

If load is smaller than full load for calculation only continuous current has to be considered.

4.8 Harmonic distortion in the mains supply (at 230 V / 50 Hz and full load) in %

	THD	3.	5.	7.	9.	11.
LC 25/350-600/42 flexC T-B ADV	< 9	< 7	< 5	< 4	< 1	< 2

Acc. to 61000-3-2. Harmonics < 5 mA or < 0.6 % (whatever is greater) of the input current are not considered for calculation of THD.

5. Functions

5.1 Short-circuit behaviour

In case of a short circuit on the secondary side (LED) the LED driver switches off. After elimination of the short-circuit fault the LED driver will recover automatically.

5.2 No-load operation

The LED driver works in burst working mode to provide a constant output voltage regulation which allows the application to be able to work safely when LED string opens due to a failure.

5.3 Overload protection

If the maximum load is exceeded by a defined internal limit, the LED driver will protect itself and LED may flicker. After elimination of the overload the nominal operation will recover automatically.

5.4 Overtemperature protection

The LED driver is protected against temporary thermal overheating.

If the temperature limit is exceeded the LED driver will switch off.

It restarts automatically.

The temperature protection is activated above $t_{c\ max}$.

5.5 Function: adjustable current

The output current of the LED driver can be adjusted in a certain range.

I-SELECT 2

By inserting a suitable resistor or third party resistor into the I-SELECT 2 interface, the current value can be adjusted. The relationship between output current and resistor value can be found in the chapter "Accessories I-SELECT 2 Plugs".



Please note that the resistor values for I-SELECT 2 are not compatible with I-SELECT (generation 1). Installation of an incorrect resistor may cause irreparable damage to the LED module(s).

Resistors for the main output current values can be ordered from Tridonic (see accessories).

6. Miscellaneous

6.1 Insulation and electric strength testing of luminaires

Electronic devices can be damaged by high voltage. This has to be considered during the routine testing of the luminaires in production.

According to IEC 60598-1 Annex Q (informative only!) or ENEC 303-Annex A, each luminaire should be submitted to an insulation test with 500 V_{DC} for 1 second. This test voltage should be connected between the interconnected phase and neutral terminals and the earth terminal. The insulation resistance must be at least 2 MΩ.

As an alternative, IEC 60598-1 Annex Q describes a test of the electrical strength with 1500 V_{AC} (or 1.414 x 1500 V_{DC}). To avoid damage to the electronic devices this test must not be conducted.

6.2 Conditions of use and storage

Humidity: 5 % up to max. 85 %, not condensed (max. 56 days/year at 85 %)

Storage temperature: -40 °C up to max. +80 °C

The devices have to be within the specified temperature range (t_a) before they can be operated.

6.3 Maximum number of switching cycles

All LED driver are tested with 50,000 switching cycles.

6.4 Additional information

Additional technical information at www.tridonic.com → Technical Data

Lifetime declarations are informative and represent no warranty claim. No warranty if device was opened.