

Driver LC 25W 200-350mA stepDIM Ip SNC

essence series (stepDIM)

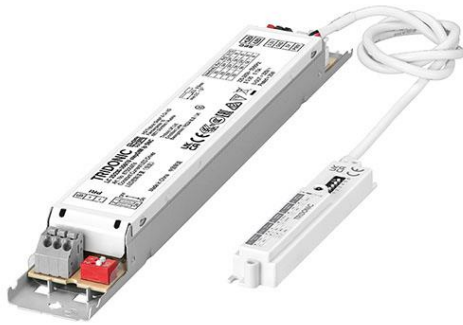

LED driver with sensor (included in delivery)

Product description

- _ LED Constant current LED driver for luminaire installation
- _ Motion and daylight detection (included in delivery)
- _ LED driver with sensor (included in delivery).
- _ For luminaires of protection class I and protection class II
- _ Temperature protection as per EN 61347-2-13 C5e
- _ Selectable fixed output current 350, 300, 250 and 200 mA (pre-selected current 350 mA)
- _ Max. output power 25 W
- _ Up to 84 % efficiency
- _ Nominal lifetime up to 100,000 h
- _ 5 years guarantee (Conditions at <https://www.tridonic.com/en/int/services/manufacture-guarantee-conditions>)

Housing properties

- _ Casing driver: metal, white
- _ Casing sensor: polycarbonate, white
- _ Type of protection IP20

Functions

- _ Overload protection
- _ Short-circuit protection
- _ No-load protection

Website

<http://www.tridonic.com/87500974>

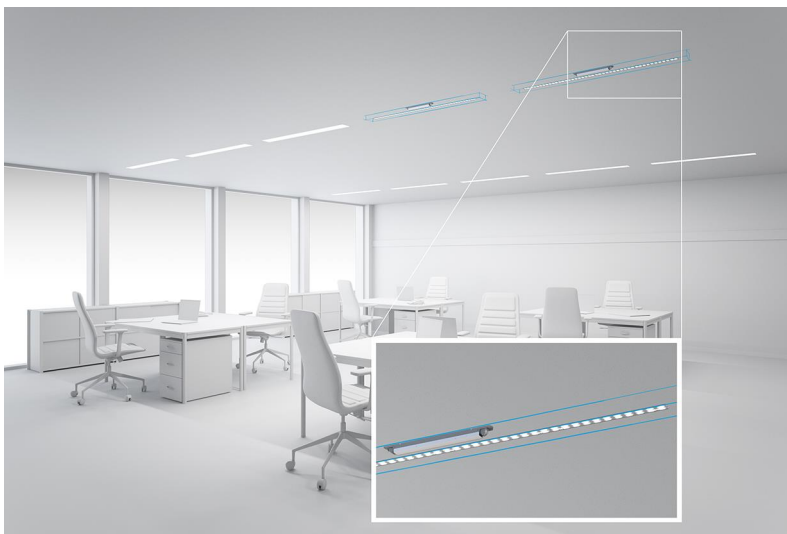

Linear



High bay



Decorative



Downlights



Spotlights



Free-standing



Area



Floor | Wall



Street

Driver LC 25W 200-350mA stepDIM Ip SNC

essence series (stepDIM)

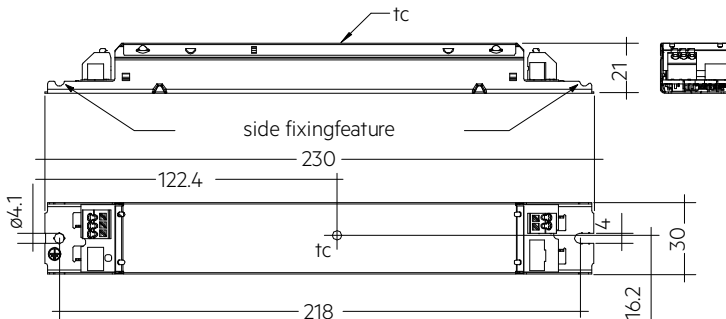

Ordering data

Type	Article number	Packaging, carton	Packaging, pallet	Weight per pc.
LC 25/200-350/70 stepDIM Ip SNC	87500974	20 pc(s).	420 pc(s).	0.155 kg

Technical data

Rated supply voltage	220 – 240 V
AC voltage range	198 – 264 V
Max. input current (at 230 V, 50 Hz, full load)	0.13 A
Leakage current (at 230 V, 50 Hz, full load)	< 450 μ A
Mains frequency	50 / 60 Hz
Overvoltage protection	320 V AC, 1 h
Max. output power	25 W
Output power range	5 – 24.5 W
Typ. efficiency (at 230 V, 50 Hz, full load) ^①	84 %
λ (at 230 V, 50 Hz, full load) ^①	0.95
Output current tolerance ^②	\pm 7.5 %
Max. output voltage (U-OUT)	320 V
THD (at 230 V, 50 Hz, full load) ^①	< 15 %
Max. peak output current at full load ^①	390 mA
Output LF current ripple (< 120 Hz) at full load	\pm 3 %
Output P_ST_LM (at full load)	\leq 1
Output SVM (at full load)	\leq 0.4
Starting time (at 230 V, 50 Hz, full load)	\leq 0.5 s
Turn off time (at 230 V, 50 Hz, full load)	\leq 0.5 s
Hold on time at power failure (output)	0 s
Ambient temperature t_a (at lifetime 50,000 h)	60 °C
Storage temperature t_s	-40 ... +80 °C
Mains burst capability	1 kV
Mains surge capability (between L - N)	1 kV
Mains surge capability (between L/N - PE)	2 kV
Surge voltage at output side (against PE)	4 kV
Lifetime	up to 100,000 h
Guarantee (conditions at www.tridonic.com)	5 Year(s)
Dimensions L x W x H	230 x 30 x 21 mm
Hole spacing D	218 mm

Approval marks



Standards

EN 55015, EN 61000-3-2, EN 61000-3-3, EN 61347-1, EN 61347-2-13, EN 61547, EN 62384, EN 60598-1

Specific technical data

Type	Output current ^①	Min. output voltage	Max. output voltage	Max. output power	Typ. power consumption (at 230 V, 50 Hz, full load)	Typ. current consumption (at 230 V, 50 Hz, full load)	tc point max.	Ambient temperature ta	I-out select
LC 25/200-350/70 stepDIM Ip SNC	200 mA	25 V	70 V	14.0 W	16.5 W	85 mA	80 °C	-20 ... +60 °C	1=off / 2=off
LC 25/200-350/70 stepDIM Ip SNC	250 mA	25 V	70 V	17.5 W	20.5 W	100 mA	80 °C	-20 ... +60 °C	1=off / 2=on
LC 25/200-350/70 stepDIM Ip SNC	300 mA	25 V	70 V	21.0 W	24.5 W	115 mA	80 °C	-20 ... +60 °C	1=on / 2=off
LC 25/200-350/70 stepDIM Ip SNC	350 mA	25 V	70 V	24.5 W	28.5 W	130 mA	80 °C	-20 ... +60 °C	1=on / 2=on

① Test result at 350 mA.

② Test result at 25 °C.

③ Output current is mean value.

Driver LC 25W 200-350mA stepDIM Ip SNC4

Product description

1. Standards

EN 55015
 EN 61000-3-2
 EN 61000-3-3
 EN 61347-1
 EN 61347-2-13
 EN 61547
 EN 62384
 EN 60598-1

2. Thermal details and lifetime

2.1 Expected lifetime

Type	ta	50 °C	65 °C
LC 25/200-350/70 stepDIM Ip SNC	tc	70 °C	80 °C
	Lifetime	100,000 h	37,000 h

The LED driver is designed for a lifetime stated above under reference conditions and with a failure probability of less than 10 %.

The relation of tc to ta temperature depends also on the luminaire design. If the measured tc temperature is approx. 5 K below tc max., ta temperature should be checked and eventually critical components (e.g. ELCAP) measured. Detailed information on request.

3. Installation / wiring

3.1 Circuit diagram

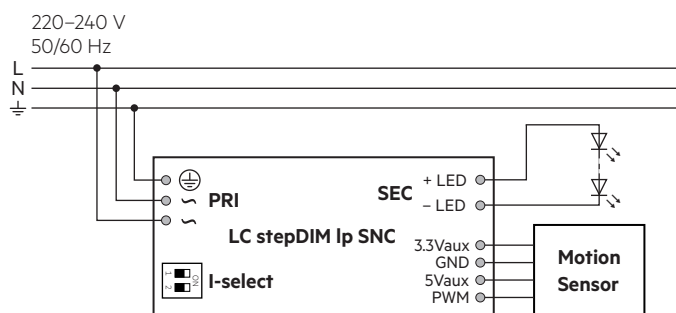

3.2 Wiring type and cross section

For wiring use stranded wire with ferrules or solid wire from 0.5 – 1.5 mm². Strip 8.5 – 9.5 mm of insulation from the cables to ensure perfect operation of the push-wire terminals (WAGO 250).

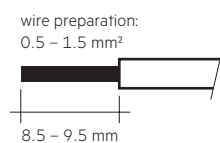

3.3 Release of the wiring

Press down the “push button” and remove the cable from front.

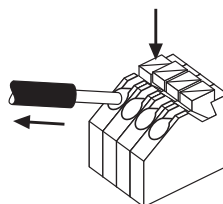

3.4 Wiring guidelines

- All connections must be kept as short as possible to ensure good EMI behaviour.
- Mains leads should be kept apart from LED driver and other leads (ideally 5 – 10 cm distance)
- Max. length of output wires is 2 m.
- Incorrect wiring can damage LED modules.
- To avoid damage of the Driver, the wiring must be protected against short circuits to earth (sharp edged metal parts, metal cable clips, louver, etc.).

3.5 Earth connection

The earth connection is conducted as protection earth (PE). The LED driver can be earthed via metal housing. If the LED driver will be earthed, protection earth (PE) has to be used. There is no earth connection required for the functionality of the LED driver. Earth connection is recommended to improve following behaviour.

- Electromagnetic interferences (EMI)
- Transmission of mains transients to the LED output

In general it is recommended to earth the LED driver if the LED module is mounted on earthed luminaire parts respectively heat sinks and thereby representing a high capacity against earth.

For Class II application, protection earth is no need to be connected, below 2 scenarios should be considered:

- If the LED driver housing is screw on a metal part inside the luminaires, both LED driver and LED module must be insulated.
- If the LED driver housing is screw on a plastic part inside the luminaires, the LED module need to be insulated.

3.6 Replace LED module

1. Mains off
2. Remove LED module
3. Wait for 30 seconds
4. Connect LED module again

Hot plug-in or output switching of LEDs is not permitted and may cause a very high current to the LEDs.

3.7 Mounting of device

Max. torque for fixing: 0.5 Nm/M4

3.8 Current setting

200 mA: Switch 1 = Off, Switch 2 = Off

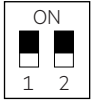

250 mA: Switch 1 = Off, Switch 2 = On

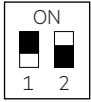

300 mA: Switch 1 = On, Switch 2 = Off



350 mA: Switch 1 = On, Switch 2 = On

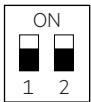

Set the current by DIP switch after mains off.
Use of DIP switch only after mains off.

4. Electrical values

4.1 Efficiency vs load

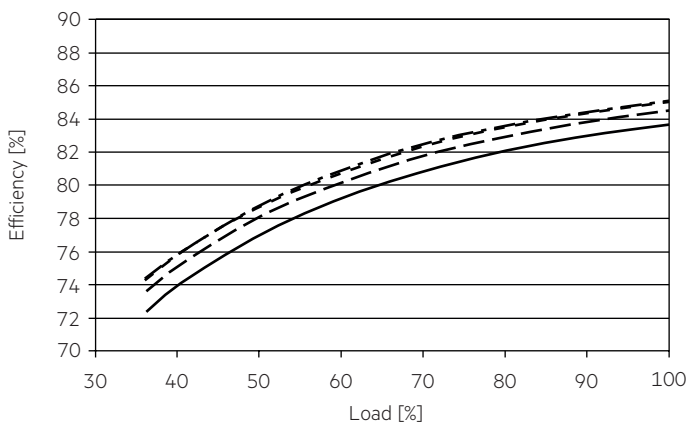

4.2 Power factor vs load

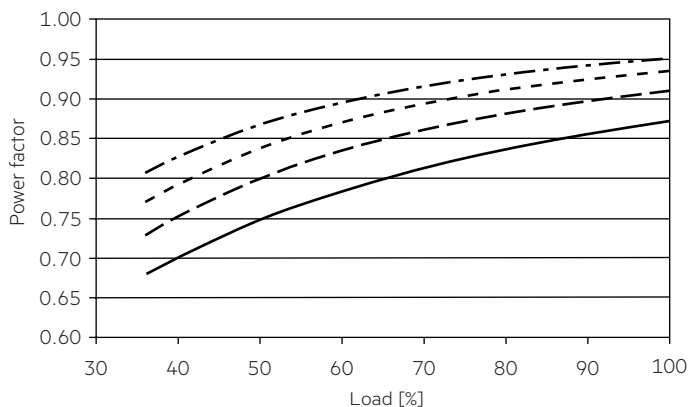

4.3 Input power vs load

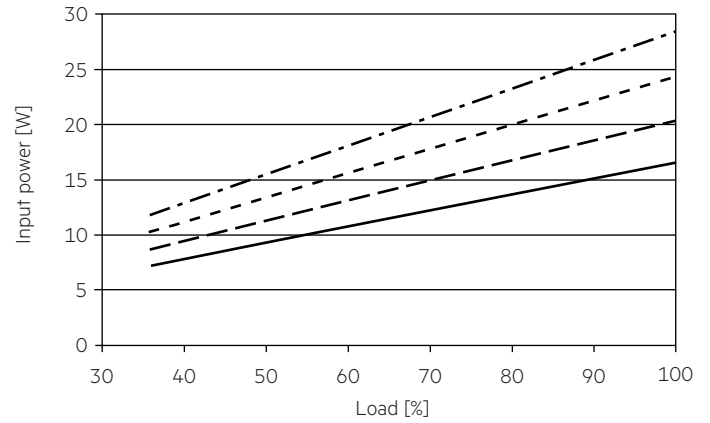

4.4 Input current vs load

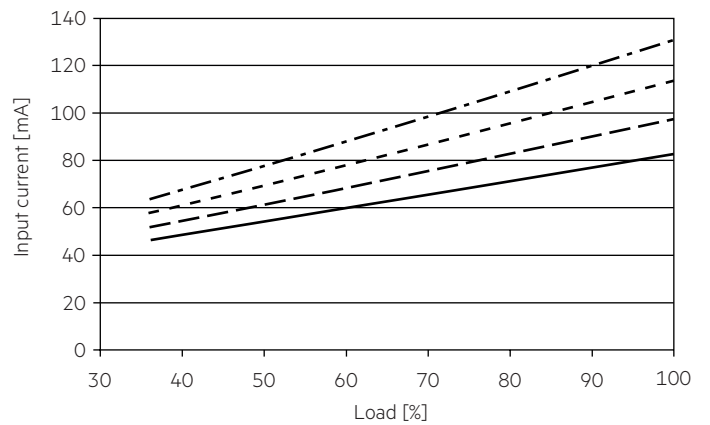

4.5 THD vs load (without harmonic < 5 mA or 0.6 % of the input current)

THD without harmonic < 5 mA (0.6 %) of the input current:

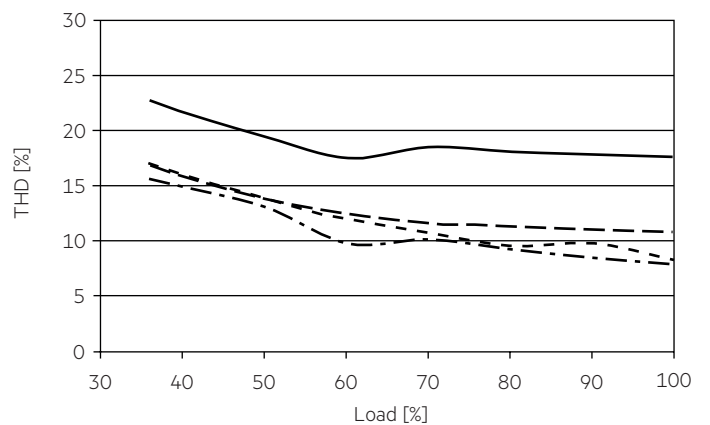

- 200 mA
- - - 250 mA
- · - · 300 mA
- · - · - · 350 mA

4.6 Maximum loading of automatic circuit breakers

Automatic circuit breaker type	C10	C13	C16	C20	B10	B13	B16	B20	Inrush current	
Installation Ø	1.5 mm ²	1.5 mm ²	1.5 mm ²	2.5 mm ²	1.5 mm ²	1.5 mm ²	1.5 mm ²	2.5 mm ²	I _{max}	Time
LC 25/200-350/70 stepDIM Ip SNC	50	65	80	100	50	65	80	100	10 A	80 µs

These are max. values calculated out of continuous current running the device on full load. There is no limitation due to in-rush current. If load is smaller than full load for calculation only continuous current has to be considered.

4.7 Harmonic distortion in the mains supply (at 230 V / 50 Hz and full load) in %

	THD	3.	5.	7.	9.	11.
LC 25/200-350/70 stepDIM Ip SNC	< 15	< 10	< 7	< 7	< 5	< 3

Acc. to 61000-3-2. Harmonics < 5 mA or < 0.6 % (whatever is greater) of the input current are not considered for calculation of THD.

5. Functions

5.1 Short-circuit behaviour

In case of a short circuit on the output side (LED) the LED driver switches off. After elimination of the short-circuit fault the LED driver will recover automatically.

5.2 No-load operation

The LED driver works in burst working mode to provide a constant output voltage regulation which allows the application to be able to work safely when LED string opens due to a failure.

5.3 Overload protection

If the maximum load is exceeded by a defined internal limit, the LED driver will protect itself and LED may flicker. After elimination of the overload, the nominal operation is restored automatically.

6. Miscellaneous

6.1 Insulation and electric strength testing of luminaires

Electronic devices can be damaged by high voltage. This has to be considered during the routine testing of the luminaires in production.

According to IEC 60598-1 Annex Q (informative only!) or ENEC 303-Annex A, each luminaire should be submitted to an insulation test with 500 V_{DC} for 1 second. This test voltage should be connected between the interconnected phase and neutral terminals and the earth terminal.

The insulation resistance must be at least 2 MΩ.

As an alternative, IEC 60598-1 Annex Q describes a test of the electrical strength with 1500 V_{AC} (or 1.414 x 1500 V_{DC}). To avoid damage to the electronic devices this test must not be conducted.

6.2 Conditions of use and storage

Humidity: 5 % up to max. 85 %, not condensed (max. 56 days/year at 85 %)

Storage temperature: -40 °C up to max. +80 °C

The devices have to be within the specified temperature range (t_a) before they can be operated.

The LED driver is declared as inbuilt LED controlgear, meaning it is intended to be used within a luminaire enclosure.

If the product is used outside a luminaire, the installation must provide suitable protection for people and environment (e.g. in illuminated ceilings).

6.3 Additional information

Additional technical information at www.tridonic.com → Technical Data

Lifetime declarations are informative and represent no warranty claim. No warranty if device was opened.



Motion Sensor (included)

Automatic switching based on motion and light level

Technical data

Output signal	0 – 5 V (PWM 3 kHz)
Power	< 0.25 W
Frequency	5.8 GHz (± 75 MHz)
Transmission power	< 1 mW
Detection angle	150°
t _c	70 °C
Ambient temperature t _a	-20 ... +70 °C
Storage temperature t _s	-20 ... +70 °C
Humidity	min. 5 % ... max. 95 %
Type of protection	IP20
Protection class	Protection class II
Casing material	PC, halogen-free
Casing colour	White
Dimensions L x W x H	89 x 15.8 x 12.1 mm
Hole spacing D	84 mm

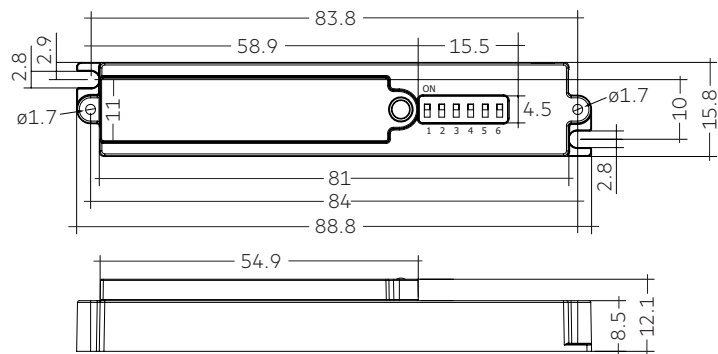
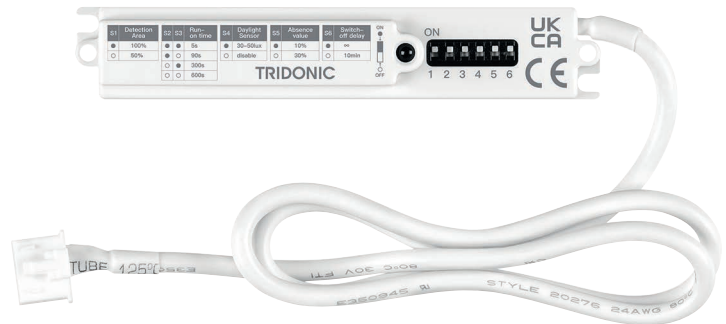

1. Standards

IEC 61347-1
IEC 61347-2-11
EN 61347-1
EN 61347-2-11

1.1 Glow wire test

according to EN 60598-1 with increased temperature of 850 °C passed.

2. Description

- High frequency motion and light sensor for luminaire installation.
- Motion detection through glass and thin materials (except metal).
- Bright-out function - LED driver is not switched on if there is adequate brightness.
- Maximum installation height 5 m.
- Adjustable settings via dip switches.

3. Installation



- Avoid installing metal accessories or shells, metal will block the signal transmission and affect the effect.
- The antenna surface should avoid large current circuit coverage, which may cause interference.
- The photosensitive position should avoid being blocked by opaque objects, which will change the light intensity.
- The recommended installation distance of the sensor is greater than 1.5 m.

3.1 Circuit diagram

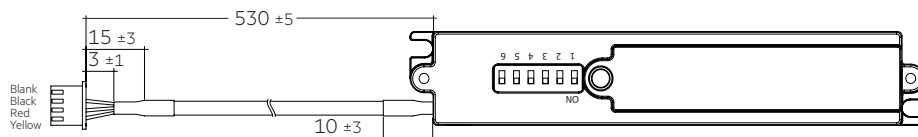

Cable: White UL 2547 3x28AWG black-red-yellow

Heat tube: $\varnothing 3.0$ UL L = 20 mm

Connector: XH2.5-T 4P white shell with buckle

3.2 Ceiling installation

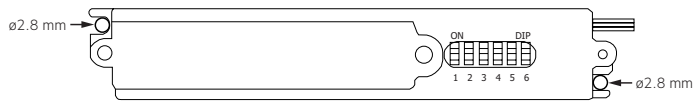

3.3 Embedded installation

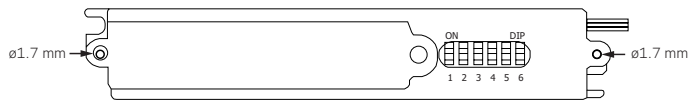

When the motion sensor is embedded in the lamp board or aluminum substrate, the metal is close to the RF hollow width of the lamp board or aluminum substrate is required as follows:

1. When the thickness of the baffle plate and the aluminum substrate (all the metal part) is $D < 1$ mm, the suggested hollow length is 80 mm, width > 13 mm.

lamp board:

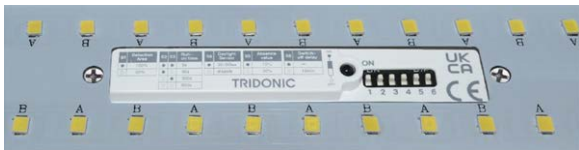

aluminum substrate:

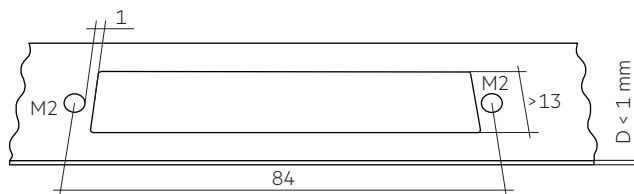

2. When the thickness of the baffle plate and the aluminum substrate (all the metal part) is $1 \text{ mm} < D < 2$ mm, the suggested hollow length is 80 mm, width > 15 mm.

lamp board:



aluminum substrate:

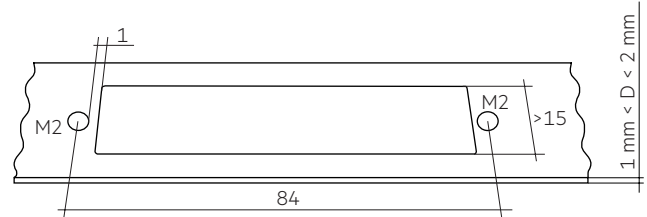

3. When the thickness of the lamp block plate and the aluminum substrate (all the metal part) is $D > 2$ mm, the suggested hollow length is 80 mm, width > 18 mm.

lamp board:



aluminum substrate:

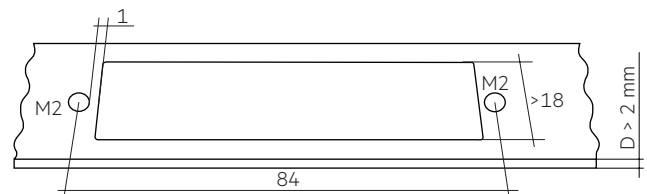

4. Functions

4.1 Process diagram when power on

By default all DIP switches on the sensor are ON.

After the Output signal changes from 100 % to 10 % or 30 % (with a fade time of 1 s), the sensor is locked for approximately 3 s.

During this period, the motion detection is deactivated.

15s after initially turning on, the light will be turned OFF, if daylight is detected. After that the light levels are checked continuously and depending on the light level, the sensor reacts as follows:

- The light levels are high → daytime mode is activated (this takes 10 min above a certain lux-level) and presence detection is off.
- The light levels are low → nighttime mode is activated (this takes 5 s).

If sensor DIP switch 6 is OFF (the Output signal is 10 % or 30 % PWM), the luminaire will turn OFF after 10 min of absence.

4.2 Adjustable dip switch setting

Setting the detection area (1. dip switch)

1	Sensitivity
●	100 % (default)
○	50 %

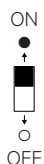

Setting the standby dimming (5. dip switch)

5	Standby dimming
●	10 % (default)
○	30 %



Setting the hold time (2. and 3. dip switch)

2	3	Hold time
●	●	5 s (default)
●	○	90 s
○	●	300 s
○	○	600 s

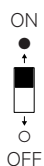

Setting the second-order delay (6. dip switch)

6	Second-order delay
●	∞ (default)
○	10 min



Setting the daylight sensor (4. dip switch)

4	Daylight sensor
●	30 lux (default)
○	disable

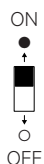

Dip switch factory settings all default ON state.

Set the dip switch only after mains off.

Hot plug-in is not permitted when connecting sensors.

4.3 Motion detection

Ceiling mounted:

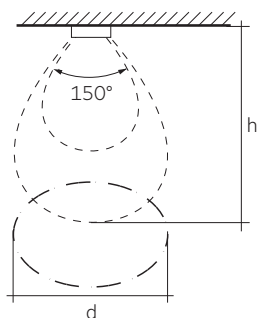

Wall mounted:

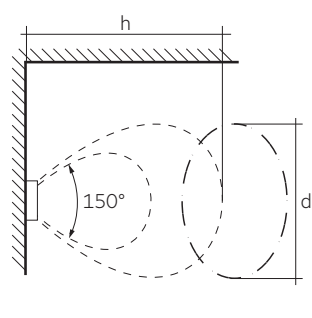

Take 3 m as an example, the detected moving target person is: approx. 165 cm high and weighing approx. 65 kg.

A person moved towards the sensor with a speed of 1 m/s during the test in the test room. The sensing range at different heights is as follows:

Mounting height (h)	Detection diameter at 1 m/s moving speed (d)	
	100 % sensitivity	50 % sensitivity
0.5 m	4.5 m	2.0 m
1.0 m	5.0 m	2.5 m
1.5 m	5.0 m	2.5 m
2.0 m	5.0 m	2.5 m
2.5 m	5.5 m	3.0 m
3.0 m	6.0 m	3.0 m
3.5 m	5.5 m	3.0 m
4.0 m	5.0 m	2.0 m
4.5 m	5.0 m	2.0 m
5.0 m	4.0 m	2.0 m
5.5 m	3.0 m	1.0 m
6.0 m	2.0 m	1.0 m

Influence factors of detection distance:

- It is related to the speed of the object.
- It is related to the size of the object (the area of reception and reflection).
- In the open environment and the environment with walls, the distance difference is related to the reflection of electromagnetic waves in the face of walls.
- Background noise auto-learning capability:
Within 15 s after the initial power-on, the software algorithm will dynamically recognize environmental background noise (unintentional regular small movements or emissions) and auto-learn to ignore it. This includes but isn't limited to fans as well as motor and electromagnetic emissions of the control gear inside the luminaire, so that it can adapt well to different installation environments and avoid potential false trigger issues on site.
- The 5 s run-on time is mainly used for the fast test mode to verify whether the stepDIM sensor is working properly or not. After the motion has been triggered for the first time, dimming may occur even if continuous motion has been detected.

4.4 Detection sensibility

Optimized for detection of pedestrians with a speed of 0.5 – 1.5 m/s corresponds to 1.8 – 5.4 km/h.

Depending on the application and environmental conditions the maximum detectable speed of object may vary.

5. Application examples

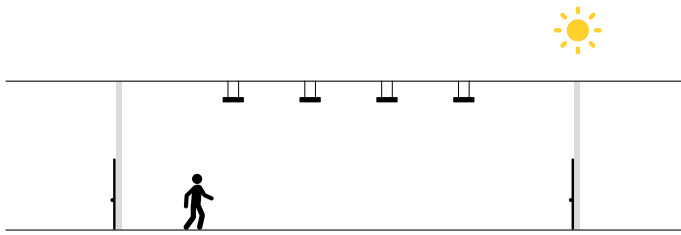

While in daylight mode, the sensor does not activate light when movement is detected.

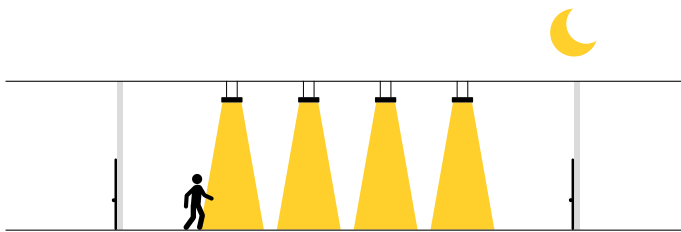

While in night mode, the sensor activates light when movement is detected.

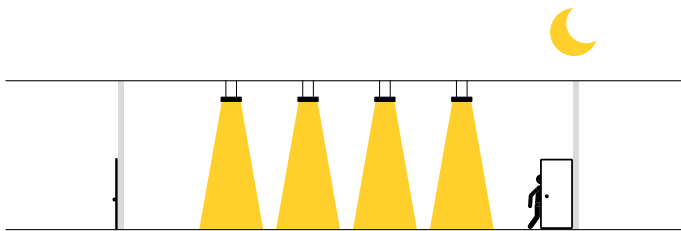

If the moving object leaves the detection area or keeps still, the light will keep on for the duration of the delay time.

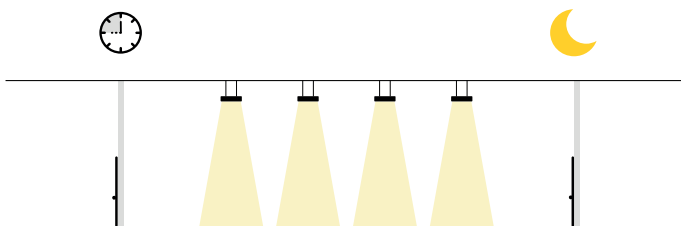

After the preset delay time, the light will enter a dimmed state (at 10 or 30 %).

6. Miscellaneous

6.1 Disposal of equipment



Return old devices in accordance with the WEEE directive to suitable recycling facilities.

6.2 Additional information

Additional technical information at www.tridonic.com → Technical Data

Lifetime declarations are informative and represent no warranty claim. No warranty if device was opened.