

Driver LC 100W 300-1050mA DA Ip SNC4

essence series

**Product description**

- _ Dimmable built-in constant current LED driver
- _ For luminaires of protection class I and protection class II
- _ Temperature protection as per EN 61347-2-13 C5e
- _ Adjustable output current via dip switch or DALI
- _ Selectable fixed output current 300, 350, 400, 450, 500, 550, 600, 650, 700, 750, 800, 850, 900, 950, 1000 and 1050 mA (pre-selected current 300 mA)
- _ Max. output power 100 W
- _ Up to 93 % efficiency
- _ Anti-glowing design
- _ Nominal lifetime of 100,000 h
- _ 5 years guarantee (conditions at <https://www.tridonic.com/en/int/services/manufacturer-guarantee-conditions>)

Housing properties

- _ Low profile metal casing with white cover
- _ Type of protection IP20

Interfaces

- _ one4all (DALI-2, switchDIM, corridorFUNCTION)
- _ Terminal blocks: 0° push terminals

Functions

- _ Adjustable output current in 1-mA-steps (DALI)
- _ Constant light output function (CLO)
- _ Protective features (overtemperature, short-circuit, overload, no-load)
- _ Suitable for emergency escape lighting systems acc. to EN 50172

Benefits

- _ Flexible configuration via companionSUITE (DALI)
- _ Application-oriented operating window for maximum compatibility
- _ Best energy savings due to low stand-by losses and high efficiency

Typical applications

- _ For linear/area lighting

Website

<http://www.tridonic.com/87501207>



Linear



High bay



Decorative



Downlights



Spotlights



Free-standing



Area



Floor | Wall



Street

Driver LC 100W 300-1050mA DA Ip SNC4

essence series

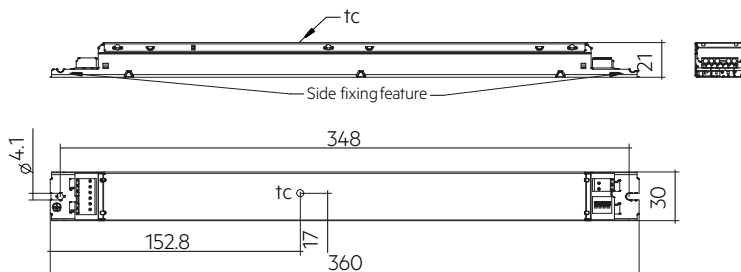

Ordering data

Type	Article number	Packaging, carton	Packaging, pallet	Weight per pc.
LC 100/300-1050/230 DA Ip SNC4	87501207	50 pc(s).	600 pc(s).	0.247 kg

Technical data

Rated supply voltage	220 – 240 V
AC voltage range	198 – 264 V
DC voltage range	176 – 280 V
Mains frequency	0 / 50 / 60 Hz
Overvoltage protection	320 V AC, 48 h
Typ. rated current (at 230 V, 50 Hz, full load) ^{①②}	475 mA
Typ. current (220 V, 0 Hz, full load, EOFx dimlevel) ^②	71 mA
Leakage current (at 230 V, 50 Hz, full load) ^{①②}	< 500 µA
Max. input power	108 W
Output power range (P _{rated})	17.3 – 100 W
Typ. efficiency (at 230 V, 50 Hz, full load) ^②	93 %
λ over full operating range (max.) ^①	0.98
λ over full operating range (min.)	0.66C
Typ. power consumption on stand-by ^{③④}	< 0.45 W
In-rush current (peak / duration)	32 A / 209 µs
THD (at 230 V, 50 Hz, full load) ^①	< 10 %
Starting time (AC mode)	< 700 ms
Starting time (DC mode)	< 700 ms
Switchover time (AC/DC) ^⑤	< 300 ms
Turn off time (at 230 V, 50 Hz, full load)	< 30 ms
Output current tolerance ^{⑥①}	± 5 %
Max. output current peak (non-repetitive)	± output current + 20 %
Output LF current ripple (< 120 Hz)	< 5 %
Output P _{ST_LM} (at full load)	≤ 1
Output SVM (at full load)	≤ 0.4
Max. output voltage (U-OUT)	250 V
Dimming range	1 – 100 % (min. 5 mA)
Mains surge capability (between L - N) ^⑦	1 kV
Mains surge capability (between L/N - PE)	2 kV
Burst / surge peaks output side against PE	< 3 kV
Type of protection	IP20
Lifetime	up to 100,000 h
Guarantee (conditions at www.tridonic.com)	5 Year(s)
Dimensions L x W x H	360 x 30 x 21 mm

Approval marks



Standards

EN 55015, EN 61000-3-2, EN 61000-3-3, EN 61347-1, EN 61347-2-13, EN 62384, EN 61547, EN 62386-101, EN 62386-102, EN 62386-207 (DALI-2), EN 61000-4-4, EN 61000-4-5, according to EN 50172

Specific technical data

Type	Output current ^⑥	Min. output voltage	Max. output voltage	Max. output power	Typ. power consumption (at 230 V, 50 Hz, full load)	Typ. current consumption (at 230 V, 50 Hz, full load)	t _c point max.	Ambient temperature t _a	I-out select
LC 100/300-1050/230 DA Ip SNC4	300 mA	57.5 V	230.0 V	69 W	73.40 W	331.94 mA	85 °C	-20 ... +70 °C	1=off / 2=off / 3=off / 4=off
LC 100/300-1050/230 DA Ip SNC4	350 mA	57.5 V	230.0 V	81 W	85.30 W	382.40 mA	85 °C	-20 ... +70 °C	1=off / 2=off / 3=off / 4=on
LC 100/300-1050/230 DA Ip SNC4	400 mA	57.5 V	230.0 V	92 W	97.30 W	432.80 mA	85 °C	-20 ... +65 °C	1=off / 2=off / 3=on / 4=off
LC 100/300-1050/230 DA Ip SNC4	450 mA	57.5 V	222.0 V	100 W	105.40 W	466.50 mA	85 °C	-20 ... +65 °C	1=off / 2=off / 3=on / 4=on
LC 100/300-1050/230 DA Ip SNC4	500 mA	57.5 V	200.0 V	100 W	105.40 W	471.60 mA	85 °C	-20 ... +65 °C	1=off / 2=on / 3=off / 4=off
LC 100/300-1050/230 DA Ip SNC4	550 mA	57.5 V	182.0 V	100 W	106.14 W	471.60 mA	85 °C	-20 ... +65 °C	1=off / 2=on / 3=off / 4=on
LC 100/300-1050/230 DA Ip SNC4	600 mA	57.5 V	167.0 V	100 W	106.40 W	472.80 mA	85 °C	-20 ... +60 °C	1=off / 2=on / 3=on / 4=off
LC 100/300-1050/230 DA Ip SNC4	650 mA	57.5 V	154.0 V	100 W	108.34 W	480.80 mA	85 °C	-20 ... +60 °C	1=off / 2=on / 3=on / 4=on
LC 100/300-1050/230 DA Ip SNC4	700 mA	57.5 V	143.0 V	100 W	108.44 W	481.20 mA	85 °C	-20 ... +60 °C	1=on / 2=off / 3=off / 4=off
LC 100/300-1050/230 DA Ip SNC4	750 mA	57.5 V	133.0 V	100 W	108.49 W	481.40 mA	85 °C	-20 ... +60 °C	1=on / 2=off / 3=off / 4=on
LC 100/300-1050/230 DA Ip SNC4	800 mA	57.5 V	125.0 V	100 W	107.13 W	475.80 mA	85 °C	-20 ... +60 °C	1=on / 2=off / 3=on / 4=off
LC 100/300-1050/230 DA Ip SNC4	850 mA	57.5 V	117.5 V	100 W	107.11 W	475.40 mA	85 °C	-20 ... +60 °C	1=on / 2=off / 3=on / 4=on
LC 100/300-1050/230 DA Ip SNC4	900 mA	57.5 V	111.0 V	100 W	107.20 W	476.10 mA	85 °C	-20 ... +60 °C	1=on / 2=on / 3=off / 4=off
LC 100/300-1050/230 DA Ip SNC4	950 mA	57.5 V	105.0 V	100 W	107.31 W	474.80 mA	85 °C	-20 ... +60 °C	1=on / 2=on / 3=off / 4=on
LC 100/300-1050/230 DA Ip SNC4	1,000 mA	57.5 V	100.0 V	100 W	107.13 W	475.70 mA	85 °C	-20 ... +60 °C	1=on / 2=on / 3=on / 4=off
LC 100/300-1050/230 DA Ip SNC4	1,050 mA	57.5 V	95.0 V	100 W	107.43 W	475.10 mA	85 °C	-20 ... +60 °C	1=on / 2=on / 3=on / 4=on

① Valid at 100 % dimming level.

② Depending on the selected output current.

③ Valid for immediate change of power supply type otherwise the starting time is valid. For light output level in DC operation >10 %.

④ Depending on the DALI traffic at the interface.

⑤ Valid for immediate change of power supply type otherwise the starting time is valid.

⑥ Output current is mean value.

⑦ L-N acc. to EN 61000-4-5. 2 Ohm, 1.2/50 μs, 8/20 μs.

1. Standards

EN 55015
 EN 61000-3-2
 EN 61000-3-3
 EN 61000-4-4
 EN 61000-4-5
 EN 61347-1
 EN 61347-2-13
 EN 62384
 EN 61547
 EN 62386-101 (DALI-2)
 EN 62386-102 (DALI-2)
 EN 62386-207 (DALI-2)

According to EN 50172 for use in central battery systems

2. Thermal details and lifetime

2.1 Expected lifetime

Expected lifetime								
Type	Output current	ta	45 °C	50 °C	55 °C	60 °C	65 °C	70 °C
LC 100/300-1050/230 DA Ip SNC4	300 – 350 mA	tc	60 °C	65 °C	70 °C	75 °C	80 °C	85 °C
		Lifetime	>100,000 h	>100,000 h	>100,000 h	80,000 h	55,000 h	40,000 h
	> 400 – 450 mA	tc	60 °C	65 °C	70 °C	80 °C	85 °C	–
		Lifetime	>100,000 h	>100,000 h	>100,000 h	55,000 h	40,000 h	–
	> 450 – 550 mA	tc	65 °C	70 °C	75 °C	80 °C	85 °C	–
		Lifetime	>100,000 h	>100,000 h	80,000 h	55,000 h	40,000 h	–
	> 550 – 650 mA	tc	70 °C	75 °C	80 °C	85 °C	–	–
		Lifetime	>100,000 h	80,000 h	55,000 h	40,000 h	–	–
	> 650 – 750 mA	tc	70 °C	75 °C	80 °C	85 °C	–	–
		Lifetime	>100,000 h	80,000 h	55,000 h	40,000 h	–	–
	> 750 – 850 mA	tc	70 °C	75 °C	80 °C	85 °C	–	–
		Lifetime	>100,000 h	80,000 h	55,000 h	40,000 h	–	–
	> 850 – 1050 mA	tc	70 °C	75 °C	80 °C	85 °C	–	–
		Lifetime	>100,000 h	80,000 h	55,000 h	40,000 h	–	–

The LED driver is designed for a lifetime stated above under reference conditions and with a failure probability of less than 10 %.

The relation of tc to ta temperature depends also on the luminaire design.

If the measured tc temperature is approx. 5 K below tc max., ta temperature should be checked and eventually critical components (e.g. ELCAP) measured. Detailed information on request.

3. Installation / wiring

3.1 Circuit diagram

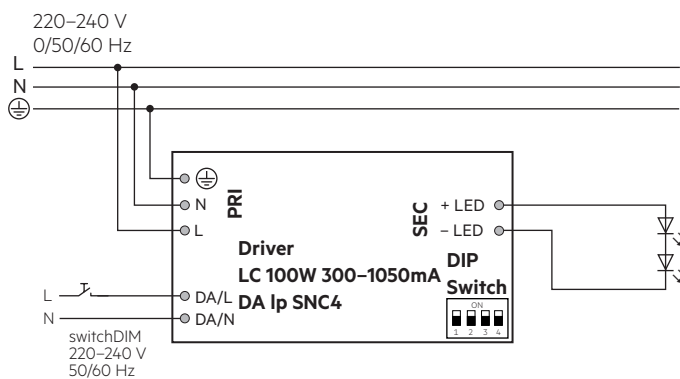
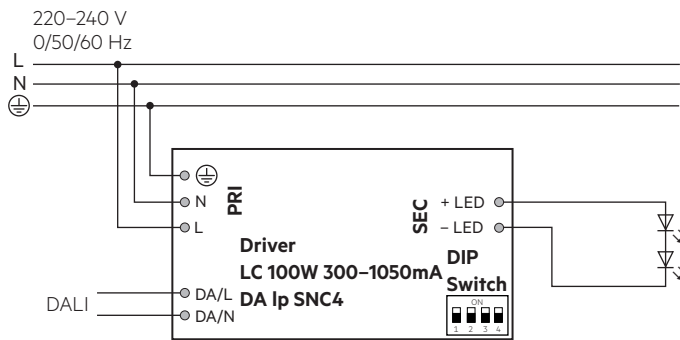

3.2 Wiring type and cross section

For wiring use solid wire from 0.5 – 1.5 mm².

Strip 8 – 9 mm of insulation from the cables to ensure perfect operation of terminals.

LED module/LED driver/supply

wire preparation:

0.5 – 1.5 mm²

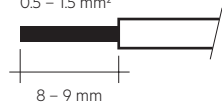

3.3 Loose wiring

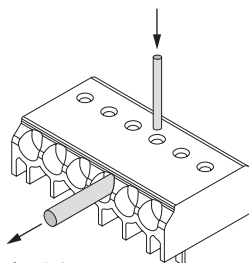

Loosen wire through twisting and pulling or using a Ø 1 mm release tool

3.4 Wiring guidelines

- The cables should be run separately from the mains connections and mains cables to ensure good EMC conditions.
- The LED wiring should be kept as short as possible to ensure good EMC. The max. secondary cable length is 2 m (4 m circuit), this applies for LED output.
- To comply with the EMC regulations run the secondary wires (LED module) in parallel.
- Secondary switching is not permitted.
- The LED driver has no inverse-polarity protection on the secondary side. Wrong polarity can damage LED modules with no inverse-polarity protection.
- Wrong wiring of the LED driver can lead to malfunction or irreparable damage.
- To avoid damage of the Driver, the wiring must be protected against short circuits to earth (sharp edged metal parts, metal cable clips, louver, etc.).

3.5 Earth connection

The earth connection is conducted as protection earth (PE).

If the LED Driver will be earthed, protection earth (PE) has to be used. Earth connection is recommended to improve following behaviour:

- Electromagnetic interferences (EMI)
- Transmission of mains transients to the LED output

In general it is recommended to earth the LED driver if the LED module is mounted on earthed luminaire parts respectively heat sinks and thereby representing a high capacity against earth.

3.6 Replace LED module

1. Mains off
2. Remove LED module
3. Wait for 30 seconds
4. Connect LED module again

Hot plug-in or secondary switching of LEDs is not permitted and may cause a very high current to the LEDs.

3.7 Installation note

Max. torque at the clamping screw: 0.5 Nm / M4

3.8 Current setting



Set the current by DIP switch after mains off.
Use of DIP switch only after mains off.

300 mA: Switch 1 = Off, Switch 2 = Off, Switch 3 = Off, Switch 4 = Off

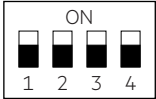

350 mA: Switch 1 = Off, Switch 2 = Off, Switch 3 = Off, Switch 4 = On

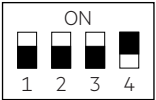

400 mA: Switch 1 = Off, Switch 2 = Off, Switch 3 = On, Switch 4 = Off

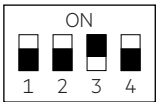

450 mA: Switch 1 = Off, Switch 2 = Off, Switch 3 = On, Switch 4 = On

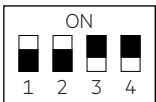

500 mA: Switch 1 = Off, Switch 2 = On, Switch 3 = Off, Switch 4 = Off

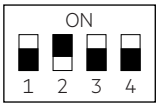

550 mA: Switch 1 = Off, Switch 2 = On, Switch 3 = Off, Switch 4 = On

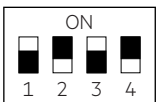

600 mA: Switch 1 = Off, Switch 2 = On, Switch 3 = On, Switch 4 = Off

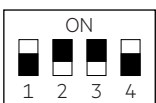

650 mA: Switch 1 = Off, Switch 2 = On, Switch 3 = On, Switch 4 = On

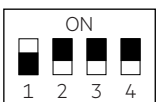

700 mA: Switch 1 = On, Switch 2 = Off, Switch 3 = Off, Switch 4 = Off

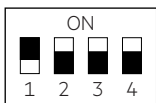

750 mA: Switch 1 = On, Switch 2 = Off, Switch 3 = Off, Switch 4 = On

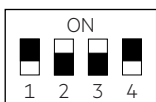

800 mA: Switch 1 = On, Switch 2 = Off, Switch 3 = On, Switch 4 = Off

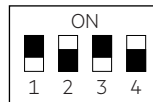

850 mA: Switch 1 = On, Switch 2 = Off, Switch 3 = On, Switch 4 = On



900 mA: Switch 1 = On, Switch 2 = On, Switch 3 = Off, Switch 4 = Off

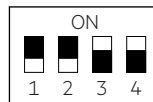

950 mA: Switch 1 = On, Switch 2 = On, Switch 3 = Off, Switch 4 = On

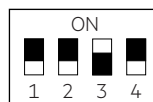

1000 mA: Switch 1 = On, Switch 2 = On, Switch 3 = On, Switch 4 = Off

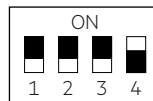

1050 mA: Switch 1 = On, Switch 2 = On, Switch 3 = On, Switch 4 = On

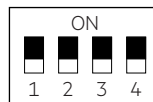

4. Electrical values

4.1 Operating window

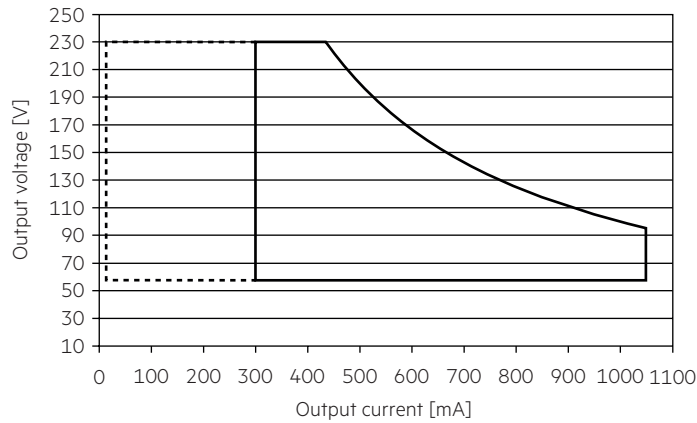

- Operating window 100 %
- - - - - Operating window dimmed

Make sure that the LED driver is operated within the given window under all operating conditions. Special attention needs to be paid at dimming and DC emergency operation as the forward voltage of the connected LED modules varies with the dimming level, due to the implemented amplitude dimming technology. Coming below the specified minimum output voltage of the LED driver may cause the device to shut-down. See chapter “6.11 Light level in DC operation” for more information.

4.2 Efficiency vs load

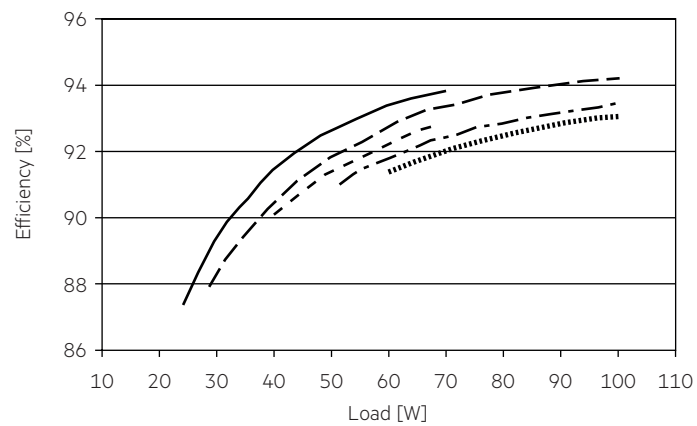

- 300 mA
- - - 500 mA
- · - · - 700 mA
- - - - - 900 mA
- 1050 mA

4.3 Power factor vs load

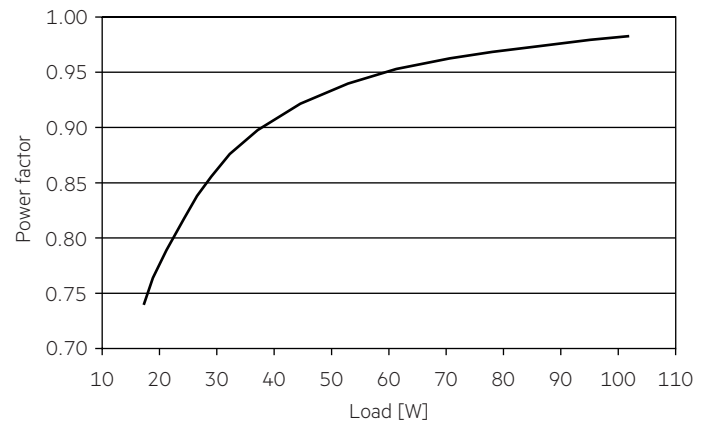

4.4 THD vs load

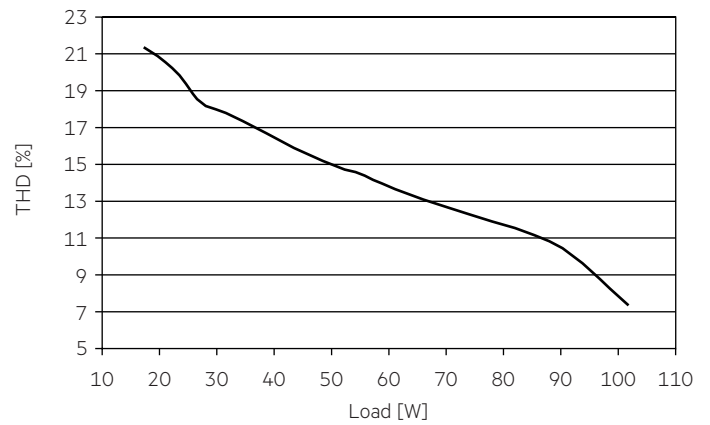

100 % load corresponds to the max. output power (full load) according to the table on page 3.

4.5 Maximum loading of automatic circuit breakers in relation to inrush current

Automatic circuit breaker type	C10	C13	C16	C20	B10	B13	B16	B20	Inrush current	
									I_{max}	time
Installation \varnothing	1.5 mm ²	1.5 mm ²	2.5 mm ²	4 mm ²	1.5 mm ²	1.5 mm ²	2.5 mm ²	4 mm ²	32 A	209 μ s
LC 100/300-1050/230 DA Ip SNC4	18	23	30	37	11	14	18	22		

These are max. values calculated out of inrush current! Please consider not to exceed the maximum rated continuous current of the circuit breaker.

Calculation uses typical values from ABB series S200 as a reference.

Actual values may differ due to used circuit breaker types and installation environment.

4.6 Harmonic distortion in the mains supply (at 230 V / 50 Hz and full load) in %

	THD	3.					7.		9.		11.	
		< 9	< 7	< 7	< 3	< 3	< 3	< 3	< 3	< 3	< 3	
LC 100/300-1050/230 DA Ip SNC4												

5. Software / Programming / Interfaces

5.1 Software / programming

With appropriate software and interface different functions can be activated and various parameters can be configured in the LED driver. The Driver supports the following software and interfaces:

Software / hardware for configuration:

- companionSUITE (deviceGENERATOR, deviceCONFIGURATOR, deviceANALYSER)
- masterCONFIGURATOR

Interfaces for data transfer:

- Control input DALI
- Control input switchDIM

5.2 Control input DALI

The control input is non-polar for digital control signals (DALI). The control signal is not SELV. The control cable has to be installed in accordance to the requirements of low voltage installations.

Digital control with:

- DALI signal: 16 bit

Dimming is realized by amplitude dimming.

5.3 Control Input switchDIM

A standard pushbutton (switchDIM) can be wired on the terminals (DA/N and DA/L).

Integrated switchDIM function allows a direct connection of a pushbutton for dimming and switching.

Brief push (< 0.6 s) switches LED driver ON and OFF. The dimm level is saved at power-down and restored at power-up.

When the pushbutton is held, LED modules are dimmed. After repush the LED modules are dimmed in the opposite direction.

In installations with LED drivers with different dimming levels or opposite dimming directions (e.g. after a system extension), all LED drivers can be synchronized to 50 % dimming level by a 10 s push.

Use of pushbutton with indicator lamp is not permitted.

















6. Functions

◇ masterCONFIGURATOR:

DALI-USB

The masterCONFIGURATOR is available via our WEB page:

<https://www.tridonic.com/com/en/software-masterconfigurator.asp>

Icon	Function	DALI-2
	OEM Identification	◇
	OEM GTIN	◇
	Luminaire data	◇
	Label information	◇
	LED current	◇
	Device operating mode	◇
	Factory reset	◇
	switchDIM fading	◇
	corridorFUNCTION	◇
	Constant light output (CLO)	◇
	DC level	◇
	Enhanced power on level (ePOL)	◇
	DALI default parameters	◇
	Scenes and groups	◇
	Power-up fading	◇
	Dimming curve	◇

6.1 OEM Identification



The OEM (Original Equipment Manufacturer) can set his own identification number.

DALI Part 251: Memory bank 1 extension.

6.2 OEM GTIN



The Original Equipment Manufacturer (OEM) can set his own Global Trade Item Number (GTIN).

DALI Part 251: Memory bank 1 extension.

6.3 Luminaire data



This function provides the asset management with accurate data about the luminaire.

DALI Part 251: Memory bank 1 extension.

6.4 Label information



In production, an individual label can be printed out for each device.

For this there are different default values (Batch No., Production Date, ...) available.

In addition, you can use these two text input fields to insert your own luminaire information and print it out.

6.5 LED current



The LED output current must be adapted to the connected LED module. The value is limited by the current range of the respective device.

6.6 Device operating mode



A Tridonic driver supports several control signals.

These control signals are automatically detected and the mode is adapted.

If only one special device mode is required, this mode can be fixed here.

“Automatic detection” is the default setting.

6.7 Factory reset



This device supports the function to reset all parameters back to factory defaults.

6.8 switchDIM fading



Here you can set the fade time of the control gear when using switchDIM.

6.9 corridorFUNCTION



A motion detector (corridorFUNCTION) can be wired on the terminals (DA/N and DA/L).

With the corridorFUNCTION and a commercially available motion detector, it is easy to adapt the lighting in one area to its use.

That is, when the area is entered by a person, the lighting dims instantly to a certain brightness and is available in desired strength.

After the area is left by the person, the brightness dims slowly to a smaller value or switches off completely.

The individual parameters of the desired profile, such as brightness values or delay times, can be adjusted flexibly and individually.

To activate the corridorFUNCTION without using software a voltage of 230 V has to be applied at the DA/N and DA/L connection.

The unit will then switch automatically to the corridorFUNCTION.

corridorFUNCTION is a very simple tool for controlling gears with conventional pushbuttons or motion sensors.

To ensure correct operation a sinusoidal mains voltage with a frequency of 50 Hz or 60 Hz is required at the control input.

Special attention must be paid to achieving clear zero crossings.

Serious mains faults may impair the operation of corridorFUNCTION.

Note:

By using corridorFUNCTION programming and monitoring via DALI is always possible.

6.10 Constant Light Output (CLO)



With this function the light output of the LED module can be kept equal over the lifetime.

The light output of an LED module reduces over the course of its lifetime. The Constant Light Output (CLO) function compensates for this natural decline by constantly increasing the output current of the LED driver throughout its lifetime.

CLO shall be achieved by limitation of the LED current at the commissioning of the LED driver and providing a linear interpolation of the current over the time, depending on the data points given by the user.

6.11 Light level in DC operation



In emergency light systems with a central battery supply the DC recognition function uses the input voltage to detect if emergency mode is present.

The LED driver then automatically switches to DC mode and dims the light to the defined DC level.

Without DC recognition different and more complex solutions would have to be applied in order to detect emergency mode.

DC recognition is integrated in the device as standard.

No additional commissioning is necessary for activation.



This is a safety-relevant parameter.

The setting is relevant for the dimensioning of the central battery system.

The LED driver is designed to operate on DC voltage and pulsed DC voltage. For a reliable operation, make sure that also in DC emergency operation the LED driver is run within the specified conditions as stated in chapter "4.1 operating window".

Light output level in DC operation: programmable 1 – 50 %
(factory default = 15 %, EOF_i = 0.13).

The voltage-dependent input current of Driver incl. LED module is depending on the used load.

The voltage-dependent no-load current of Driver (without or defect LED module) is for:

AC: < 66 mA

DC: < 3 mA

6.12 Enhanced power on level (ePOL)



The Enhanced Power On Level parameter defines the power level that is set automatically when power is restored after a power failure.

The Enhanced Power On Level can be set to a fixed value (0 – 100 %) or can recall the memory value.

The memory value is the last value the LED driver was set to before the power failure.

This value applies not only in DALI device operating mode, but also in the device operating mode switchDIM.

6.13 DALI default parameters



In order for all luminaires to react the same for each operation (switching, dimming, scene recall ...), these values must be set the same.

These DALI standard parameters are supported by every DALI-2 device.

6.14 Scenes and groups



Each device can be a member of up to 16 groups.

Also, 16 different scene values can be stored in each device.

6.15 Power-up fading



The power-up function offers the opportunity to modify the on behavior.

The time for fading on can be adjusted in a range of 0.2 to 16 seconds.

According to this value, the device dims from 0 % up to the power-on level.

By factory default no fading time is set (= 0 seconds).

6.16 Dimming curve



DALI:

The desired dimming behaviour is selected via two different dimming curves (logarithmic or linear).

The default setting of the dimming behaviour is logarithmic.

6.17 DIP switch configuration

1. The default output current configuration is by DIPSwitch.
2. If output current configuration is realized by DALI interface, DIPSwitch configuration is not available.
3. Enabling DIPSwitch configuration can be done through companionSUITE or masterCONFIGURATOR.

7. Protective features

7.1 Overtemperature protection

The LED driver is protected against temporary thermal overheating. If the temperature limit is exceeded the output current of the LED module(s) is reduced. The temperature protection is activated above $t_{c\ max}$. The activation temperature differs depending on the LED load. On DC operation this function is deactivated to fulfill emergency requirements.

7.2 Short-circuit behaviour

In case of a short-circuit at the LED output the LED output is switched off. After restart of the LED driver the output will be activated again. The restart can either be done via mains reset or via interface (DALI).

7.3 No-load operation

The LED driver will not be damaged in no-load operation. The output will be deactivated and is therefore free of voltage. When connecting an LED load, restart the device to activate the LED output.

7.4 Overload protection

If the maximum load is exceeded by a defined internal limit, the LED driver turns off the LED output. After restart of the LED driver the output will be activated again. The restart can either be done via mains reset or via interface (DALI).

7.5 Insulation between terminals

Insulation	Mains	NTC / LED	DALI	PE
Mains	–	–	basic	basic
NTC / LED	–	–	basic	basic
DALI	basic	basic	–	basic
PE	basic	basic	basic	–

basic ... represents basic insulation.

double ... represents double or reinforced insulation.

8. Miscellaneous

8.1 Insulation and electric strength testing of luminaires

Electronic devices can be damaged by high voltage. This has to be considered during the routine testing of the luminaires in production.

According to IEC 60598-1 Annex Q (informative only!) or ENEC 303-Annex A, each luminaire should be submitted to an insulation test with 500 V_{DC} for 1 second. This test voltage should be connected between the interconnected phase and neutral terminals and the earth terminal. The insulation resistance must be at least 2 MΩ.

As an alternative, IEC 60598-1 Annex Q describes a test of the electrical strength with 1500 V_{AC} (or 1.414 x 1500 V_{DC}). To avoid damage to the electronic devices this test must not be conducted.

The equipotential terminal is used to connect the heat sink and the LED driver to reduce transients.

8.2 Conditions of storage and use

Humidity: 5% up to max. 85%,
not condensed
(max. 56 days/year at 85%)

Storage temperature: -40 °C up to max. +80 °C

The devices have to be acclimatised to the specified temperature range (t_a) before they can be operated.

The LED driver is declared as inbuilt LED controlgear, meaning it is intended to be used within a luminaire enclosure.

If the product is used outside a luminaire, the installation must provide suitable protection for people and environment (e.g. in illuminated ceilings).

8.3 Maximum number of switching cycles

All LED driver are tested with 50,000 switching cycles. The actually achieved number of switching cycles is significantly higher.

8.4 Additional information

Additional technical information at www.tridonic.com → Technical Data

Lifetime declarations are informative and represent no warranty claim. No warranty if device was opened.