

Driver LC 100W 1100–2100mA flexC C EXC

excite series

**Product description**

- _ Constant current LED driver
- _ Adjustable output current between 1,100 and 2,100 mA via ready2mains Programmer or I-SELECT 2 plugs
- _ Max. output power 100 W
- _ Up to 92 % efficiency
- _ Nominal lifetime up to 100,000 h
- _ 5 years guarantee (conditions at <https://www.tridonic.com/en/int/services/manufacturer-guarantee-conditions>)

Housing properties

- _ Casing: polycarbonate, white
- _ Type of protection IP20

Interfaces

- _ ready2mains (configuration via mains)
- _ Terminal blocks: 45° push terminals

Functions

- _ Adjustable output current in 1-mA-steps (ready2mains, I-SELECT 2)
- _ Protective features (overtemperature, short-circuit, overload, no-load, input voltage range)
- _ Intelligent Voltage Guard (overvoltage and undervoltage monitoring)
- _ Suitable for emergency escape lighting systems acc. to EN 50172

Benefits

- _ Application-oriented operating window for maximum compatibility
- _ Best energy savings due to high efficiency
- _ Flexible configuration via ready2mains and I-SELECT 2

Typical applications

- _ For downlight, spotlight and decorative applications

Website

<http://www.tridonic.com/28001572>



Linear



High bay



Decorative



Downlights



Spotlights



Free-standing



Area



Floor | Wall



Street

Driver LC 100W 1100–2100mA flexC C EXC

excite series

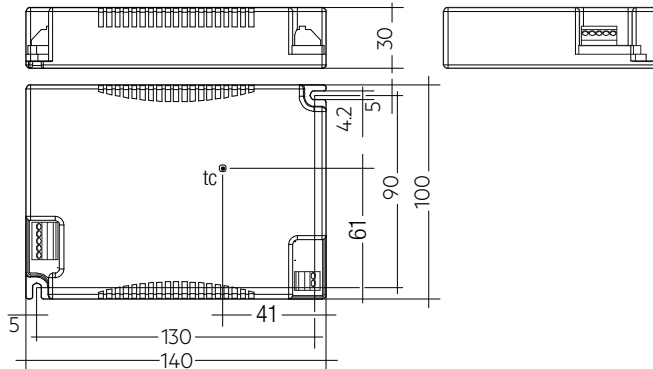

Ordering data

Type	Article number	Packaging, carton	Packaging, pallet	Weight per pc.
LC 100W 1100-2100mA flexC C EXC	28001572	10 pc(s).	500 pc(s).	0.266 kg

Technical data

Rated supply voltage	220 – 240 V
AC voltage range	198 – 264 V
DC voltage range	176 – 280 V
Mains frequency	0 / 50 / 60 Hz
Overvoltage protection	320 V AC, 48 h
Typ. rated current (at 230 V, 50 Hz, full load) ^①	482 mA
Typ. current (220 V, 0 Hz, full load, 66 % dimming level) ^①	342 mA
Leakage current (at 230 V, 50 Hz, full load) ^①	< 250 µA
Max. input power	109 W
Typ. efficiency (at 230 V, 50 Hz, full load) ^①	92 %
λ (at 230 V, 50 Hz, full load)	0.95
Typ. input current in no-load operation	60 mA
Typ. input power in no-load operation	0.111 W
In-rush current (peak / duration)	50.6 A / 210 µs
THD (at 230 V, 50 Hz, full load)	< 10 %
Starting time (at 230 V, 50 Hz, full load)	< 500 ms
Starting time (DC mode)	< 500 ms
Switchover time (AC/DC) ^②	< 0.3 s
Turn off time (at 230 V, 50 Hz, full load)	< 50 ms
Output current tolerance ^③	± 5 %
Max. output current peak (non-repetitive)	≤ output current + 35 %
Output LF current ripple (< 120 Hz)	± 5 %
Output P _{ST_LM} (at full load)	≤ 1
Output SVM (at full load)	≤ 0.4
Max. output voltage (U-OUT)	60 V
Mains surge capability (between L - N)	1 kV
Mains surge capability (between L/N - PE)	2 kV
Burst / surge peaks output side against PE	< 500 V
Type of protection	IP20
Lifetime	up to 100,000 h
Guarantee (conditions at www.tridonic.com)	5 Year(s)
Dimensions L x W x H	140 x 100 x 30 mm

Approval marks



Standards

EN 55015, EN 61000-3-2, EN 61000-3-3, EN 61347-1, EN 61347-2-13, EN 62384, EN 61547, according to EN 50172, according to EN 60598-2-22

Specific technical data

Type	Output current ^②	Min. output voltage	Max. output voltage	Max. output power	Typ. power consumption (at 230 V, 50 Hz, full load)	Typ. current consumption (at 230 V, 50 Hz, full load)	tc point max.	Ambient temperature ta	I-SELECT 2 resistor value ^⑤
LC 100W 1100-2100mA flexC C EXC	1,100 mA	20 V	54.0 V	59.4 W	65.1 W	297 mA	80 °C	-25 ... +50 °C	-
LC 100W 1100-2100mA flexC C EXC	1,150 mA	20 V	54.0 V	62.4 W	68.1 W	309 mA	80 °C	-25 ... +50 °C	4.35 kΩ
LC 100W 1100-2100mA flexC C EXC	1,200 mA	20 V	54.0 V	64.8 W	71.4 W	323 mA	80 °C	-25 ... +50 °C	4.17 kΩ
LC 100W 1100-2100mA flexC C EXC	1,250 mA	20 V	54.0 V	68.0 W	74.0 W	334 mA	80 °C	-25 ... +50 °C	4.00 kΩ
LC 100W 1100-2100mA flexC C EXC	1,300 mA	20 V	54.0 V	70.2 W	77.0 W	347 mA	80 °C	-25 ... +50 °C	3.85 kΩ
LC 100W 1100-2100mA flexC C EXC	1,350 mA	20 V	54.0 V	73.3 W	79.7 W	358 mA	80 °C	-25 ... +50 °C	3.70 kΩ
LC 100W 1100-2100mA flexC C EXC	1,400 mA	20 V	54.0 V	75.6 W	82.1 W	369 mA	80 °C	-25 ... +50 °C	3.57 kΩ
LC 100W 1100-2100mA flexC C EXC	1,450 mA	20 V	54.0 V	78.2 W	84.8 W	380 mA	80 °C	-25 ... +50 °C	3.45 kΩ
LC 100W 1100-2100mA flexC C EXC	1,500 mA	20 V	54.0 V	81.0 W	88.1 W	394 mA	80 °C	-25 ... +50 °C	3.33 kΩ
LC 100W 1100-2100mA flexC C EXC	1,550 mA	20 V	54.0 V	83.5 W	90.5 W	404 mA	80 °C	-25 ... +50 °C	3.23 kΩ
LC 100W 1100-2100mA flexC C EXC	1,600 mA	20 V	54.0 V	86.4 W	94.1 W	420 mA	80 °C	-25 ... +50 °C	3.13 kΩ
LC 100W 1100-2100mA flexC C EXC	1,650 mA	20 V	54.0 V	89.1 W	96.5 W	430 mA	80 °C	-25 ... +50 °C	3.03 kΩ
LC 100W 1100-2100mA flexC C EXC	1,700 mA	20 V	54.0 V	91.8 W	99.3 W	442 mA	80 °C	-25 ... +50 °C	2.94 kΩ
LC 100W 1100-2100mA flexC C EXC	1,750 mA	20 V	54.0 V	93.7 W	101.6 W	451 mA	80 °C	-25 ... +50 °C	2.86 kΩ
LC 100W 1100-2100mA flexC C EXC	1,800 mA	20 V	54.0 V	97.2 W	105.7 W	469 mA	80 °C	-25 ... +50 °C	2.78 kΩ
LC 100W 1100-2100mA flexC C EXC	1,850 mA	20 V	54.0 V	99.8 W	107.9 W	479 mA	80 °C	-25 ... +50 °C	2.70 kΩ
LC 100W 1100-2100mA flexC C EXC	1,900 mA	20 V	52.6 V	99.9 W	107.8 W	478 mA	80 °C	-25 ... +50 °C	2.63 kΩ
LC 100W 1100-2100mA flexC C EXC	1,950 mA	20 V	51.3 V	99.8 W	108.0 W	479 mA	80 °C	-25 ... +50 °C	2.56 kΩ
LC 100W 1100-2100mA flexC C EXC	2,000 mA	20 V	50.0 V	100.0 W	108.1 W	480 mA	80 °C	-25 ... +50 °C	2.50 kΩ
LC 100W 1100-2100mA flexC C EXC	2,050 mA	20 V	48.8 V	100.0 W	108.4 W	481 mA	80 °C	-25 ... +50 °C	2.44 kΩ
LC 100W 1100-2100mA flexC C EXC	2,100 mA	20 V	47.6 V	100.0 W	108.5 W	482 mA	80 °C	-25 ... +50 °C	0.00 kΩ

① Depending on the selected output current.

② Valid for immediate change of power supply type otherwise the starting time is valid.

③ Output current is mean value.

④ The table only lists a number of possible operating points but does not cover each single point. The output current can be set within the total value range in 1-mA-steps.

⑤ Not compatible with I-SELECT (generation 1). Calculated resistor value.

I-SELECT 2 PLUG PRE / EXC

Accessory



Product description

- _ Ready-for-use resistor to set output current value
- _ Compatible with LED driver featuring I-select 2 interface; not compatible with I-SELECT (generation 1)
- _ Resistor is base insulated
- _ Resistor power 0.25 W
- _ Current tolerance $\pm 2\%$ additional to output current tolerance
- _ Compatible with LED driver series PRE and EXC

Example of calculation

- _ $R [k\Omega] = 5 V / I_{out} [mA] \times 1000$
- _ E96 resistor value used
- _ Resistor value tolerance $\leq 1\%$; resistor power $\geq 0.1 W$; base insulation necessary
- _ When using a resistor value beyond the specified range, the output current will automatically be set to the minimum value (resistor value too big), respectively to the maximum value (resistor value too small)

Website

<http://www.tridonic.com/28001126>



Ordering data

Type	Article number	Colour	Marking	Current	Resistor value	Packaging, bag	Weight per pc.
I-SELECT 2 PLUG 1100MA BL	28001126	Blue	1100 mA	1,100 mA	4.53 k Ω	10 pc(s).	0.001 kg
I-SELECT 2 PLUG 1150MA BL	28001127	Blue	1150 mA	1,150 mA	4.32 k Ω	10 pc(s).	0.001 kg
I-SELECT 2 PLUG 1200MA BL	28001128	Blue	1200 mA	1,200 mA	4.12 k Ω	10 pc(s).	0.001 kg
I-SELECT 2 PLUG 1250MA BL	28001129	Blue	1250 mA	1,250 mA	4.02 k Ω	10 pc(s).	0.001 kg
I-SELECT 2 PLUG 1300MA BL	28001130	Blue	1300 mA	1,300 mA	3.83 k Ω	10 pc(s).	0.001 kg
I-SELECT 2 PLUG 1350MA BL	28001131	Blue	1350 mA	1,350 mA	3.74 k Ω	10 pc(s).	0.001 kg
I-SELECT 2 PLUG 1400MA BL	28001132	Blue	1400 mA	1,400 mA	3.57 k Ω	10 pc(s).	0.001 kg
I-SELECT 2 PLUG 1500MA BL	28001133	Blue	1500 mA	1,500 mA	3.32 k Ω	10 pc(s).	0.001 kg
I-SELECT 2 PLUG 1600MA BL	28001134	Blue	1600 mA	1,600 mA	3.16 k Ω	10 pc(s).	0.001 kg
I-SELECT 2 PLUG 1700MA BL	28001135	Blue	1700 mA	1,700 mA	2.94 k Ω	10 pc(s).	0.001 kg
I-SELECT 2 PLUG 1800MA BL	28001136	Blue	1800 mA	1,800 mA	2.80 k Ω	10 pc(s).	0.001 kg
I-SELECT 2 PLUG 1900MA BL	28001137	Blue	1900 mA	1,900 mA	2.61 k Ω	10 pc(s).	0.001 kg
I-SELECT 2 PLUG 2000MA BL	28001138	Blue	2000 mA	2,000 mA	2.49 k Ω	10 pc(s).	0.001 kg
I-SELECT 2 PLUG 2100MA BL	28001139	Blue	2100 mA	2,100 mA	2.37 k Ω	10 pc(s).	0.001 kg
I-SELECT 2 PLUG MAX BL	28001099	Blue	MAX	MAX	0.00 k Ω	10 pc(s).	0.001 kg

1. Standards

EN 55015
 EN 61000-3-2
 EN 61000-3-3
 EN 61347-1
 EN 61347-2-13
 EN 62384
 EN 61547

According to EN 50172 for use in central battery systems

According to EN 60598-2-22 suitable for emergency lighting installations

2. Thermal details and lifetime

2.1 Expected lifetime

Expected lifetime				
Type	Output current	t_a	40 °C	50 °C
LC 100W 1100-2100mA flexC C EXC	1,100 – 2,100 mA	t_c	70 °C	80 °C
		Lifetime	> 100,000 h	90,000 h

The LED driver is designed for a lifetime stated above under reference conditions and with a failure probability of less than 10 %.

The relation of t_c to t_a temperature depends also on the luminaire design.

If the measured t_c temperature is approx. 5 K below t_c max., t_a temperature should be checked and eventually critical components (e.g. ELCAP) measured. Detailed information on request.

3. Installation / wiring

3.1 Circuit diagram

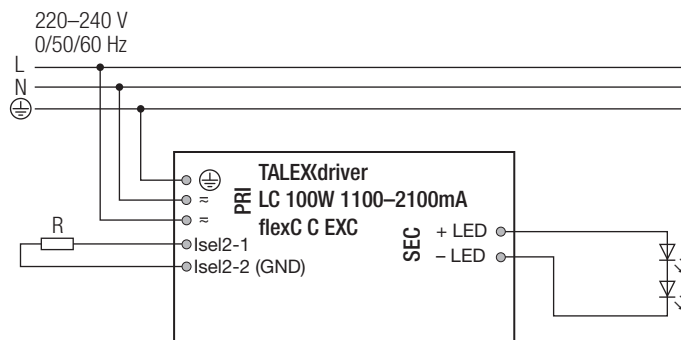

3.2 Wiring type and cross section

For wiring use stranded wire with ferrules or solid wire from 0.2–1.5 mm². Strip 8.5–9.5 mm of insulation from the cables to ensure perfect operation of the push-wire terminals.

Use one wire for each terminal connector only.

LED module/LED driver/supply

wire preparation:
 0.2 – 1.5 mm²

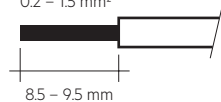

1.1 Glow wire test

according to EN 61347-1 with increased temperature of 850 °C passed.

3.3 Loose wiring

Press down the "push button" and remove the cable from front.

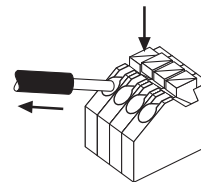

3.4 Wiring guidelines

- Run the secondary lines separately from the mains connections and lines to achieve good EMC performance.
- The max. secondary cable length is 2 m (4 m circuit).
- For good EMC performance, keep the LED wiring as short as possible.
- Secondary switching is not permitted.
- The LED driver has no inverse-polarity protection on the secondary side. Wrong polarity can damage LED modules with no inverse-polarity protection.
- Wrong wiring of the LED driver can lead to malfunction or irreparable damage.
- To avoid damage of the Driver, the wiring must be protected against short circuits to earth (sharp edged metal parts, metal cable clips, louver, etc.).

3.5 Hot plug-in

Hot plug-in is not supported due to residual output voltage of > 0 V. When connecting an LED load, restart the device to activate the LED output. This can be done via mains reset.

3.6 Earth connection

The earth connection is conducted as protection earth (PE). If the LED driver will be earthed, protection earth (PE) has to be used. There is no earth connection required for the functionality of the LED driver.

Earth connection is recommended to improve following behaviour:

- Electromagnetic interferences (EMI)
- Transmission of mains transients to the LED output

In general it is recommended to earth the LED driver if the LED module is mounted on earthed luminaire parts respectively heat sinks and thereby representing a high capacity against earth.

3.7 I-SELECT 2 resistors connected via cable

For details see:
http://www.tridonic.com/com/en/download/technical/LCA_PRE_LC_EXC_ProductManual_en.pdf

3.8 Installation note

Max. torque at the clamping screw: 0.5 Nm / M4

4. Electrical values

4.1 Operating window

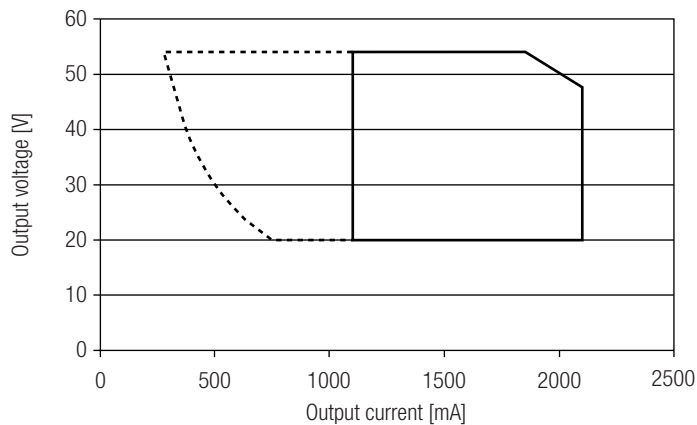

— Operating window
 - - - DC emergency operation window

Make sure that the LED driver is operated within the given window under all operating conditions. Special attention needs to be paid at dimming and DC emergency operation as the forward voltage of the connected LED modules varies with the dimming level, due to the implemented amplitude dimming technology. Coming below the specified minimum output voltage of the LED driver may cause the device to shut-down.

See chapter "6.7 DC emergency operation" for more information.

4.2 Efficiency vs load

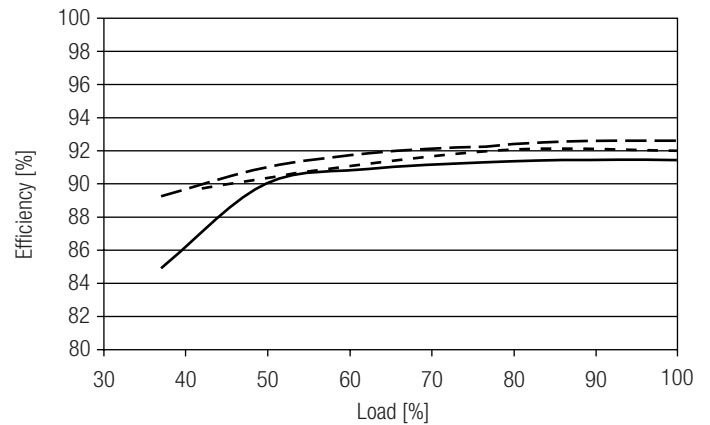

4.3 Power factor vs load

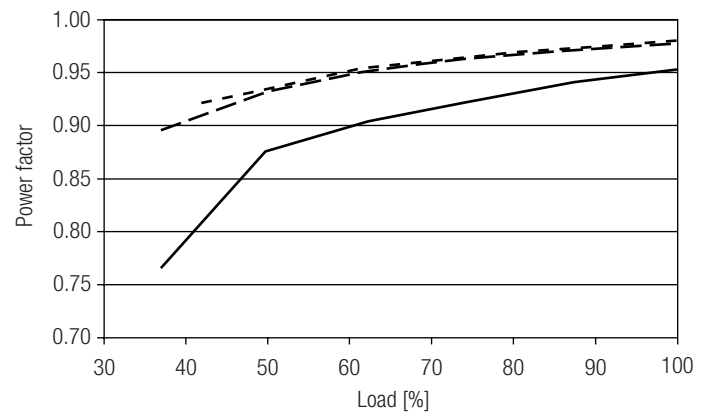

4.4 THD vs load (without harmonic < 5 mA or 0.6 % of the input current)

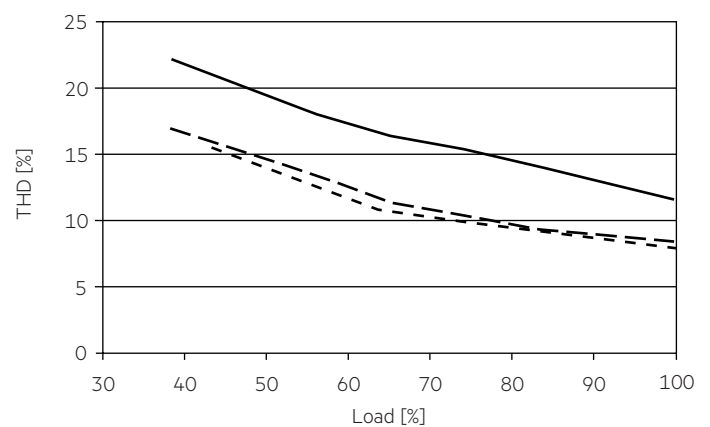

— 1100 mA
 - - - 1750 mA
 - . - . 2100 mA

100 % load corresponds to the max. output power (full load) according to the table on page 2.

4.5 Maximum loading of automatic circuit breakers in relation to inrush current

Automatic circuit breaker type	C10	C13	C16	C20	B10	B13	B16	B20	Inrush current	
Installation Ø	1.5 mm ²	1.5 mm ²	2.5 mm ²	2.5 mm ²	1.5 mm ²	1.5 mm ²	2.5 mm ²	2.5 mm ²	I_{max}	time
LC 100W 1100-2100mA flexC C EXC	13	17	22	28	8	10	13	16	50.6 A	210 µs

These are max. values calculated out of inrush current! Please consider not to exceed the maximum rated continuous current of the circuit breaker. Calculation uses typical values from ABB series S200 as a reference. Actual values may differ due to used circuit breaker types and installation environment.

4.6 Harmonic distortion in the mains supply (at 230 V / 50 Hz and full load) in %

	THD	3.	5.	7.	9.	11.
LC 100W 1100-2100mA flexC C EXC	< 8	< 5	< 4	< 5	< 3	< 2

Acc. to 61000-3-2. Harmonics < 5 mA or < 0.6 % (whatever is greater) of the input current are not considered for calculation of THD.

5. Interfaces / communication

5.1 Configuration input ready2mains (L, N)

The digital ready2mains protocol is modulated onto the mains signal which is wired to the mains terminal (L and N).

6. Functions

6.1 Function: adjustable current

The output current of the LED driver can be adjusted in a certain range. For adjustment there are two options available.

Option 1: I-SELECT 2

By inserting a suitable resistor or third party resistor into the I-SELECT 2 interface, the current value can be adjusted. The relationship between output current and resistor value can be found in the chapter "Accessories I-SELECT 2 Plugs".



Please note that the resistor values for I-SELECT 2 are not compatible with I-SELECT (generation 1). Installation of an incorrect resistor may cause irreparable damage to the LED module(s).

Resistors for the main output current values can be ordered from Tridonic (see accessories).

Option 2: ready2mains

Adjustment is done by the ready2mains Programmer and the corresponding configuration software (see ready2mains documentation).



Current adjustment can only be done five times over ready2mains. To program the LED driver a connected load is necessary that is within the operating window of the LED driver.

The priority for current adjustment methods is I-SELECT 2 followed by ready2mains (lowest priority).

6.2 ready2mains – configuration

The ready2mains interface enables the configuration of the mostly used parameters via the mains wiring.

In the case of EXC LED driver, it is the LED output current as well as an optional lockbit to prevent any accidental configuration at a later stage.

The configuration is done via the ready2mains Programmer, either directly at the Programmer itself or via a respective software tool. For details on the configuration via ready2mains see the technical information of the Programmer and its tools.

6.3 Short-circuit behaviour

In case of a short-circuit at the LED output the LED output is switched off. After restart of the LED driver the output will be activated again.

The restart can be done via mains reset.

6.4 No-load operation

The LED driver will not be damaged in no-load operation. The output will be deactivated and is therefore free of voltage. If a LED load is connected the device has to be restarted before the output will be activated again.

6.5 Overload protection

If the maximum load is exceeded by a defined internal limit, the LED driver turns off the LED output. After restart of the LED driver the output will be activated again.

The restart can be done via mains reset.

6.6 Overtemperature protection

The LED driver is protected against temporary thermal overheating. If the temperature limit is exceeded the output current of the LED module(s) is reduced. The temperature protection is activated above $t_{c\ max}$. The activation temperature differs depending on the LED load. On DC operation this function is deactivated to fulfill emergency requirements.

6.7 DC emergency operation

The LED driver is designed to operate on DC voltage and pulsed DC voltage. For a reliable operation, make sure that also in DC emergency operation the LED driver is run within the specified conditions as stated in chapter "4.1 Operating window".

Light output level in DC operation (EOF_i): 66 % (cannot be adjusted)

The voltage-dependent input current of Driver incl. LED module is depending on the used load.

The nominal voltage-dependent no-load current of Driver (without or defect LED module) is for:

AC: 50.8 mA (at 230 V, 50 Hz)

DC: 7 – 10 mA (at 275 – 186 V, 0 Hz)

6.8 Intelligent Voltage Guard

Intelligent Voltage Guard is the name of the electronic monitoring of the mains voltage. It immediately shows if the mains voltage rises above certain thresholds. Measures can then be taken quickly to prevent damage to the LED driver.

- If the mains voltage rises above approx. 280 V_{rms} (voltage depends on the LED driver type), the LED light starts flashing on and off.
- To avoid a damage of the LED driver the mains supply has to be switched off at this signal.

7. Miscellaneous

7.1 Insulation and electric strength testing of luminaires

Electronic devices can be damaged by high voltage. This has to be considered during the routine testing of the luminaires in production.

According to IEC 60598-1 Annex Q (informative only!) or ENEC 303-Annex A, each luminaire should be submitted to an insulation test with 500 V_{DC} for one second. This test voltage should be connected between the interconnected phase and neutral terminals and the earth terminal. The insulation resistance must be at least 2 MΩ.

As an alternative, IEC 60598-1 Annex Q describes a test of the electrical strength with 1500 V_{AC} (or 1.414 x 1500 V_{DC}). To avoid damage to the electronic devices this test must not be conducted.

7.2 Conditions of use and storage

Humidity: 5 % up to max. 85 %, not condensed (max. 56 days/year at 85 %)

Storage temperature: -40 °C up to max. +80 °C

The devices have to be acclimatised to the specified temperature range (ta) before they can be operated.

The LED driver is declared as inbuilt LED controlgear, meaning it is intended to be used within a luminaire enclosure.

If the product is used outside a luminaire, the installation must provide suitable protection for people and environment (e.g. in illuminated ceilings).

7.3 Maximum number of switching cycles

All LED driver are tested with 50,000 switching cycles.

The actually achieved number of switching cycles is significantly higher.

7.4 Additional information

Additional technical information at www.tridonic.com → Technical Data

Lifetime declarations are informative and represent no warranty claim. No warranty if device was opened.