

Driver LCU 48V 75W DC-STR DIM SR
Dimming



Product description

- _ Independent dimmable DC-String constant voltage LED driver
- _ Compatible with other DC-String components
- _ DALI bridge with DC powerline communication (PLC)
- _ one4all interface (corridorFUNCTION, switchDIM, DALI, DSI)
- _ Max. output power 75 W
- _ Up to 91 % efficiency
- _ Nominal lifetime up to 50,000 h
- _ For luminaires of protection class I and protection class II
- _ Temperature protection as per EN 61347-2-13 C5e
- _ 5 years guarantee (conditions at <https://www.tridonic.com/en/int/services/manufacturer-guarantee-conditions>)

Housing properties

- _ Casing: polycarbonate, white
- _ Type of protection IP20

Functions

- _ DC-String compatible
- _ Intelligent Temperature Guard (overtemperature protection)
- _ Short-circuit protection
- _ Overload protection

Website

<http://www.tridonic.com/28001233>



Linear



High bay



Decorative



Downlights



Spotlights



Free-standing



Area



Floor | Wall



Street

1. Standards

EN 55015
 EN 61000-3-2
 EN 61000-3-3
 EN 61347-1
 EN 61347-2-13
 EN 62384
 EN 61547

2. Thermal details and lifetime

2.1 Expected lifetime

Expected lifetime				
	ta	50 °C	55 °C	
Type	tc	65 °C	70 °C	Load
		85,000 h	65,000 h	75 – 100 %
LCU 48V 75W DC-STR PLC SR	Lifetime	85,000 h	65,000 h	50 – 74 %
		85,000 h	65,000 h	25 – 49 %
		85,000 h	65,000 h	0 – 24 %

The LED control gear is designed for a lifetime stated above under reference conditions and with a failure probability of less than 10 %.

The relation of tc to ta temperature depends also on the luminaire design.

If the measured tc temperature is approx. 5 K below tc max., ta temperature should be checked and eventually critical components (e.g. ELCAP) measured. Detailed information on request.

3. Installation / wiring

3.1 Circuit diagram

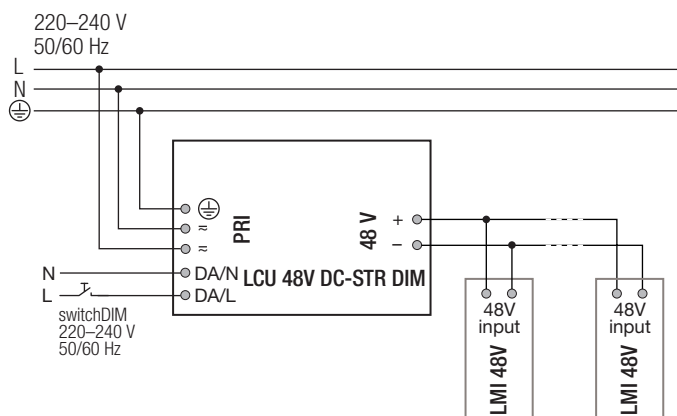
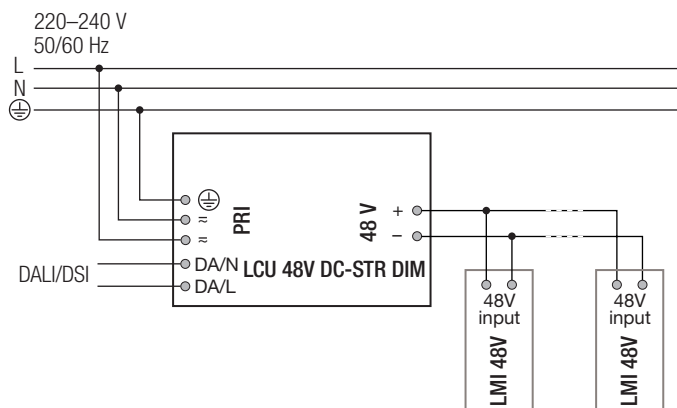

3.2 Mains supply wiring

For wiring use stranded wire with ferrules or solid wire up to 2.5 mm². Strip 10–11 mm of insulation from the cables to ensure perfect operation of the push terminals.

Use one wire for each terminal connector only.
 Use each strain relief channel for one cable only.

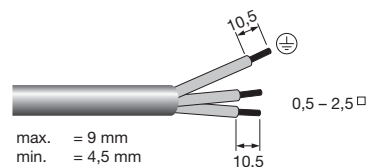

3.3 Output wiring (48 V bus)

For wiring use stranded wire with ferrules or solid wire from 0.2 – 2.5 mm². Strip 9 – 10 mm of insulation from the cables to ensure perfect operation of the push-wire terminals.

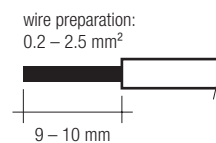

Use one wire for each terminal connector only.
 Use each strain relief channel for one cable only.

3.4 Loose wiring

Press down the “push button” and remove the cable from front.

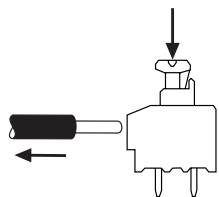

3.5 Fixing conditions when using as independent Driver with Clip-On

Dry, acidfree, oilfree, fatfree. It is not allowed to exceed the maximum ambient temperature (t_a) stated on the device. Minimum distances stated below are recommendations and depend on the actual luminaire.

Is not suitable for fixing in corner.

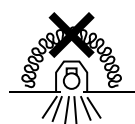
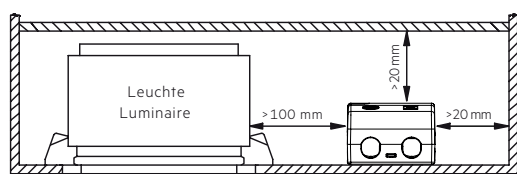

Device not suitable for covering with thermally insulating material according to IEC 60598-1 Ed.9

3.5 Wiring guidelines

- The 48 V cables should be run separately from the mains connections and mains cables to ensure good EMC conditions.
- The 48 V DC output wiring should be kept as short as possible to ensure good EMC.

When using an unshielded standard cable:

No additional measures are required for cable lengths of up to 5 meters.

The use of a ferrite is recommended for cable lengths between 5 and 20 meters (e.g. Wuerth 742 727 33).

When using a shielded cable with grounded shield:

No additional measures are required for cable lengths of up to 15 meters.

The use of a ferrite is recommended for cables longer than 15 meters (e.g. Wuerth 742 727 33).

- The max. secondary cable length is 30 m (60 m circuit) till beginning of a grounded metal track light. If track light is not grounded or made of plastic, cable length including track light is 30 m. Inside the track light cable length is limited by voltage drop that last LMI 48V in the track light is still supplied with minimum 46 V.
- Secondary switching is not permitted.
- To avoid damage of the Driver, the wiring must be protected against short circuits to earth (sharp edged metal parts, metal cable clips, louver, etc.).
- Additional systems or lines can compromise or disrupt the PLC communication in the DC string system. Therefore do not install any other systems or cables parallel to the DC string system cables.

3.7 Hot plug-in

Configured parameters of DC/DC-LED driver (LMI DIM) are not saved if they are unplugged.

For saving parameters a mains reset of the DC power supply is necessary.

A delays of 5 seconds is also mandatory before turning power on afterwards.

Maximum number of LMI LED drivers is limited by 20.

3.8 Function of the earth terminal ⊕

The device has to be earthed to fulfill EMI requirements.

4. Electrical values

4.1 Efficiency vs. load

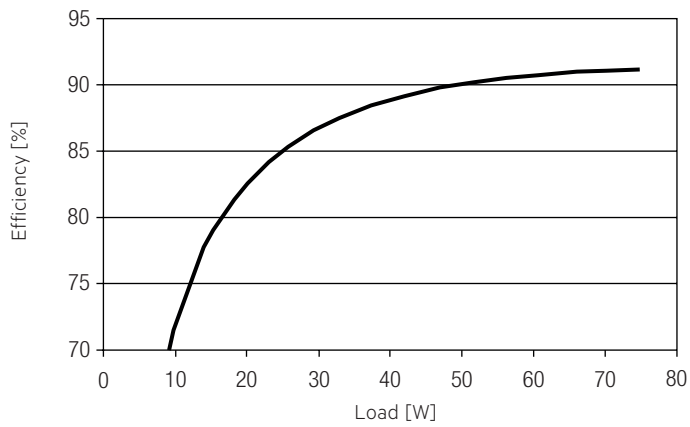

4.4 Input current vs. Load

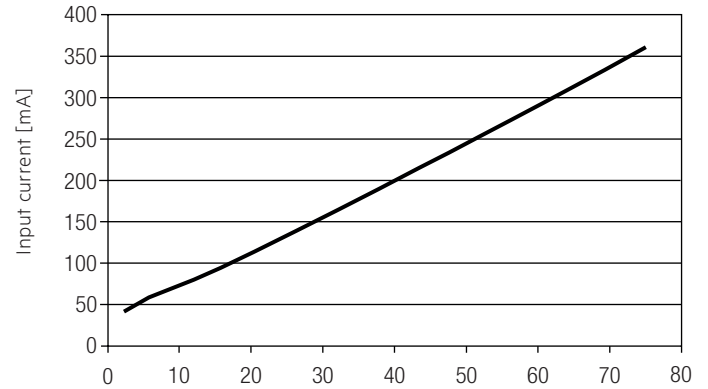

4.2 Power factor vs. Load

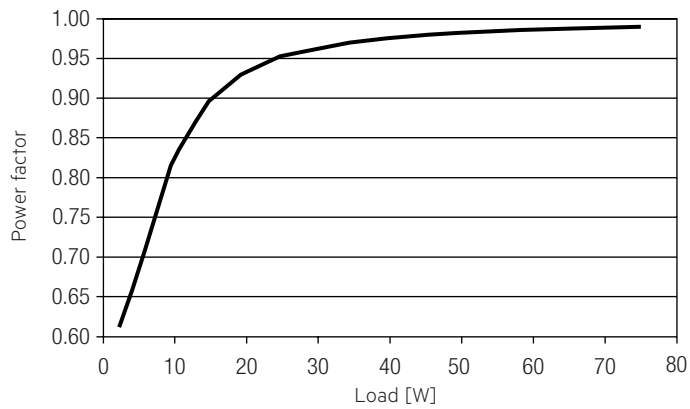

4.5 THD vs. Load

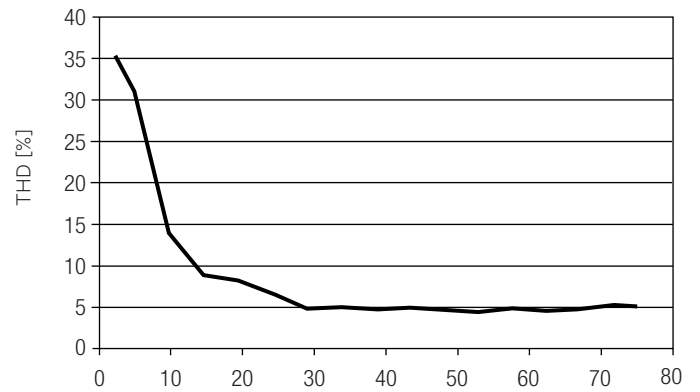

4.3 Input power vs. Load

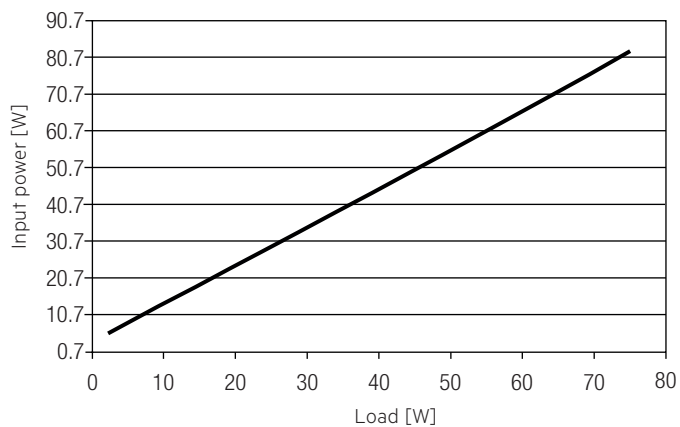

4.6 Maximum loading of automatic circuit breakers in relation to inrush current

Automatic circuit breaker type	C10	C13	C16	C20	B10	B13	B16	B20	Inrush current	
Installation Ø	1.5 mm ²	1.5 mm ²	2.5 mm ²	2.5 mm ²	1.5 mm ²	1.5 mm ²	2.5 mm ²	2.5 mm ²	I_{max}	time
LCU 48V 75W DC-STR DIM SR	15	18	23	30	9	11	14	18	48 A	145 µs

These are max. values calculated out of inrush current! Please consider not to exceed the maximum rated continuous current of the circuit breaker.

Calculation uses typical values from ABB series S200 as a reference.

Actual values may differ due to used circuit breaker types and installation environment.

4.7 Harmonic distortion in the mains supply (at 230 V / 50 Hz and full load) in %

	THD	3.	5.	7.	9.	11.
LCU 48V 75W DC-STR DIM SR	5	2	1	1	1	1

4.8 Dimming

Dimming range 70 mA to 100 % of nominal current

Digital control with:

Programmable parameter:

Minimum dimming level

Maximum dimming level

Default minimum = depending on nominal current level

Default maximum = 100 %

Dimming curve is adapted to the eye sensitiveness.

Dimming is realized by amplitude dimming.

4.9 Dimming characteristics

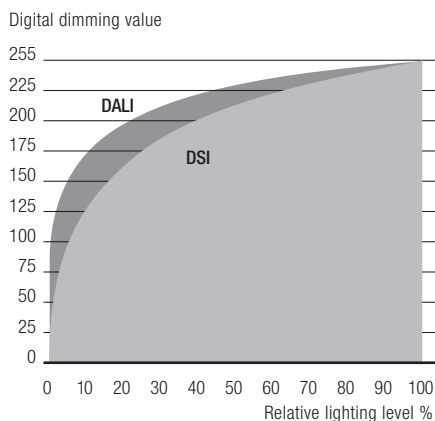

Dimming characteristics as seen by the human eye

5. Interfaces / communication

5.1 Control input (DA/N, DA/L)

Digital DALI signal or switchDIM can be wired on the same terminals (DA/N and DA/L).

The control input is non-polar for digital control signals (DALI, DSI). The control signal is not SELV. Control cable has to be installed in accordance to the requirements of low voltage installations.

Different functions depending on each module.

5.2 switchDIM

Integrated switchDIM function allows a direct connection of a pushbutton for dimming and switching.

Brief push (< 0.6 s) switches LED control gear ON and OFF. The dimm level is saved at power-down and restored at power-up.

When the pushbutton is held, LED modules are dimmed. After repush the LED modules are dimmed in the opposite direction.

In installations with LED control gears with different dimming levels or opposite dimming directions (e.g. after a system extension), all LED control gears can be synchronized to 50 % dimming level by a 10 s push.

Use of pushbutton with indicator lamp is not permitted.

5.3 PowerLineCommunication (PLC)

The communication between the LED control gear and the LMI DC/DC-LED Driver is done over power line. The DALI signal will be modulated by the LED control gear and will be sent over the 48 V DC signal to the DC/DC-LED driver.

6. Functions

6.1 Short-circuit behaviour

In case of a short-circuit at the output the output is switched off. After restart of the DC power supply the output will be activated again. The restart can be done via mains reset.

6.2 No-load operation

The DC power supply will not be damaged in no-load operation.

6.3 Overload protection

If the output power range is exceeded by a defined internal limit, the DC power supply will give a signal to the DC/DC-LED driver, it will blink 5 times. After a break of 30 seconds, it will check again:

- If there is no overload anymore, the device will switch back to normal operation.
- If there is still overload, the device will blink again 5 times.

6.4 Overtemperature protection

The DC power supply will blink 3 times, after 30 s break, it checks again, if:

- there is no overtemperature, then the device will go in normal operation.
- there is still overtemperature, then the device will blink again 3 times.

6.5 corridorFUNCTION

Is set in the DC/DC-LED driver.

6.6 Software / programming

With appropriate software and a interface different functions can be activated and various parameters can be configured in the LED control gear. To do so, a DALI-USB and the software (masterCONFIGURATOR) are required.

6.7 masterCONFIGURATOR

From version 2.8:

For programming functions (power-up fading, corridorFUNCTION) and device settings (fade time, ePowerOnLevel etc.).

For further information see masterCONFIGURATOR manual.

7. Miscellaneous

7.1 Insulation and electric strength testing of luminaires

Electronic devices can be damaged by high voltage. This has to be considered during the routine testing of the luminaires in production.

According to IEC 60598-1 Annex Q (informative only!) or ENEC 303-Annex A, each luminaire should be submitted to an insulation test with 500 V_{DC} for 1 second. This test voltage should be connected between the interconnected phase and neutral terminals and the earth terminal. The insulation resistance must be at least 2 MΩ.

As an alternative, IEC 60598-1 Annex Q describes a test of the electrical strength with 1500 V_{AC} (or 1.414 x 1500 V_{DC}). To avoid damage to the electronic devices this test must not be conducted.

7.2 Conditions of use and storage

Humidity: 5 % up to max. 85 %,
not condensed
(max. 56 days/year at 85 %)

Storage temperature: -40 °C up to max. +80 °C

The devices have to be acclimatised to the specified temperature range (ta) before they can be operated.

7.3 Additional information

Additional technical information at www.tridonic.com → Technical Data

Lifetime declarations are informative and represent no warranty claim. No warranty if device was opened.