

Driver LCA 75W 250–550mA one4all Ip PRE

21 mm premium series

**Product description**

- _ NEW: lumDATA (DALI-2 part ext. 251, 252 and 253)
- _ Dimmable built-in constant current LED driver
- _ Dimming range 1 to 100 %
- _ For luminaires of protection class I and protection class II
- _ Output current adjustable between 250 – 550 mA
- _ Max. output power 75 W
- _ Up to 92 % efficiency
- _ Power input on stand-by < 0.15 W
- _ Nominal lifetime up to 100,000 h
- _ 5 years guarantee (conditions at <https://www.tridonic.com/en/int/services/manufacturer-guarantee-conditions>)

Housing properties

- _ Low profile metal casing with white cover
- _ Type of protection IP20

Interfaces

- _ one4all (DALI-2 DT 6, DSI, switchDIM, corridorFUNCTION)
- _ ready2mains (configuration and dimming via mains)
- _ Terminal blocks: 0° push terminals

Functions

- _ Adjustable output current in 1-mA-steps (DALI, ready2mains, I-SELECT 2)
- _ Fulfills DALI-2 parts: 251 (Luminaire data), 252 (Energy reporting and 253 (Diagnostics & Maintenance)
- _ Constant light output function (CLO)
- _ Power-up fading at AC
- _ Configurable via ready2mains
- _ Switch off the driver with fade2zero
- _ Service monitor to log certain events
- _ Protective features (overtemperature, short-circuit, overload, no-load, input voltage range, reduced surge amplification)
- _ Suitable for emergency escape lighting systems acc. to EN 50172

Benefits

- _ Flexible configuration via companionSUITE
- _ Application-oriented operating window for maximum compatibility
- _ Best energy savings due to low stand-by losses and high efficiency
- _ Flexible configuration via DALI, ready2mains and I-SELECT 2
- _ Reliability proven by lifetime up to 100,000 h and 5 years guarantee (conditions at <https://www.tridonic.com/en/int/services/manufacturer-guarantee-conditions>)

Typical applications

- _ For linear/area lighting in office applications

Website

<http://www.tridonic.com/28001250>



Linear



High bay



Decorative



Downlights



Spotlights



Free-standing



Area



Floor | Wall



Street

Driver LCA 75W 250–550mA one4all Ip PRE

21 mm premium series

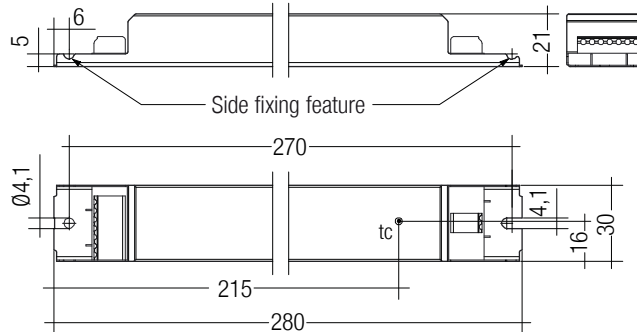

Ordering data

| Type | Article number | Packaging, carton | Packaging, pallet | Weight per pc. |
|----------------------------------|----------------|-------------------|-------------------|----------------|
| LCA 75W 250-550mA one4all Ip PRE | 28001250 | 10 pc(s). | 720 pc(s). | 0.21 kg |

Technical data

| | |
|---|-------------------------|
| Rated supply voltage | 220 – 240 V |
| AC voltage range | 198 – 264 V |
| DC voltage range | 176 – 280 V |
| Mains frequency | 0 / 50 / 60 Hz |
| Overvoltage protection | 320 V AC, 48 h |
| Typ. current (at 230 V, 50 Hz, full load) ^{①②} | 192 – 358 mA |
| Typ. current (220 V, 0 Hz, full load, 15 % dimming level) ^③ | 45.5 – 69.6 mA |
| Leakage current (at 230 V, 50 Hz, full load) ^{①②} | < 150 µA |
| Max. input power | 81.7 W |
| Typ. efficiency (at 230 V, 50 Hz, full load) ^② | 92 % |
| λ over full operating range (max.) | 0.99 |
| λ over full operating range (min.) | 0.83C |
| Typ. power consumption on stand-by ^③ | < 0.15 W |
| Typ. input current in no-load operation | 23 mA |
| Typ. input power in no-load operation | 0.44 W |
| In-rush current (peak / duration) | 29 A / 155 µs |
| THD (at 230 V, 50 Hz, full load) ^① | < 4.7 % |
| Starting time (at 230 V, 50 Hz, full load) ^① | < 0.6 s |
| Starting time (DC mode) | < 0.3 s |
| Switchover time (AC/DC) ^④ | < 0.2 s |
| Turn off time (at 230 V, 50 Hz, full load) | < 20 ms |
| Output current tolerance ^{①⑤} | ± 3 % |
| Max. output current peak (non-repetitive) | ≤ output current + 40 % |
| Output LF current ripple (< 120 Hz) | ± 5 % |
| Output P_ST_LM (at full load) | ≤ 1 |
| Output SVM (at full load) | ≤ 0.4 |
| Max. output voltage (U-OUT) | 250 V |
| Dimming range | 1 – 100 % |
| Mains surge capability (between L - N) | 1 kV |
| Mains surge capability (between L/N - PE) | 2 kV |
| Surge voltage at output side (against PE) | < 0.5 kV |
| Type of protection | IP20 |
| Lifetime | up to 100,000 h |
| Guarantee (conditions at www.tridonic.com) | 5 Year(s) |
| Dimensions L x W x H | 280 x 30 x 21 mm |

Approval marks



Standards

EN 55015, EN 61000-3-2, EN 61000-3-3, EN 61347-1, EN 61347-2-13, EN 62384, EN 61547, EN 62386-101, EN 62386-102, EN 62386-207 (DALI-2), according to EN 50172, according to EN 60598-2-22

Specific technical data

| Type | Output current ^① | Min. output voltage | Max. output voltage | Max. output power | Typ. power consumption (at 230 V, 50 Hz, full load) | Typ. current consumption (at 230 V, 50 Hz, full load) | t _c point max. | Ambient temperature t _a | I-SELECT 2 resistor value ^⑦ |
|----------------------------------|-----------------------------|---------------------|---------------------|-------------------|---|---|---------------------------|------------------------------------|--|
| LCA 75W 250-550mA one4all Ip PRE | 250 mA | 80 V | 150 V | 37.5 W | 42.1 W | 185 mA | 80 °C | -25 ... +60 °C | - |
| LCA 75W 250-550mA one4all Ip PRE | 275 mA | 80 V | 150 V | 41.3 W | 45.9 W | 201 mA | 80 °C | -25 ... +60 °C | 18.18 kΩ |
| LCA 75W 250-550mA one4all Ip PRE | 300 mA | 80 V | 150 V | 45.0 W | 49.9 W | 218 mA | 80 °C | -25 ... +60 °C | 16.67 kΩ |
| LCA 75W 250-550mA one4all Ip PRE | 325 mA | 80 V | 150 V | 48.8 W | 53.7 W | 233 mA | 80 °C | -25 ... +55 °C | 15.38 kΩ |
| LCA 75W 250-550mA one4all Ip PRE | 350 mA | 80 V | 150 V | 52.5 W | 57.5 W | 249 mA | 80 °C | -25 ... +55 °C | 14.29 kΩ |
| LCA 75W 250-550mA one4all Ip PRE | 375 mA | 80 V | 150 V | 56.3 W | 61.3 W | 265 mA | 80 °C | -25 ... +55 °C | 13.33 kΩ |
| LCA 75W 250-550mA one4all Ip PRE | 400 mA | 80 V | 150 V | 60.0 W | 65.2 W | 281 mA | 80 °C | -25 ... +55 °C | 12.50 kΩ |
| LCA 75W 250-550mA one4all Ip PRE | 425 mA | 80 V | 150 V | 63.8 W | 69.2 W | 298 mA | 80 °C | -25 ... +50 °C | 11.76 kΩ |
| LCA 75W 250-550mA one4all Ip PRE | 450 mA | 80 V | 150 V | 67.5 W | 73.2 W | 315 mA | 80 °C | -25 ... +50 °C | 11.11 kΩ |
| LCA 75W 250-550mA one4all Ip PRE | 475 mA | 80 V | 150 V | 71.3 W | 77.1 W | 331 mA | 80 °C | -25 ... +50 °C | 10.53 kΩ |
| LCA 75W 250-550mA one4all Ip PRE | 500 mA | 80 V | 150 V | 75.0 W | 81.3 W | 350 mA | 80 °C | -25 ... +50 °C | 10.00 kΩ |
| LCA 75W 250-550mA one4all Ip PRE | 525 mA | 80 V | 143 V | 75.0 W | 81.3 W | 349 mA | 80 °C | -25 ... +50 °C | 9.52 kΩ |
| LCA 75W 250-550mA one4all Ip PRE | 550 mA | 80 V | 136 V | 75.0 W | 81.2 W | 349 mA | 80 °C | -25 ... +50 °C | 0.00 kΩ |

① Valid at 100 % dimming level.

② Depending on the selected output current.

③ Depending on the DALI traffic at the interface.

④ Valid for immediate change of power supply type otherwise the starting time is valid.

⑤ Output current is mean value.

⑥ The table only lists a number of possible operating points but does not cover each single point. The output current can be set within the total value range in 1-mA-steps.

⑦ Not compatible with I-SELECT (generation 1). Calculated resistor value.

I-SELECT 2 PLUG PRE / EXC

Accessory

**Product description**

- _ Ready-for-use resistor to set output current value
- _ Compatible with LED driver featuring I-select 2 interface; not compatible with I-SELECT (generation 1)
- _ Resistor is base insulated
- _ Resistor power 0.25 W
- _ Current tolerance $\pm 2\%$ additional to output current tolerance
- _ Compatible with LED driver series PRE and EXC

Example of calculation

- _ $R [k\Omega] = 5 V / I_{out} [mA] \times 1000$
- _ E96 resistor value used
- _ Resistor value tolerance $\leq 1\%$; resistor power $\geq 0.1 W$; base insulation necessary
- _ When using a resistor value beyond the specified range, the output current will automatically be set to the minimum value (resistor value too big), respectively to the maximum value (resistor value too small)

Website

<http://www.tridonic.com/28001106>

**Ordering data**

| Type | Article number | Colour | Marking | Current | Resistor value | Packaging, bag | Weight per pc. |
|--------------------------|----------------|--------|---------|---------|------------------|----------------|----------------|
| I-SELECT 2 PLUG 250MA BL | 28001106 | Blue | 0250 mA | 250 mA | 20.00 k Ω | 10 pc(s). | 0.001 kg |
| I-SELECT 2 PLUG 275MA BL | 28001107 | Blue | 0275 mA | 275 mA | 18.20 k Ω | 10 pc(s). | 0.001 kg |
| I-SELECT 2 PLUG 300MA BL | 28001108 | Blue | 0300 mA | 300 mA | 16.50 k Ω | 10 pc(s). | 0.001 kg |
| I-SELECT 2 PLUG 325MA BL | 28001109 | Blue | 0325 mA | 325 mA | 15.40 k Ω | 10 pc(s). | 0.001 kg |
| I-SELECT 2 PLUG 350MA BL | 28001110 | Blue | 0350 mA | 350 mA | 14.30 k Ω | 10 pc(s). | 0.001 kg |
| I-SELECT 2 PLUG 375MA BL | 28001111 | Blue | 0375 mA | 375 mA | 13.30 k Ω | 10 pc(s). | 0.001 kg |
| I-SELECT 2 PLUG 400MA BL | 28001112 | Blue | 0400 mA | 400 mA | 12.40 k Ω | 10 pc(s). | 0.001 kg |
| I-SELECT 2 PLUG 425MA BL | 28001251 | Blue | 0425 mA | 425 mA | 11.80 k Ω | 10 pc(s). | 0.001 kg |
| I-SELECT 2 PLUG 450MA BL | 28001113 | Blue | 0450 mA | 450 mA | 11.00 k Ω | 10 pc(s). | 0.001 kg |
| I-SELECT 2 PLUG 475MA BL | 28001252 | Blue | 0475 mA | 475 mA | 10.50 k Ω | 10 pc(s). | 0.001 kg |
| I-SELECT 2 PLUG 500MA BL | 28001114 | Blue | 0500 mA | 500 mA | 10.00 k Ω | 10 pc(s). | 0.001 kg |
| I-SELECT 2 PLUG 525MA BL | 28001960 | Blue | 0525 mA | 525 mA | 9.53 k Ω | 10 pc(s). | 0.001 kg |
| I-SELECT 2 PLUG 550MA BL | 28001115 | Blue | 0550 mA | 550 mA | 9.09 k Ω | 10 pc(s). | 0.001 kg |
| I-SELECT 2 PLUG MAX BL | 28001099 | Blue | MAX | MAX | 0.00 k Ω | 10 pc(s). | 0.001 kg |

1. Standards

EN 55015
 EN 61000-3-2
 EN 61000-3-3
 EN 61347-1
 EN 61347-2-13
 EN 62384
 EN 61547
 EN 62386-101 (DALI-2)
 EN 62386-102 (DALI-2)
 EN 62386-207 (DALI-2, including part 251, 252, 253)
 According to EN 50172 for use in central battery systems
 According to EN 60598-2-22 suitable for emergency lighting installations

2. Thermal details and lifetime

2.1 Expected lifetime

| Expected lifetime | | | | | | | |
|----------------------------------|----------------|----------|-------------|-------------|----------|----------|----------|
| Type | Output current | ta | 40 °C | 45 °C | 50 °C | 55 °C | 60 °C |
| LCA 75W 250-550mA one4all Ip PRE | 250 – 300 mA | tc | 60 °C | 65 °C | 70 °C | 75 °C | 80 °C |
| | | Lifetime | > 100,000 h | > 100,000 h | 96,000 h | 70,000 h | 52,000 h |
| PRE | > 300 – 400 mA | tc | 65 °C | 70 °C | 75 °C | 80 °C | x |
| | | Lifetime | > 100,000 h | > 100,000 h | 77,000 h | 58,000 h | x |
| | > 400 – 550 mA | tc | 70 °C | 75 °C | 80 °C | x | x |
| | | Lifetime | 100,000 h | 75,000 h | 55,000 h | x | x |

The LED driver is designed for a lifetime stated above under reference conditions and with a failure probability of less than 10 %.

The relation of tc to ta temperature depends also on the luminaire design.

If the measured tc temperature is approx. 5 K below tc max., ta temperature should be checked and eventually critical components (e.g. ELCAP) measured. Detailed information on request.

3. Installation / wiring

3.1 Circuit diagram

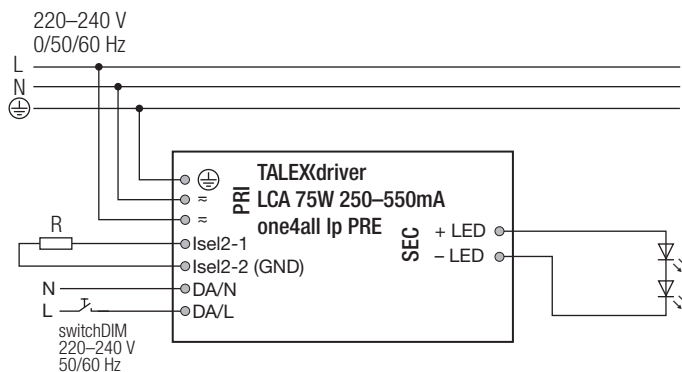
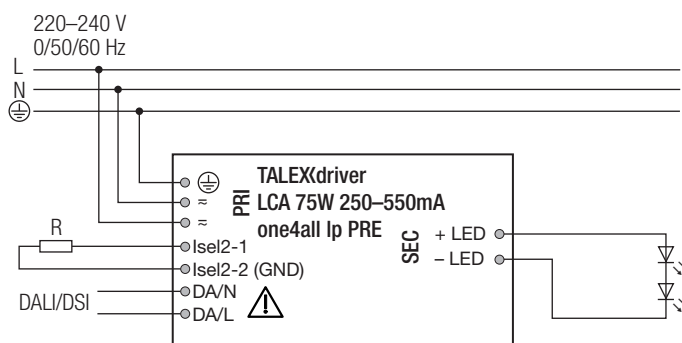

For wiring in dimming operation with ready2mains refer to the ready2mains Gateway datasheet.

3.2 Wiring type and cross section

For wiring use solid wire from 0.5 – 1.5 mm². Strip 8 – 9 mm of insulation from the cables to ensure perfect operation of terminals.

LED module/LED driver/supply

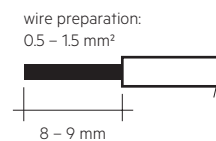

3.3 Loose wiring

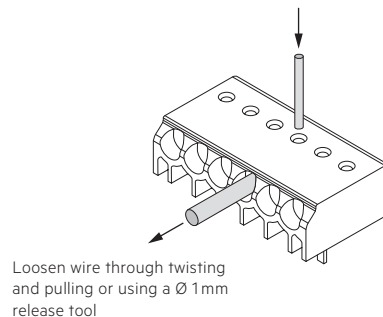

3.4 Wiring guidelines

- The cables should be run separately from the mains connections and mains cables to ensure good EMC conditions.
- The LED wiring should be kept as short as possible to ensure good EMC. The max. secondary cable length is 2 m (4 m circuit), this applies for LED output as well as for I-SELECT 2.
- Secondary switching is not permitted.
- The LED driver has no inverse-polarity protection on the secondary side. Wrong polarity can damage LED modules with no inverse-polarity protection.
- Wrong wiring of the LED driver can lead to malfunction or irreparable damage.
- To avoid the damage of the Driver, the wiring must be protected against short circuits to earth (sharp edged metal parts, metal cable clips, louver, etc.).

3.5 Hot plug-in

Hot plug-in is not supported due to residual output voltage of > 0 V. When connecting an LED load, restart the device to activate the LED output. This can be done via mains reset or via interface (DALI, DSI, switchDIM, ready2mains).

3.6 Earth connection

The earth connection is conducted as protection earth (PE). The LED driver can be earthed via earth terminal or metal housing. If the LED driver will be earthed, protection earth (PE) has to be used. There is no earth connection required for the functionality of the LED driver. Earth connection is recommended to improve following behaviour:

- Electromagnetic interferences (EMI)
- LED glowing at stand-by
- Transmission of mains transients to the LED output

In general it is recommended to earth the LED driver if the LED module is mounted on earthed luminaire parts respectively heat sinks and thereby representing a high capacity against earth.

3.7 I-SELECT 2 resistors connected via cable

For details see:
http://www.tridonic.com/com/en/download/technical/LCA_PRE_LC_EXC_ProductManual_en.pdf

4. Electrical values

4.1 Operating window

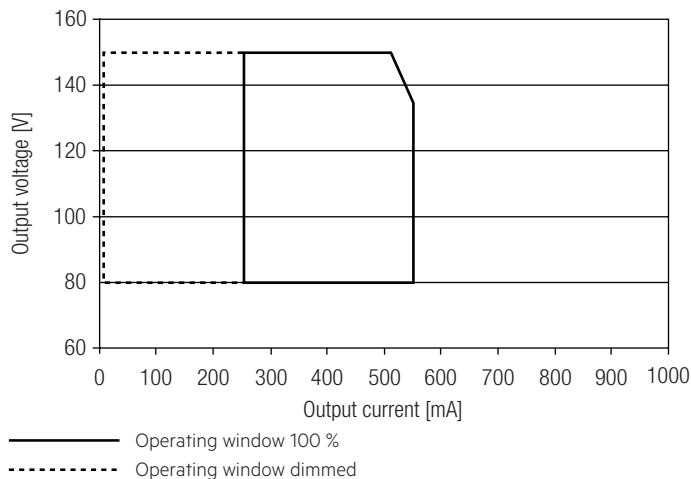

Make sure that the LED driver is operated within the given window under all operating conditions. Special attention needs to be paid at dimming and DC emergency operation as the forward voltage of the connected LED modules varies with the dimming level, due to the implemented amplitude dimming technology. Coming below the specified minimum output voltage of the LED driver may cause the device to shut-down. See chapter "6.9 DC operation" for more information.

4.2 Efficiency vs load

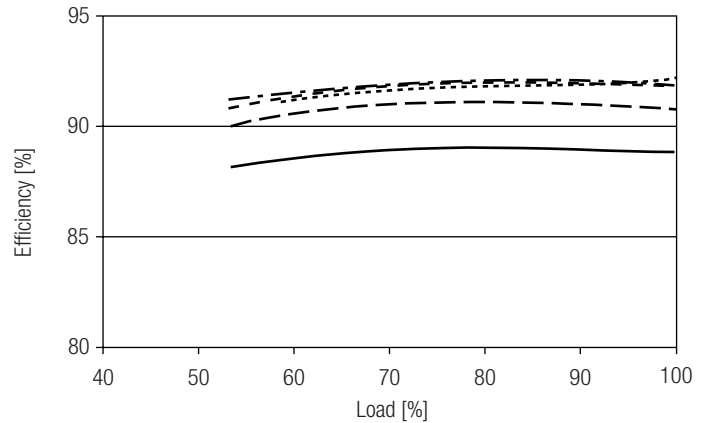

4.3 Power factor vs load

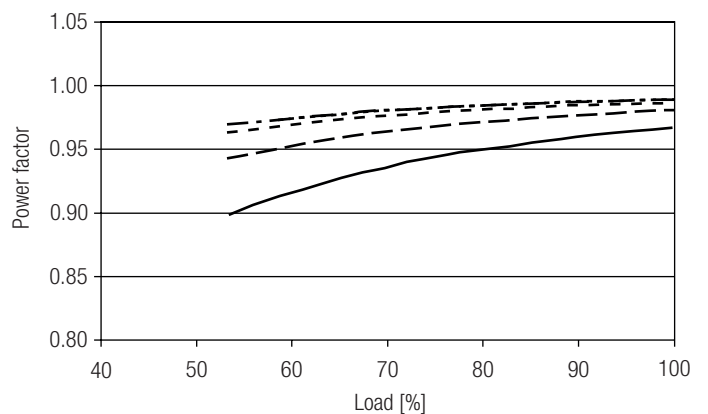

4.4 THD vs load

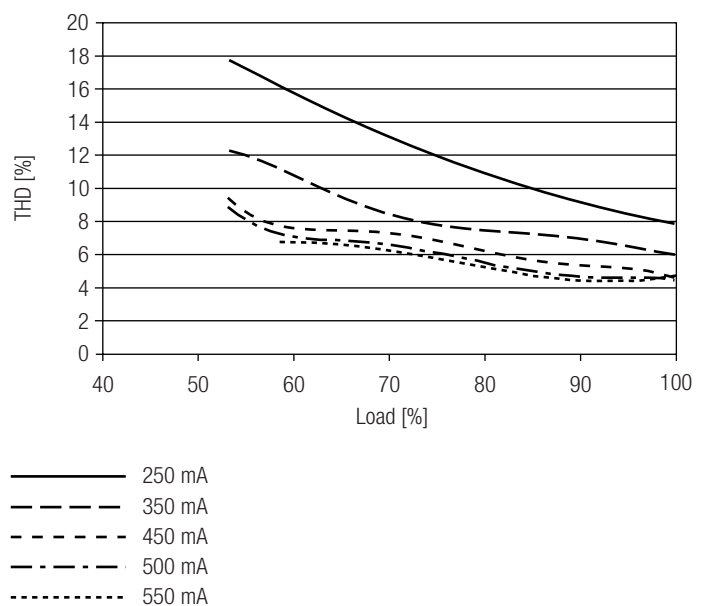

100 % load corresponds to the max. output power (full load) according to the table on page 2.

4.5 Maximum loading of automatic circuit breakers in relation to inrush current

| Automatic circuit breaker type | C10 | C13 | C16 | C20 | B10 | B13 | B16 | B20 | Inrush current | |
|---|---------------------|---------------------|---------------------|---------------------|---------------------|---------------------|---------------------|---------------------|----------------|-------------|
| Installation \varnothing | 1.5 mm ² | 1.5 mm ² | 2.5 mm ² | 2.5 mm ² | 1.5 mm ² | 1.5 mm ² | 2.5 mm ² | 2.5 mm ² | I_{max} | time |
| LCA 75W 250-550mA one4all Ip PRE | 21 | 28 | 35 | 45 | 13 | 17 | 21 | 27 | 29 A | 155 μ s |

These are max. values calculated out of inrush current! Please consider not to exceed the maximum rated continuous current of the circuit breaker.

Calculation uses typical values from ABB series S200 as a reference.

Actual values may differ due to used circuit breaker types and installation environment.

4.6 Harmonic distortion in the mains supply (at 230 V / 50 Hz and full load) in %

| | THD | 3. | 5. | 7. | 9. | 11. |
|---|-----|------|-----|-----|-----|-----|
| LCA 75W 250-550mA one4all Ip PRE | < 5 | < 12 | < 4 | < 3 | < 3 | < 2 |

4.7 Dimming

Dimming range 1% to 100 %

Digital control with:

- DSI signal: 8 bit Manchester Code
Speed 1% to 100% in 1.4 s
 - DALI signal: 16 bit Manchester Code
Speed 1% to 100% in 0.2 s
- Programmable parameter:
Minimum dimming level
Maximum dimming level
Default minimum = 1%
Programmable range $1\% \leq \text{MIN} \leq 100\%$
Default maximum = 100%
Programmable range $100\% \geq \text{MAX} \geq 1\%$

Dimming curve is adapted to the eye sensitiveness.

Dimming is realized by amplitude dimming.

4.8 Dimming characteristics

Digital dimming value

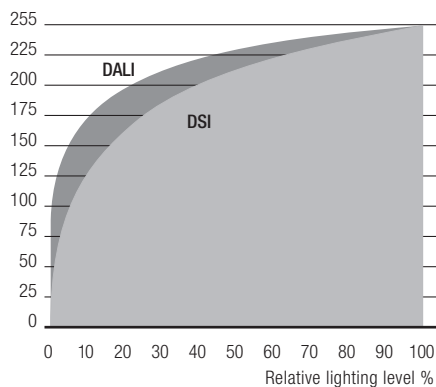

Dimming characteristics as seen by the human eye

5.1 Software / programming

With appropriate software and interface different functions can be activated and various parameters can be configured in the LED driver. The Driver supports the following software and interfaces:

Software / hardware for configuration:

- companionSUITE (deviceGENERATOR, deviceCONFIGURATOR, deviceANALYSER)
- masterCONFIGURATOR
- ready2mains Programmer

Interfaces for data transfer:

- Control input DALI
- Control input ready2mains

5.2 Control input DALI

The control input is non-polar for digital control signals (DALI). The control signal is not SELV. The control cable has to be installed in accordance to the requirements of low voltage installations.

Digital control with:

- DALI signal: 16 bit
- DSI signal: 8 bit

5.3 Control input ready2mains (L, N)

The digital ready2mains protocol is modulated onto the mains signal which is wired to the mains terminal (L and N).

The configuration is done via the ready2mains Programmer, either directly at the Programmer itself or via a respective software tool. For details on the configuration via ready2mains see the technical information of the Programmer and its tools.

Following tools can be used:

- deviceCONFIGURATOR (companionSUITE)
- masterCONFIGURATOR
- ready2mains Programmer

5.4 I-SELECT 2

By inserting a suitable resistor into the I-SELECT 2 interface, the current value can be adjusted. The relationship between output current and resistor value can be found in the chapter "Accessories I-SELECT 2 Plugs". If the resistor is connected by wires a consistent base insulation must be ensured. Furthermore, a max. wire length of 2 m may not be exceeded and potential interferences have to be avoided.

Resistors for the main output current values can be ordered from Tridonic (see accessories).

6. Functions

⊙ companionSUITE:













DALI-USB, ready2mains Programmer

The companionSUITE with deviceGENERATOR, deviceCONFIGURATOR and deviceANALYSER is available via our WEB page:
<https://www.tridonic.com/com/en/products/companionsuite.asp>

◇ masterCONFIGURATOR:

DALI-USB, ready2mains Programmer (in DALI mode)

The masterCONFIGURATOR is available via our WEB page:
<https://www.tridonic.com/com/en/software-masterconfigurator.asp>

| Icon | Function | DALI-2 | ready2mains |
|---|---------------------------------|--------|-------------|
|  | OEM Identification | ⊙ ◇ | ⊙ |
|  | OEM GTIN | ⊙ ◇ | ⊙ |
|  | Luminaire data | ⊙ - | - |
|  | LED current | ⊙ ◇ | ⊙ |
|  | Device operating mode | ⊙ ◇ | ⊙ |
|  | switchDIM | ⊙ ◇ | ⊙ |
|  | corridorFUNCTION | ⊙ ◇ | ⊙ |
|  | Constant light output (CLO) | ⊙ ◇ | ⊙ |
|  | DC level | ⊙ ◇ | ⊙ |
|  | Enhanced power on level (ePOL) | ⊙ ◇ | ⊙ |
|  | DALI default parameters | ⊙ ◇ | - |
|  | Scenes and groups | ⊙ ◇ | - |
|  | fade2zero | ⊙ - | - |
|  | Power-up fading | ⊙ - | - |
|  | Intelligent voltage guard (IVG) | ⊙ ◇ | ⊙ |
|  | Dimming curve | ⊙ - | - |

6.1 OEM Identification



The OEM (Original Equipment Manufacturer) can set his own identification number.

DALI Part 251: Memory bank 1 extension.

6.2 OEM GTIN



The Original Equipment Manufacturer (OEM) can set his own Global Trade Item Number (GTIN).

DALI Part 251: Memory bank 1 extension.

6.3 Luminaire data



This function provides the asset management with accurate data about the luminaire.

DALI Part 251: Memory bank 1 extension.

6.4 LED current



The LED output current must be adapted to the connected LED module. The value is limited by the current range of the respective device.

The output current of the LED driver can be adjusted in a certain range. For adjustment there are 4 options available.

Option 1: DALI

Adjustment is done by companionSUITE or by masterCONFIGURATOR.

Option 2: I-SELECT 2

By inserting a suitable resistor into the I-SELECT 2 interface, the current value can be adjusted.

Option 3: ready2mains

Adjustment is done by the ready2mains programmer and the corresponding configuration software (see ready2mains documentation).

The priority for current adjustment methods is DALI (highest priority), I-SELECT 2 and ready2mains (lowest priority).

6.5 Device operating mode



A Tridonic Driver supports several control signals. These control signals are automatically detected and the mode is adapted. If only one special device mode is required, this mode can be selected. "Automatic detection" is the default setting.

6.6 switchDIM



Integrated switchDIM function allows a direct connection of a pushbutton for dimming and switching.

Brief push (< 0.6 s) switches LED driver ON and OFF. The dimm level is saved at power-down and restored at power-up. When the pushbutton is held, LED modules are dimmed. After repush the LED modules are dimmed in the opposite direction.

In installations with LED drivers with different dimming levels or opposite dimming directions (e.g. after a system extension), all LED drivers can be synchronized to 50 % dimming level by a 10 s push.

Use of pushbutton with indicator lamp is not permitted.

switchDIM 2

Version 2 has now the possibility to define different fade times used for short button press events. So the fade time to set memory level (if wake-up from standby) as well as the fade time to switch off can now be configured.

6.7 corridorFUNCTION



With the corridorFUNCTION and a commercially available motion detector, it is easy to adapt the lighting in one area to its use.

That is, when the area is entered by a person, the lighting dims instantly to the desired brightness and is available in full strength.

After the area is left by the person, the brightness dims slowly to a smaller value or switches off completely.

The individual parameters of the desired profile, such as brightness values or delay times, can be adjusted flexibly and individually.

6.8 Constant Light Output (CLO)



With this function the light output of the LED module can be kept equal over the lifetime.

The light output of an LED module reduces over the course of its lifetime.

The Constant Light Output (CLO) function compensates for this natural decline by constantly increasing the output current of the LED driver throughout its lifetime.

CLO shall be achieved by limitation of the LED current at the commissioning of the LED driver and providing a linear interpolation of the current over the time, depending on the data points given by the user.

6.9 DC operation



In emergency light systems with a central battery supply the DC recognition function uses the input voltage to detect if emergency mode is present.

The LED driver then automatically switches to DC mode and dims the light to the defined DC level.

Without DC recognition different and more complex solutions would have to be applied in order to detect emergency mode.

DC recognition is integrated in the device as standard.

No additional commissioning is necessary for activation.



This is a safety-relevant parameter.

The setting is relevant for the dimensioning of the central battery system.

The LED driver is designed to operate on DC voltage and pulsed DC voltage. For a reliable operation, make sure that also in DC emergency operation the LED driver is run within the specified conditions as stated in chapter "4.1 operating window".

Light output level in DC operation: programmable 1 – 100 %
(factory default = 15 %, EOF_i = 0.13).

The voltage-dependent input current of Driver incl. LED module is depending on the used load.

The voltage-dependent no-load current of Driver (without or defect LED module) is for:

AC: < 32.8 mA

DC: < 2.8 mA

In DC operation dimming mode can be activated.

If Dimming on DC is activated the requirements of the DC recognition function are ignored.

Even if DC is detected, the LED driver continues to behave as in AC mode

- The present dimming level is retained
- An emergency light level defined for the DC recognition function (DC level) is ignored
- Control signals via DALI continue to be executed

If Dimming on DC is activated then emergency mode is not recognised. The device no longer automatically switches to the emergency light level.

6.10 Enhanced power on level (ePOL)



The Enhanced Power On Level parameter defines the power level that is set automatically when power is restored after a power failure.

The Enhanced Power On Level can be set to a fixed value (0 – 100 %) or can recall the memory value.

The memory value is the last value the LED driver was set to before the power failure.

This value applies not only in DALI device operating mode, but also in the device operating mode switchDIM.

6.11 DALI default parameters



In order for all luminaires to react the same for each operation (switching, dimming, scene recall ...), these values must be set the same.

These DALI standard parameters are supported by every DALI-2 device.

6.12 Scenes and groups



Each device can be a member of up to 16 groups.

Also, 16 different scene values can be stored in each device.

6.13 fade2zero



When the Driver is switched off, fade2zero allows a smooth dimming down to almost zero.

Activate the fade2zero function when programming with companionSUITE and set a DALI fade time. fade2zero only works if the minimum dimming level of the Driver is the default value.

The device then dims to far below the limit of its working window (dimming range).

This function is deactivated by default.

6.14 Power-up fading



The power-up function offers the opportunity to modify the on behavior.

The time for fading on can be adjusted in a range of 0.2 to 16 seconds.

According to this value, the device dims from 0 % up to the power-on level.

By factory default no fading time is set (= 0 seconds).

6.15 Dimming curve



DALI:

The desired dimming behaviour is selected via two different dimming curves (logarithmic or linear).

The default setting of the dimming behaviour is logarithmic.

7. Protective features

7.1 Intelligent temperature guard (ITG)



The Intelligent temperature guard (ITG) function provides effective protection against thermal overloads by slowly reducing the output if a defined internal temperature is exceeded.

The reduction of overtemperatures takes place in small steps every two minutes. As soon as the temperature drops again, the output power is gradually increased every 10 minutes.

On DC operation this function is deactivated to fulfill emergency requirements.

7.2 Intelligent Voltage Guard (IVG)



The Intelligent Voltage Guard (IVG) function warns of possible damage due to overvoltage or undervoltage.

The mains voltage is constantly monitored and if necessary appropriate responses are made:

- If the mains voltage is too low (< 70 V), the LED driver is switched off.
- At a mains voltage between 70 and 140 V, the LED driver switches off and on again on a non-cyclic basis.
- In case of an overvoltage (> 318 V), the LED driver sends feedback via DALI.

7.3 Short-circuit behaviour

In case of a short-circuit at the LED output the LED output is switched off. After restart of the LED driver the output will be activated again. The restart can either be done via mains reset or via interface (DALI, DSI, switchDIM, ready2mains)

7.4 No-load operation

The LED driver will not be damaged in no-load operation. The output will be deactivated and is therefore free of voltage. If a LED load is connected the device has to be restarted before the output will be activated again.

7.5 Overload protection

If the maximum load is exceeded by a defined internal limit, the LED driver turns off the LED output.

After restart of the LED driver the output will be activated again.

The restart can either be done via mains reset or via interface (DALI, DSI, switchDIM, ready2mains).

7.6 Insulation between terminals

| Insulation | Mains | PE | LED | DALI |
|------------|-------|-------|-------|-------|
| Mains | – | basic | basic | basic |
| PE | basic | – | basic | basic |
| LED | basic | basic | – | basic |
| DALI | basic | basic | basic | – |

basic ... represents basic insulation.

8. Miscellaneous

8.1 Insulation and electric strength testing of luminaires

Electronic devices can be damaged by high voltage. This has to be considered during the routine testing of the luminaires in production.

According to IEC 60598-1 Annex Q (informative only!) or ENEC 303-Annex A, each luminaire should be submitted to an insulation test with 500 V_{DC} for 1 second. This test voltage should be connected between the interconnected phase and neutral terminals and the earth terminal.

The insulation resistance must be at least 2 MΩ.

As an alternative, IEC 60598-1 Annex Q describes a test of the electrical strength with 1500 V_{AC} (or 1.414 x 1500 V_{DC}). To avoid damage to the electronic devices this test must not be conducted.

8.2 Control terminals



There is a risk of electric shock when touching these terminals in case of failure.

8.3 Conditions of use and storage

Humidity: 5 % up to max. 85 %, not condensed (max. 56 days/year at 85 %)

Storage temperature: -40 °C up to max. +80 °C

The devices have to be acclimatised to the specified temperature range (ta) before they can be operated.

8.4 Maximum number of switching cycles

All LED driver are tested with 50,000 switching cycles. The actually achieved number of switching cycles is significantly higher.

8.5 Additional information

Additional technical information at www.tridonic.com → Technical Data

Lifetime declarations are informative and represent no warranty claim. No warranty if device was opened.