

ACL LENS 55x280mm

Linear accessories



ACL LENS 55x280mm 60°



ACL LENS 55x280mm DA25°



ACL SHADE 55x280mm UGR

Product description

- _ ACL LENS for LLE 55x280mm
- _ Available with different beam characteristics
- _ Easy mounting with M4 screws
- _ ACL SHADE to reduce UGR
- _ ACL LENS made of PMMA, ACL SHADE made of ABS
- _ Max. permissible temperature 80 °C
- _ Max. permissible tc temperature 75 °C at the LED module
- _ Photometric data available on website

Website

<http://www.tridonic.com/28002206>

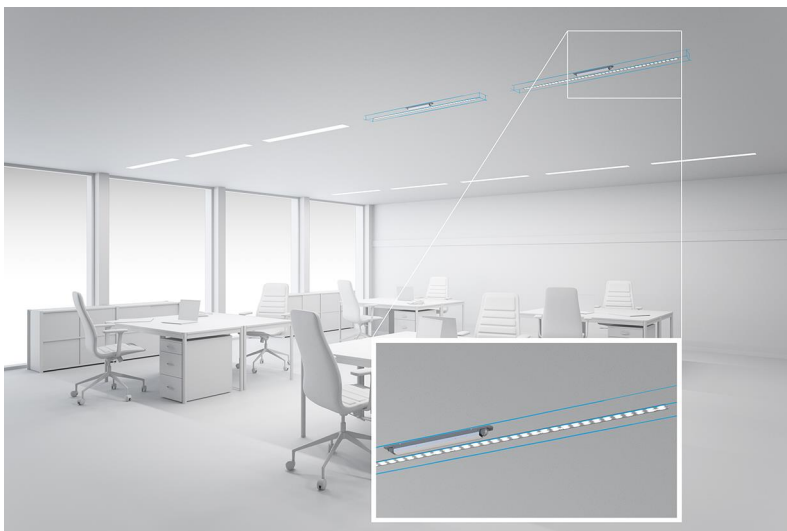

ACL LENS 55x280mm

Linear accessories

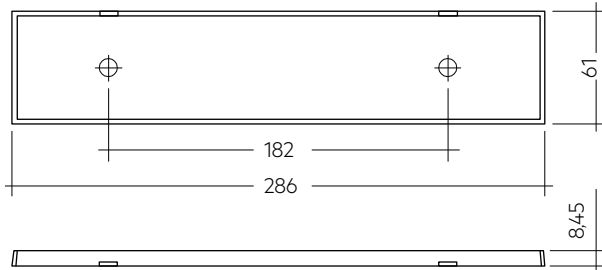

ACL LENS (28002206, 28002207, 28002208)

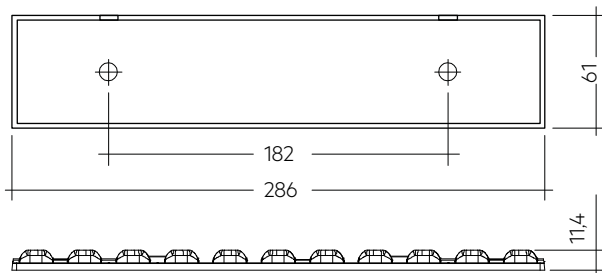

ACL LENS (28002209, 28002210)

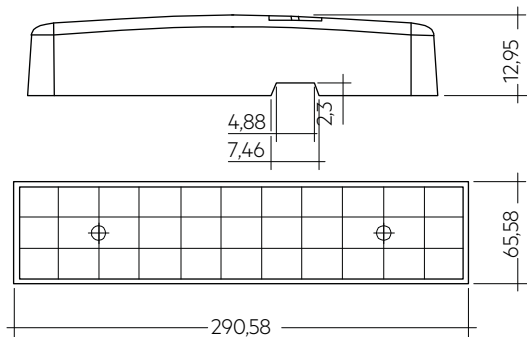

ACL SHADE (28002211)

Ordering data

Type	Article number	Length L	Beam characteristic	Efficiency	Packaging, carton	Weight per pc.
ACL LENS 55X280mm 60°	28002206	286.00 mm	60°	91 %	72 pc(s).	0.088 kg
ACL LENS 55X280mm 90°	28002207	286.00 mm	90°	90 %	72 pc(s).	0.092 kg
ACL LENS 55X280mm 90x45°	28002208	286.00 mm	90x45°	90 %	72 pc(s).	0.091 kg
ACL LENS 55X280mm DA25°	28002209	286.00 mm	double asymmetric 25°	94 %	60 pc(s).	0.072 kg
ACL LENS 55X280mm A20°	28002210	286.00 mm	asymmetric 20°	93 %	60 pc(s).	0.058 kg
ACL SHADE 55X280mm UGR	28002211	290.58 mm	UGR improving	-	60 pc(s).	0.027 kg

1. Photometric characteristics

1.1 Light distribution for ACL LENS 55x280mm 60°

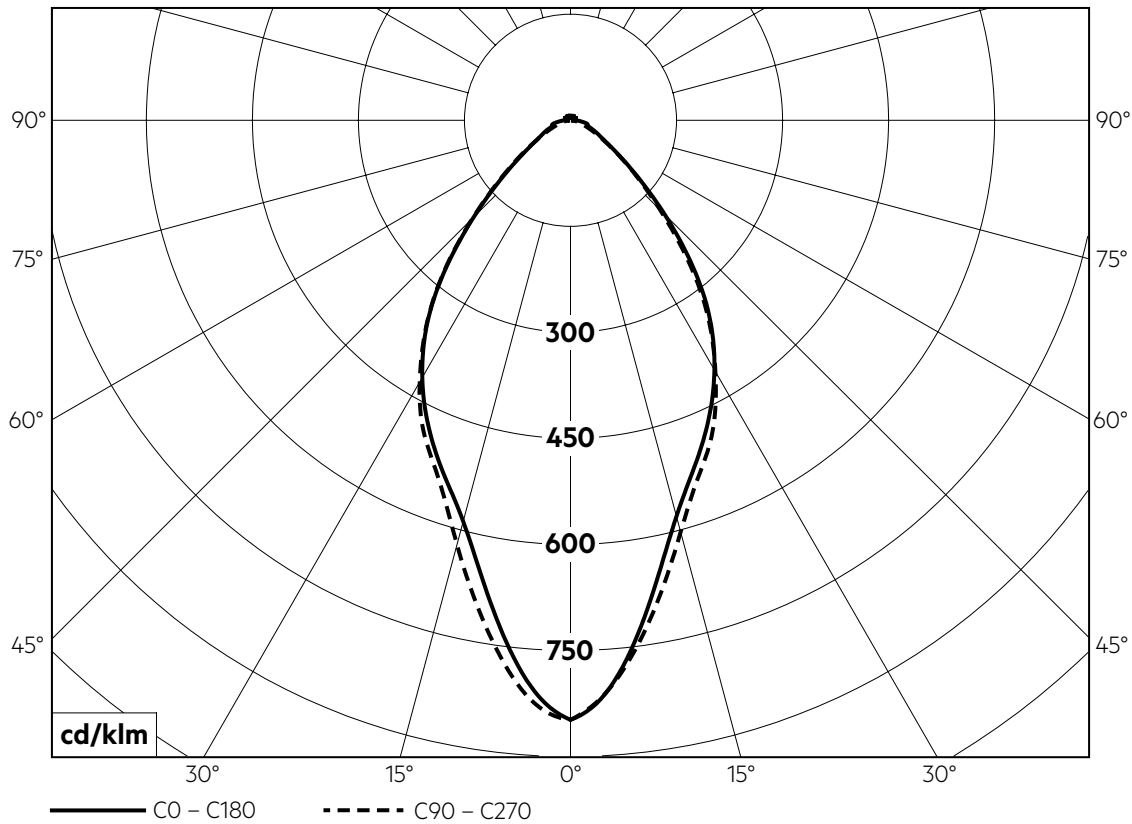

1.2 Light distribution for ACL LENS 55x280mm 60° with ACL SHADE

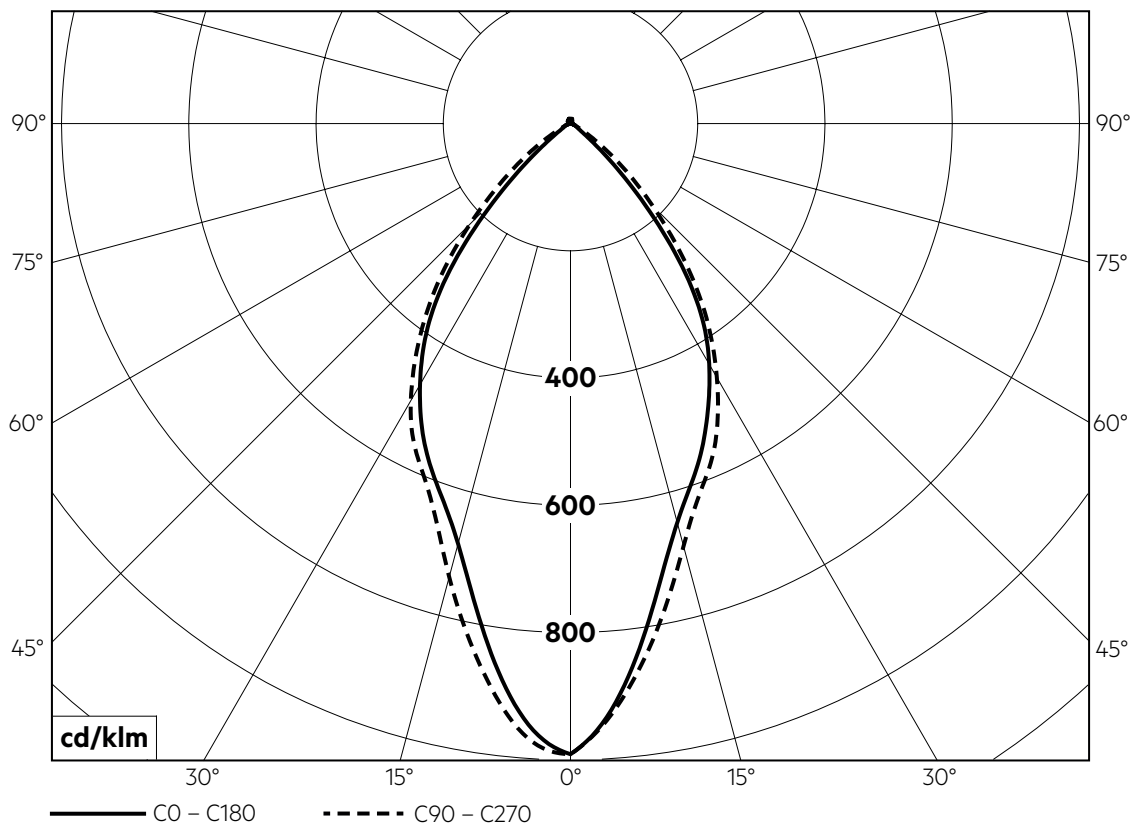

1.3 Light distribution for ACL LENS 55x280mm 90°

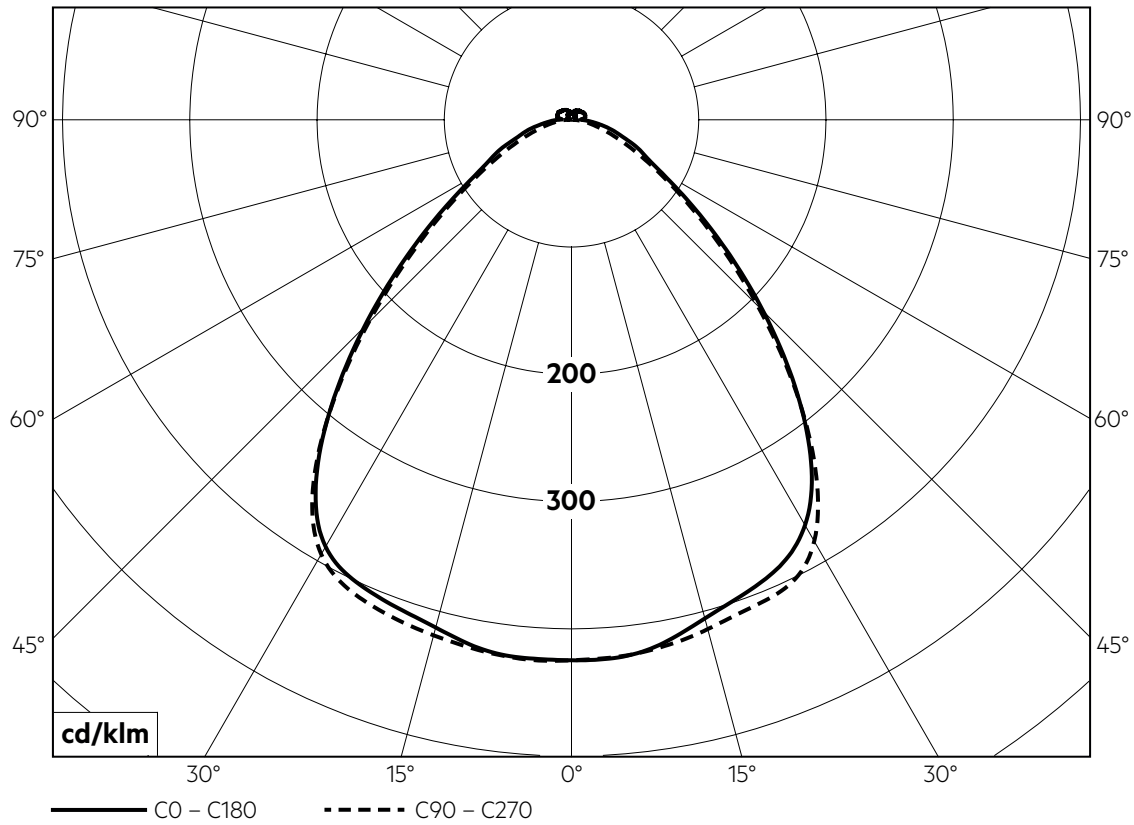

1.4 Light distribution for ACL LENS 55x280mm 90° with ACL SHADE

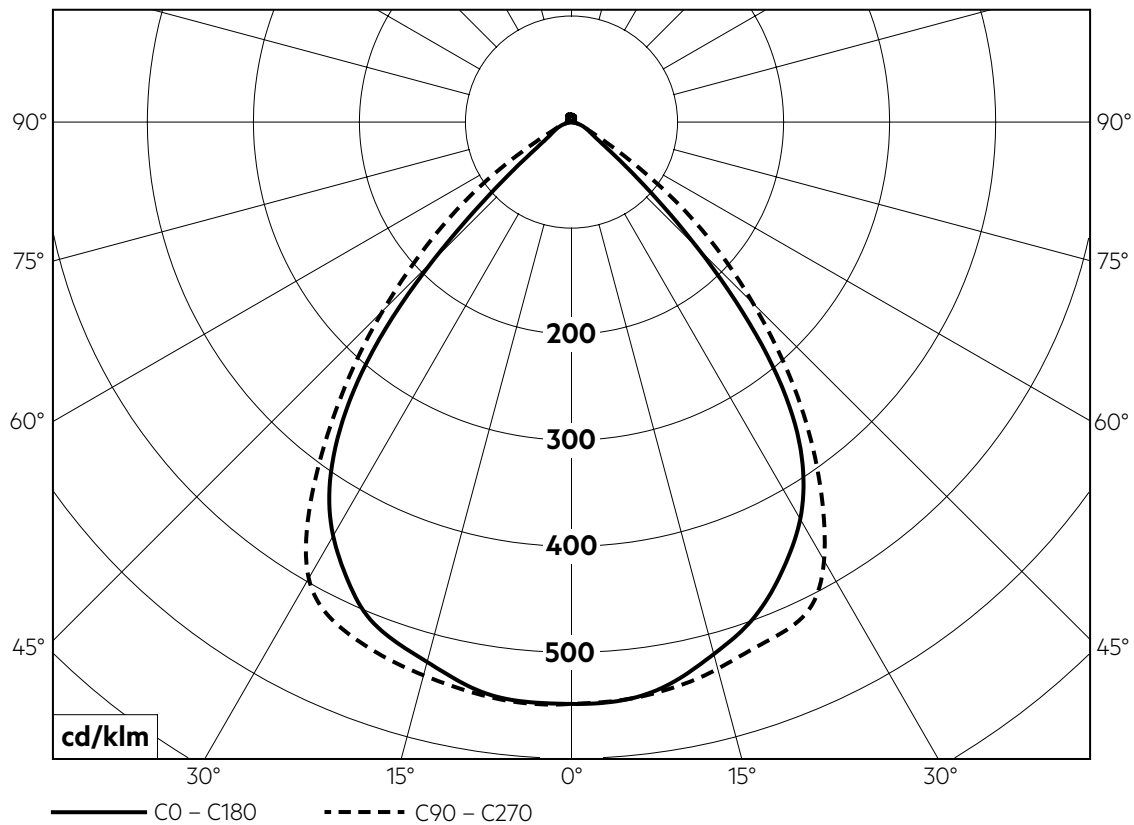

1.5 Light distribution for ACL LENS 55x280mm 90x45°

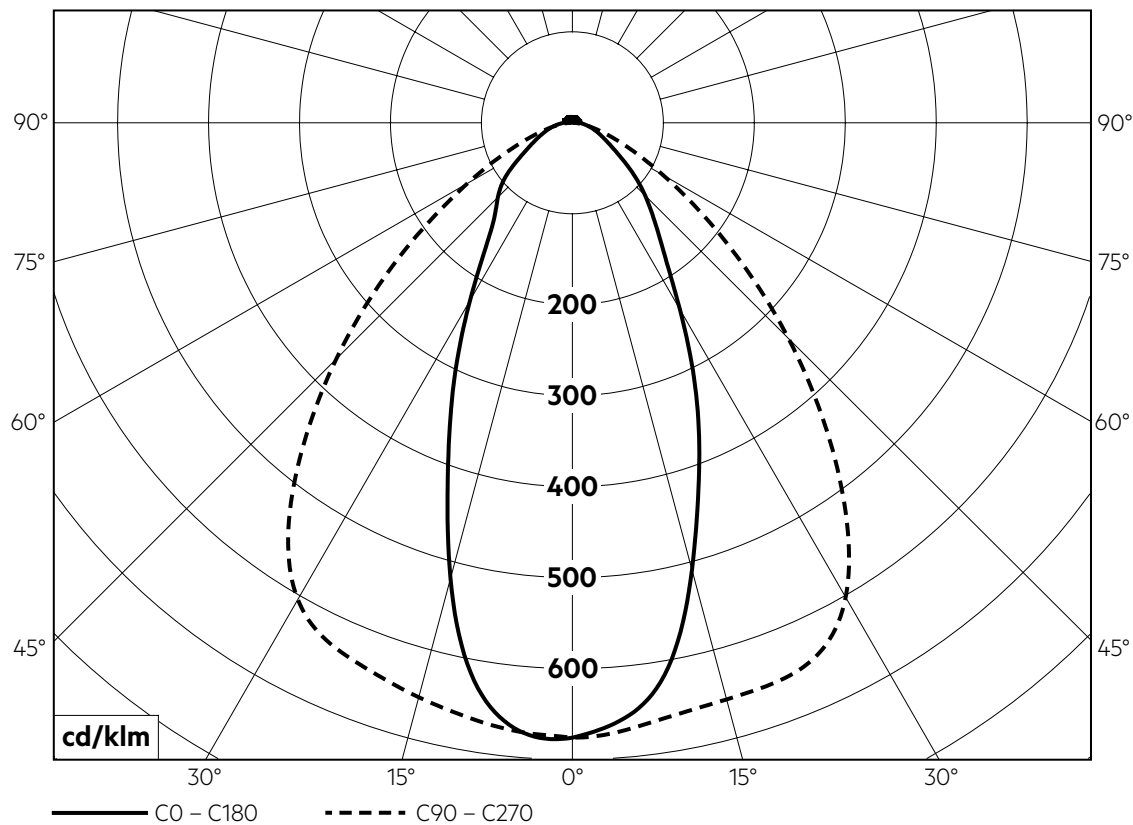

1.6 Light distribution for ACL LENS 55x280mm 90x45° with ACL SHADE

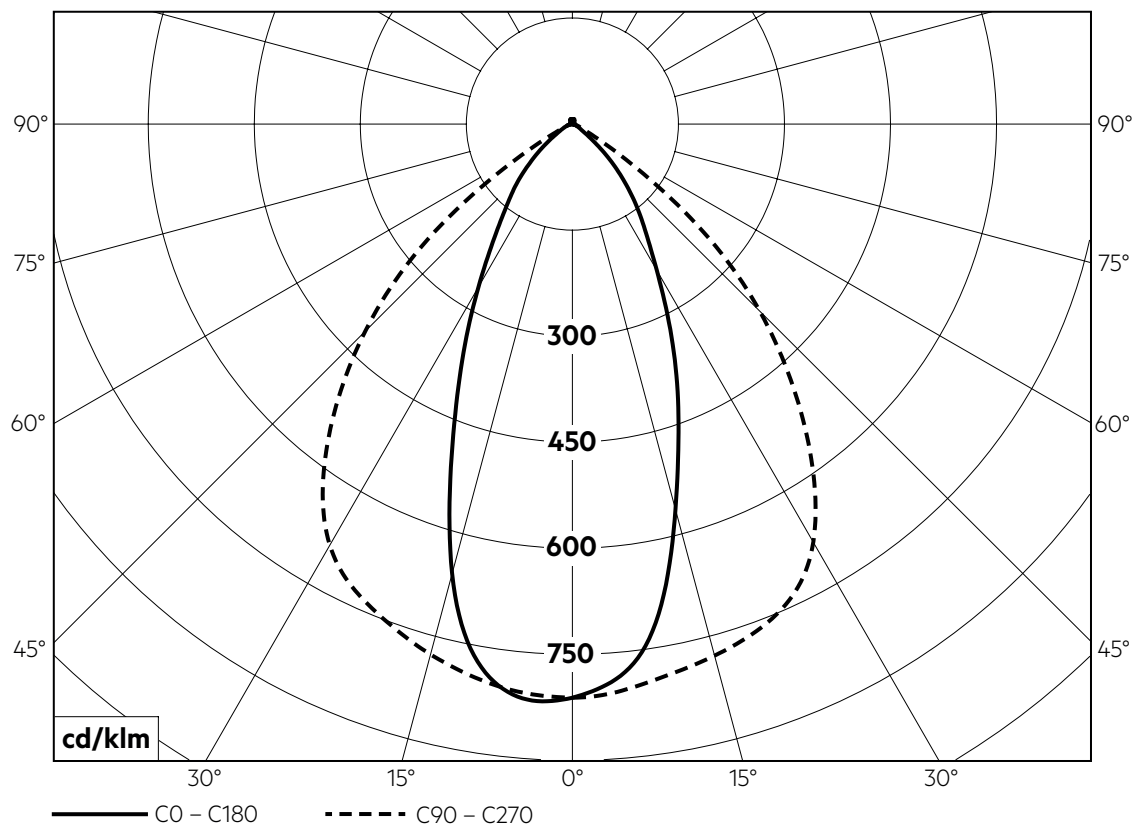

1.7 Light distribution for ACL LENS 55x280mm DA 25°

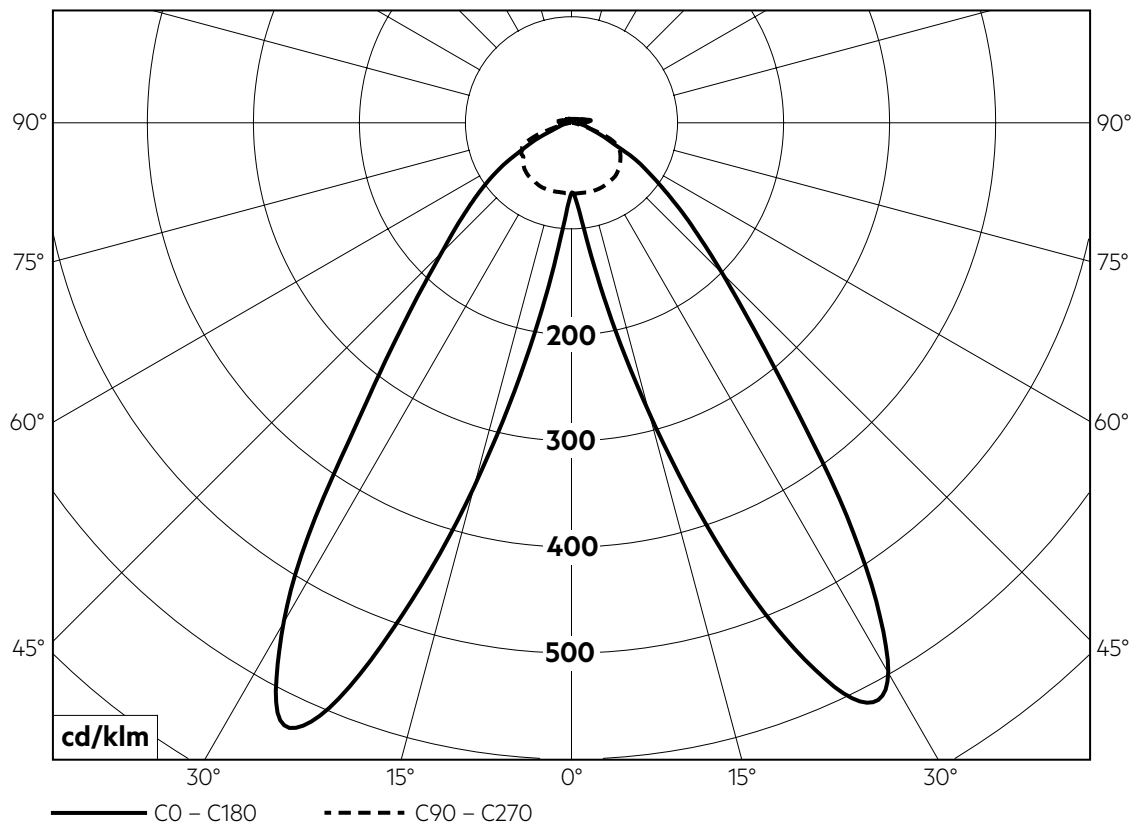

1.8 Light distribution for ACL LENS 55x280mm A 20°

