

ACL LENS 55x280mm

Zubehör Linear



ACL LENS 55x280mm 60°



ACL LENS 55x280mm DA25°



ACL SHADE 55x280mm UGR

Produktbeschreibung

- _ ACL LENS für LLE 55x280mm
- _ Verfügbar in verschiedenen Abstrahlcharakteristiken
- _ Nur für SELV-Anwendungen
- _ Einfache Montage mit M4 Schrauben
- _ ACL SHADE reduziert UGR
- _ ACL LENS aus PMMA, ACL SHADE aus ABS
- _ Max. zulässige Temperatur 80 °C
- _ Photometrische Daten verfügbar über Webseite

Website

<http://www.tridonic.com/28002206>

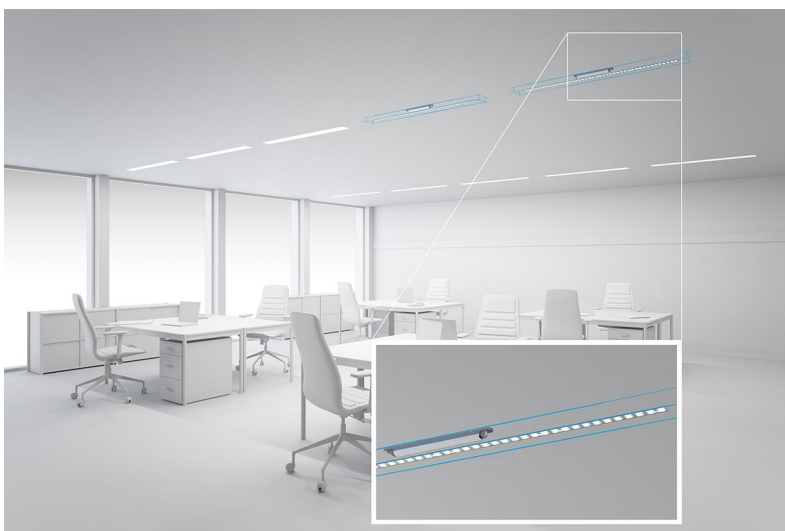

ACL LENS 55x280mm

Zubehör Linear

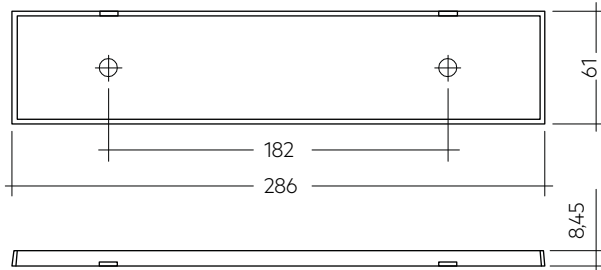

ACL LENS (28002206, 28002207, 28002208)

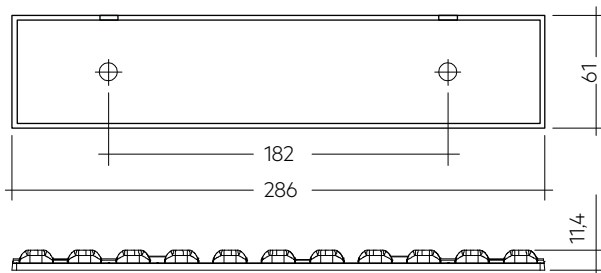

ACL LENS (28002209, 28002210)

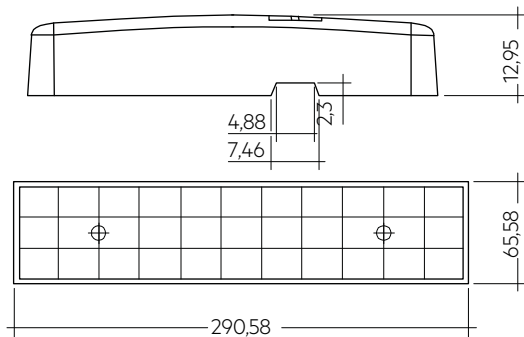

ACL SHADE (28002211)

Bestelldaten

Typ	Artikelnummer	Länge L	Abstrahlcharakteristik	Wirkungsgrad	Verpackung Karton	Gewicht pro Stk.
ACL LENS 55X280mm 60°	28002206	286,00 mm	60°	91 %	72 Stk.	0,088 kg
ACL LENS 55X280mm 90°	28002207	286,00 mm	90°	90 %	72 Stk.	0,092 kg
ACL LENS 55X280mm 90x45°	28002208	286,00 mm	90x45°	90 %	72 Stk.	0,091 kg
ACL LENS 55X280mm DA25°	28002209	286,00 mm	doppelt asymmetrisch 25°	94 %	60 Stk.	0,072 kg
ACL LENS 55X280mm A20°	28002210	286,00 mm	asymmetrisch 20°	93 %	60 Stk.	0,058 kg
ACL SHADE 55X280mm UGR	28002211	290,58 mm	UGR verbessernd	–	60 Stk.	0,027 kg

1. Photometrische Eigenschaften

1.1 Lichtverteilung für ACL LENS 55x280mm 60°

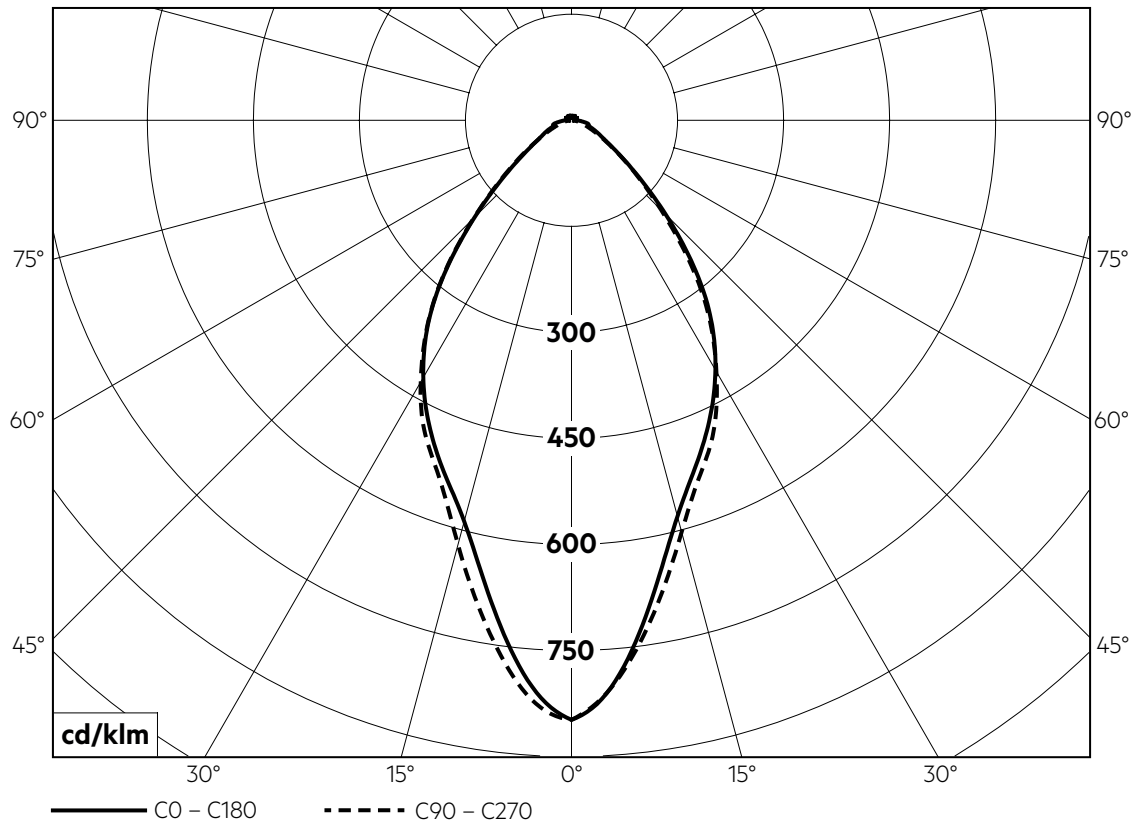

1.2 Lichtverteilung für ACL LENS 55x280mm 60° mit ACL SHADE

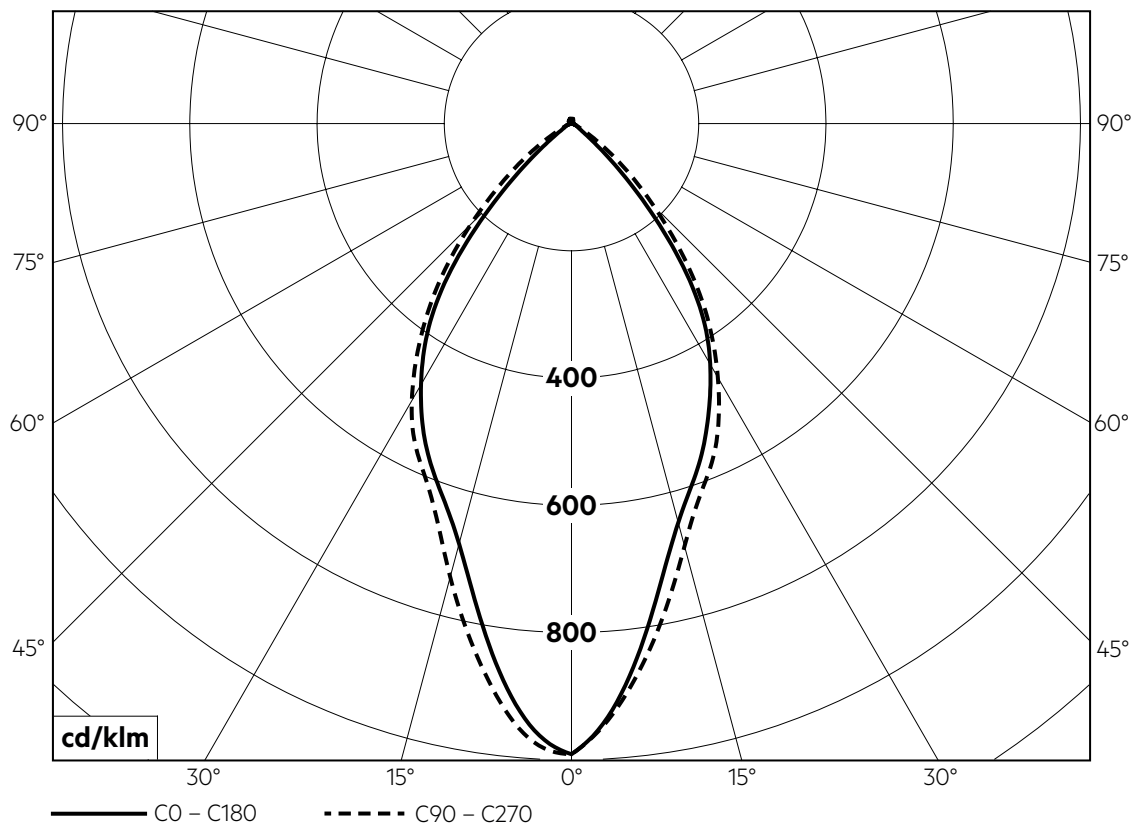

1.3 Lichtverteilung für ACL LENS 55x280mm 90°

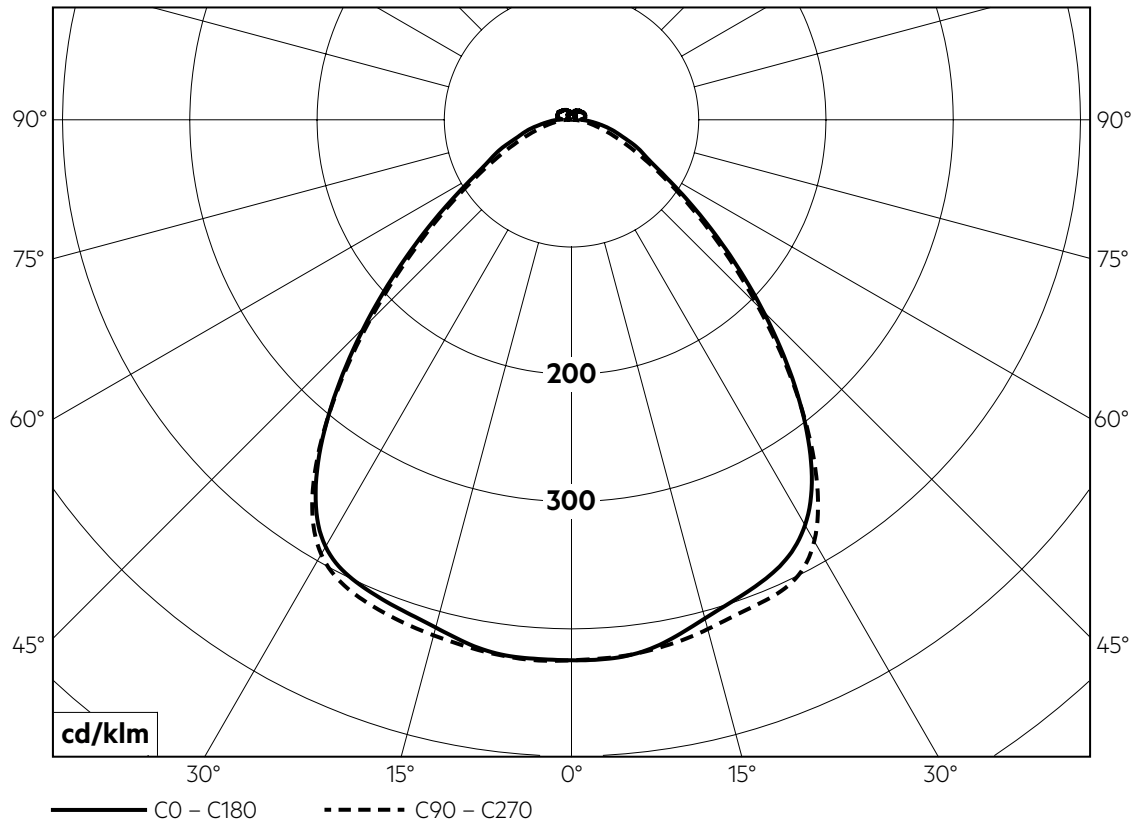

1.4 Lichtverteilung für ACL LENS 55x280mm 90° mit ACL SHADE

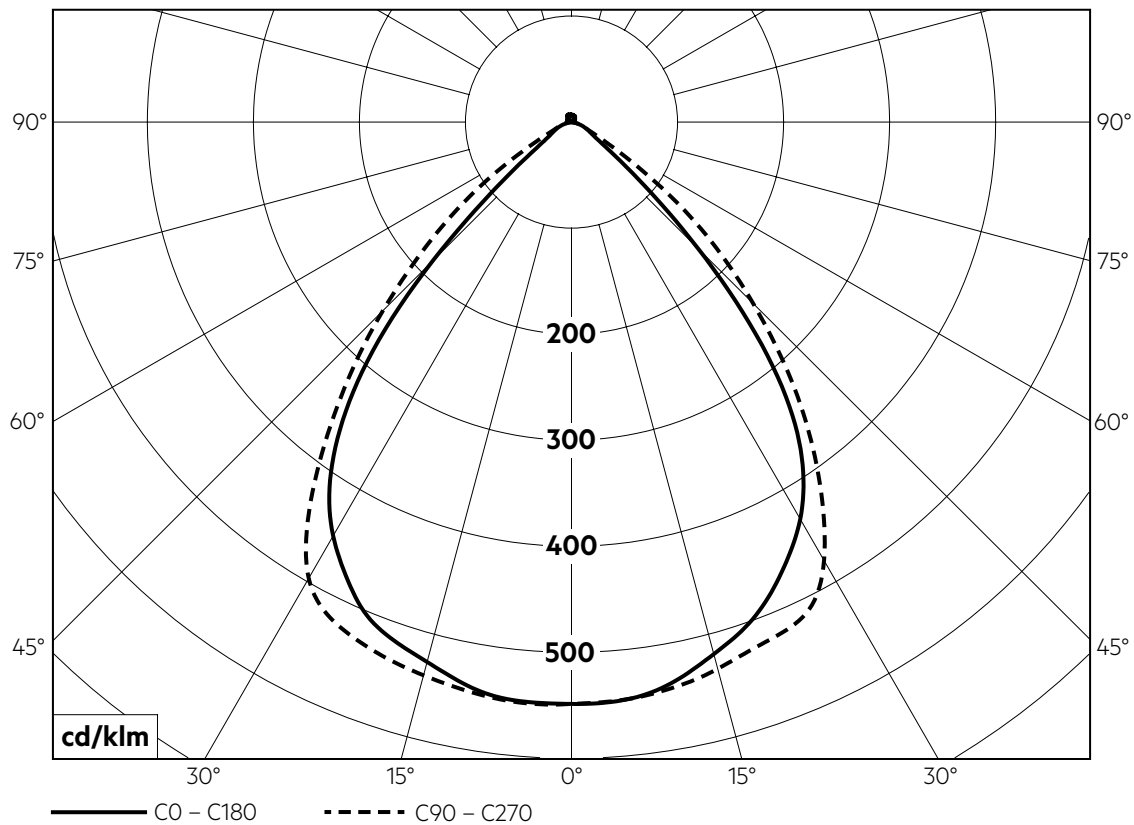

1.5 Lichtverteilung für ACL LENS 55x280mm 90x45°

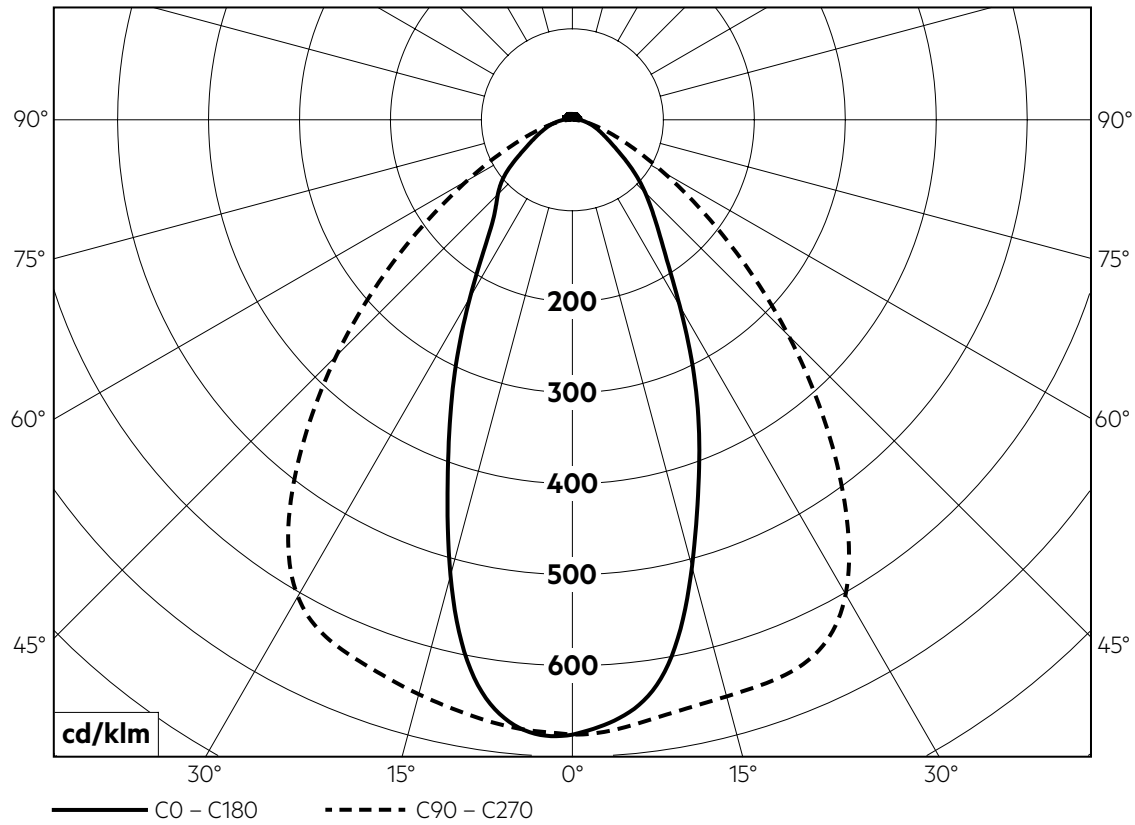

1.6 Lichtverteilung für ACL LENS 55x280mm 90x45° mit ACL SHADE

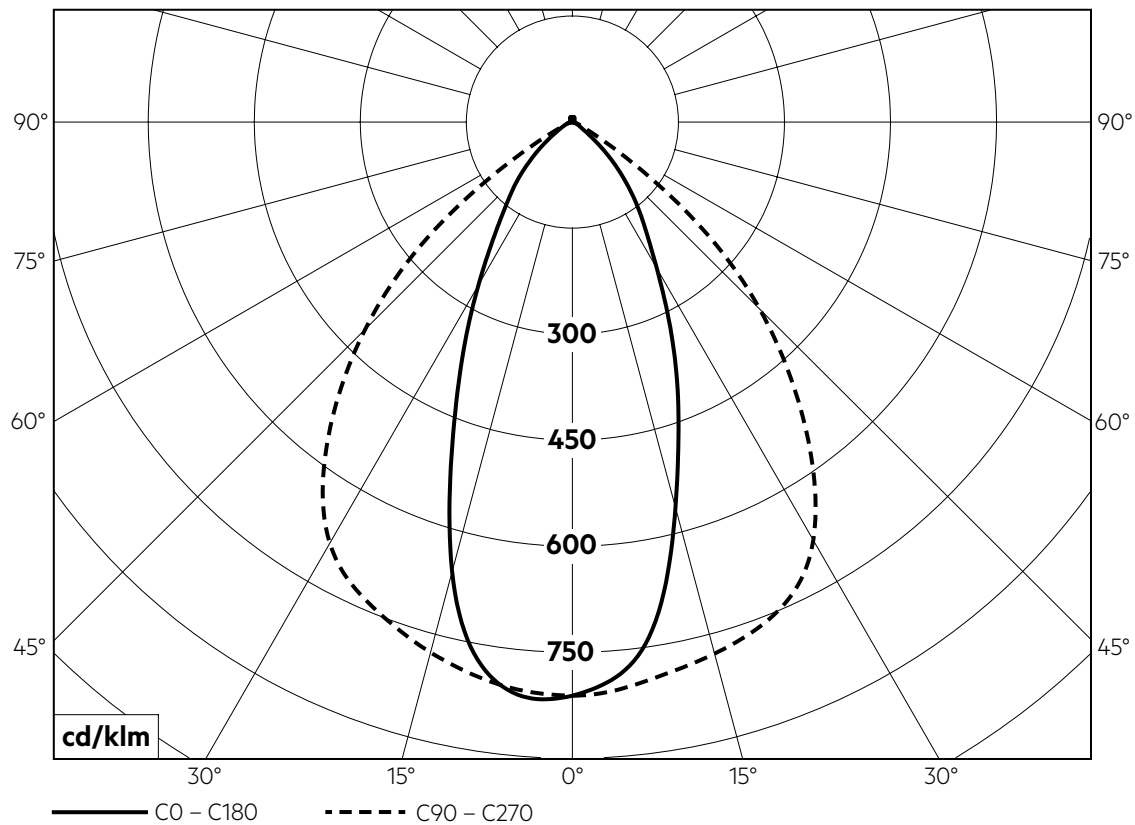

1.7 Lichtverteilung für ACL LENS 55x280mm DA 25°

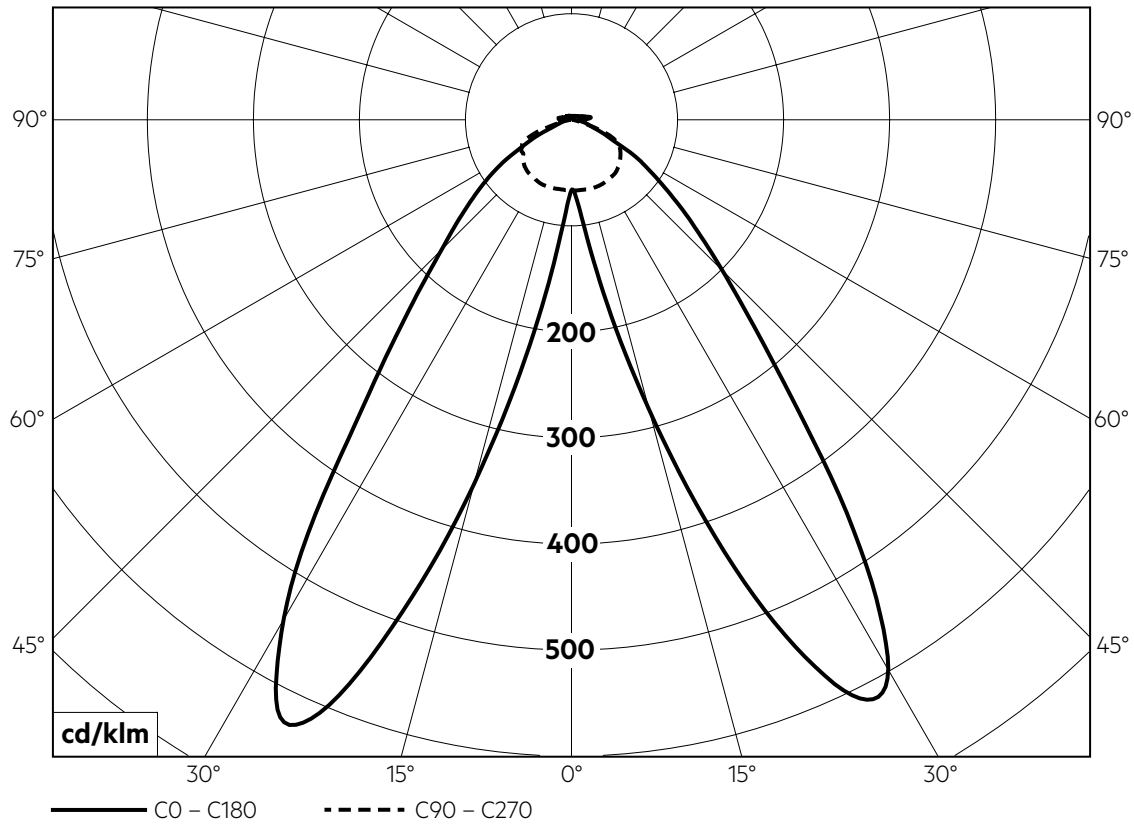

1.8 Lichtverteilung für ACL LENS 55x280mm A 20°

